

Issue:
10.10.2017
21763200

KNX Valve drive 3 Order No. 2176 00



Table of Contents

1	Product definition	4
1.1	Product catalogue	4
1.2	Function	4
2	Installation, electrical connection and operation	5
2.1	Safety instructions	5
2.2	Device components	6
2.3	Mounting and electrical connection	8
2.4	Commissioning	11
2.5	Display functions	12
3	Technical data	13
4	Software description	14
4.1	Software specification	14
4.2	Valve drive "A0301x" software	15
4.2.1	Scope of functions	15
4.2.2	Notes on software	18
4.2.2.1	Device generations and using the application programs	18
4.2.2.2	Firmware upgrade	19
4.2.3	Object table	20
4.2.3.1	Objects for the valve drive	20
4.2.3.2	Objects for the input	24
4.2.3.3	Objects for disabling the input	26
4.2.3.4	Objects for room temperature measurement	27
4.2.3.5	Objects for the room temperature controller	29
4.2.3.6	Objects for the temperature limiting value	45
4.2.4	Functional description	46
4.2.4.1	General settings	46
4.2.4.2	Valve drive	47
4.2.4.2.1	Self-adjustment	49
4.2.4.2.2	Data formats for command values	50
4.2.4.2.3	Operating mode	51
4.2.4.2.4	Status function	52
4.2.4.2.5	Monitoring of the command value / Emergency operation	56
4.2.4.2.6	Valve rinsing	58
4.2.4.2.7	Forced position	62
4.2.4.2.8	Command value limit	63
4.2.4.2.9	Limiting value message	65
4.2.4.2.10	Fault message	66
4.2.4.2.11	Application examples	67
4.2.4.3	Input	69
4.2.4.3.1	Switching	69
4.2.4.3.2	Dimming	71
4.2.4.3.3	Venetian blind	72
4.2.4.3.4	Value transmitter / Light scene extension	74
4.2.4.3.5	Disabling function of the input	78
4.2.4.3.6	Remote sensor	79

4.2.4.3.7	Temperature limit	80
4.2.4.4	Room temperature measurement	81
4.2.4.5	Room temperature controller	85
4.2.4.5.1	Operating modes and operating mode change-over	85
4.2.4.5.2	Control algorithms and calculation of command values	88
4.2.4.5.3	Adapting the control algorithms	95
4.2.4.5.4	Operating mode switch-over	98
4.2.4.5.5	Temperature setpoints	107
4.2.4.5.6	Command value and status output	119
4.2.4.5.7	Fan controller	127
4.2.4.5.8	Disable functions of the room temperature controller	134
4.2.4.6	Temperature limiting value	135
4.2.5	Parameters	136
4.2.5.1	General	136
4.2.5.2	Valve drive	137
4.2.5.3	Input	152
4.2.5.4	Room temperature measurement	178
4.2.5.5	Room temperature controller	182
4.2.5.6	Temperature limiting value	207
5	Appendix	211
5.1	Index	211

1 Product definition

1.1 Product catalogue

Product name: Valve drive 3

Use: Actuator

Design: Motor actuator

Order No. 2176 00

1.2 Function

The device is suitable for mounting on all thermostat valve bases, e.g. radiators, convectors, heating circuit distributors for underfloor heating, etc. It is used for room temperature control. The device is operated without maintenance and is intended for direct connection to the KNX.

According to the control signal (internal or external) sent by a room temperature controller, the drive proportionally moves the heating valve into a position between "Closed" and "Open".

The automatic valve rinsing prevents the calcification or sticking of a valve which has not been activated for some time. The device can perform valve rinsing cyclically or triggered by an external KNX telegram. The drive then causes the activated valve to run through the full valve stroke for a preset period of time. If necessary, the intelligent valve rinsing can be enabled. In so doing, cyclical rinsing using the full stroke is only executed when a defined minimum command value was not exceeded during device operation.

The device possesses a binary input, allowing a push-button/switching state to be read in without potential and then telegrams to be transmitted to the KNX. This could be telegrams for switching, dimming, for Venetian blind control or value transmitter application (dimmer value transmitter, light scene extension, temperature or brightness value transmitter). For example, window contacts, as well as normal push-buttons and switches, can be connected, which either have an effect or can be used to trigger other functions. Thanks to a special protection circuit, this binary input is also suitable for the connection of an external sensor.

The device can be used for single-room temperature control. Depending on the operating mode, current temperature setpoint and room temperature, a variable for heating or cooling control can be transmitted to the KNX for the control circuit. In addition to the heating or cooling basic level, activating an additional heater and/or cooling unit means that an additional heating or cooling unit can be used. In this connection, you can set the temperature setpoint difference between the basic and the additional level by a parameter in the ETS. For major deviations between the temperature setpoint and the actual temperature, you can activate this additional level to heat up or cool down the room faster. You can assign different control algorithms to the basic and additional stages.

For heating and cooling functions, you can select continuous or switching PI or switching 2-point feedback control algorithms.

The controller distinguishes between different operating modes (comfort, standby, night, frost/heat protection) each with their own temperature setpoints for heating or cooling.

The device can measure the room temperature independently of the room temperature controller function. The temperature values of the internal sensor, the connected remote sensor or those received via KNX can execute the room temperature measurement function individually. However, temperature detection can also be performed through a combination of two of the measuring methods. The temperature value can be calibrated in the device parameters.

A malfunction (fault) on the device is signalled by the Programming LED flashing. Alarming via a KNX telegram is also possible as an option.

Commissioning of the device using ETS of version 4.2 or higher is also possible.

2 Installation, electrical connection and operation

2.1 Safety instructions



Electrical devices may only be mounted and connected by electrically skilled persons.

Serious injuries, fire or property damage possible. Please read and follow manual fully.

2.2 Device components

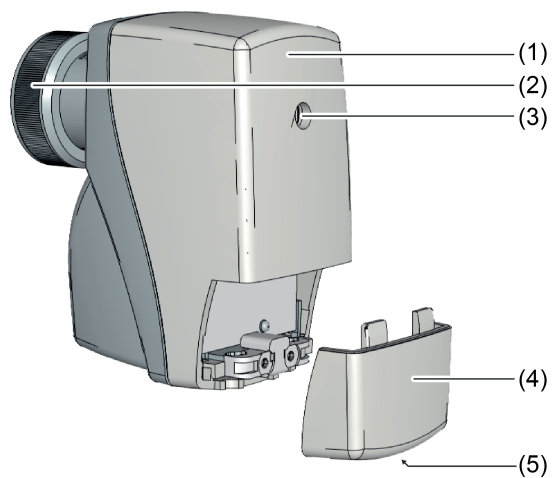

Figure 1: Device components, front view

- (1) Valve drive
- (2) Knurled nut M30×1.5
- (3) Programming/status LED
- (4) Cover
- (5) Screw



Figure 2: Device components, top view

- (6) Valve setting display

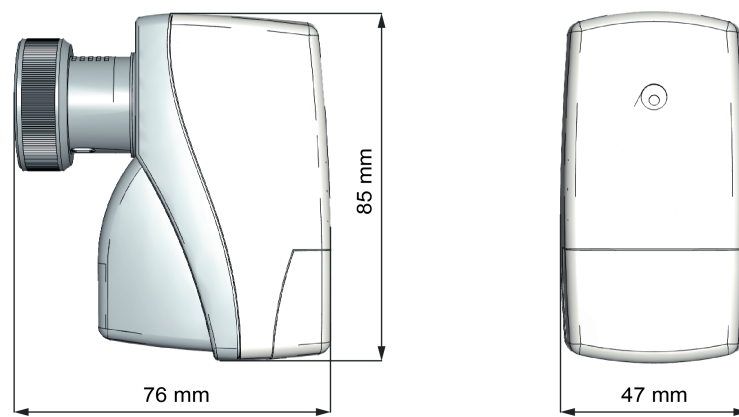

Figure 3: Device components, dimensions

2.3 Mounting and electrical connection



DANGER!

Electrical shock when live parts are touched.

Electrical shocks can be fatal.

Before working on the device, disconnect the power supply and cover up live parts in the working environment.

Fitting the device

- i** Select the installation location, so that an ambient temperature of 0 ... +50°C is maintained.
- i** After valve mounting, check the ease of movement of the valve seal in the valve seat by pushing in the valve spindle.
- i** To mount the device and remove the cover (4), ensure there is a free area of approx. 170 mm above the device.
- i** For safety reasons, the device may not be arranged so that it is hanging under the valve.

Before device mounting, ensure that there is no differential pressure in the valve body. The device can be mounted after the pipeline has cooled down.

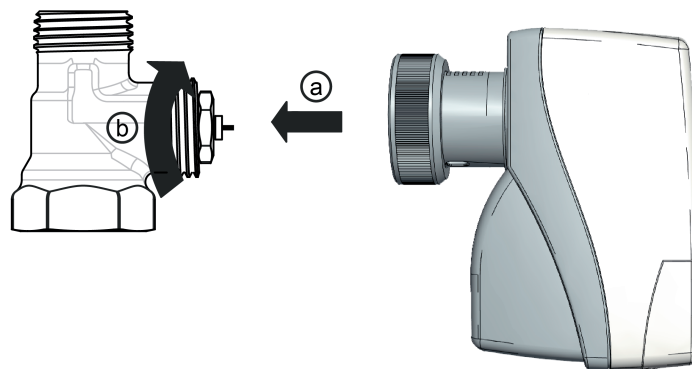

Figure 4: Fitting the device

Precondition: Device is deenergised.

Precondition: Matching thermostat valve base and knurled nut (2).

- Attach the device to the thermostat valve base (a) with slight pressure.
- Knurled nut (Figure 1) and hand-tighten it (b).
- i** The M30x1.5 mm knurled nut matches all standard valve base types. The device fits the thermostat valve bases of make Heimeier. Adapters of make Heimeier can be used for valve bases of other manufacturers. No function guarantee can be accepted for this.

Dismantling the device

Before device dismantling, ensure that there is no differential pressure in the valve body. The device can be dismantled after the pipeline has cooled down.

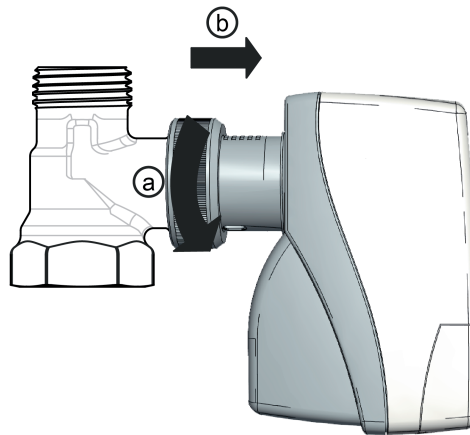

Figure 5: Dismantling the device

Precondition: Device is deenergised.

- Knurled nut (Figure 1)(a).
- Remove the device from the thermostat valve base (b).

Connecting the device

Precondition: Device is mounted on a thermostat valve base.

- Connect the device with connection cable (7) to KNX.
 - Secure the connection cable (7) of the mounted device at the junction point using strain relief, e.g. in the cable outlet.
- i** Observe the cable routing. The connection cable may not come into prolonged contact with elements conducting heat, e.g. heating pipe or radiator.

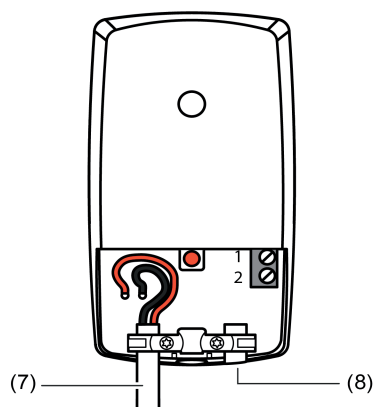

Figure 6: Device components with opened cover

- (7) Connecting cable
- (8) Blanking plug

Connecting an external contact / remote sensor

Use a cable with a diameter of 5 mm to connect a potential-free contact or a remote sensor for room temperature measurement.

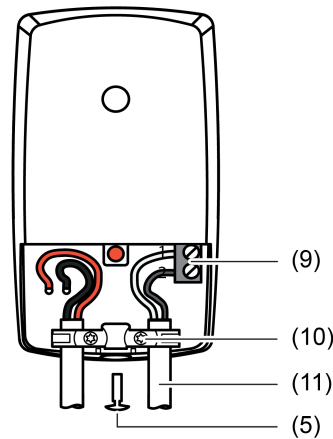

Figure 7: Connection of an external contact / remote sensor

- (5) Screw
- (9) Device connection terminal for potential-free contact or remote sensor ("1" = - / **GND**, "2" = +)
- (10) Strain relief
- (11) Connection cable for potential-free contact or remote sensor

- Slacken the screw (5) with Torx-7 and open the cover (4).
- Slacken the strain relief (10) of the unused cable entry.
- Remove the blanking plug (8).
- Insert the connection cable for the potential-free contact or remote sensor through the open cable entry into the terminal compartment.
- Connect the connection cable to the terminal (9).
- Fix the connecting cable with the strain relief (10).
- Close the cover (4) and tighten the screw (5).

i Observe the cable routing. The connection cable may not come into prolonged contact with elements conducting heat, e.g. heating pipe or radiator.

2.4 Commissioning

Commissioning with the ETS

After mounting and connection of the bus line, the device can be put into operation. The following procedure is generally recommended.

Precondition: The device has been connected to KNX.

- Switch on the bus voltage. Make sure that the bus voltage is available without interruption during the commissioning.

Result: After the bus voltage is switched on, the device automatically performs a self-adjustment (initialisation).

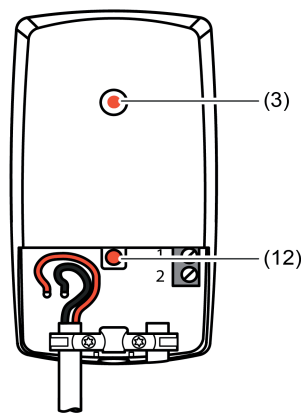

Figure 8: Programming button and LED

(3) Programming/status LED

(12) Programming button

- Configure and program the physical address with the help of the ETS.
- Download the application data with the ETS.

Result: The device is ready for operation.

2.5 Display functions

The Programming/status LED (3) has two display functions:

- Display programming mode (LED lit up permanently)
- Display adjustment error (LED flashing)

3 Technical data

KNX

KNX medium	TP
Commissioning mode	S-mode
Rated voltage KNX	DC 21 ... 32 V SELV
Current consumption KNX	max. 20 mA
Protection class	III

Mechanism

Valve connection	M30×1.5
Stroke	1.0 ... 4.2 mm
Positioning force	80 ... 120 N
Noise emission	max. 28 dB(A)
Dimensions L×W×H	76×47×85 mm

Connecting cable

Cable type	J-YY 1×2×0.6 mm
Cable length of drive	1 m
Number of drives per line	max. 30
Total length per line	max. 30 m
	(Cable length of drive x number of drives)

Connection cable for potential-free contact/remote sensor

Cable length	max. 10 m
single stranded	0.08 ... 1.5 mm ²

Ambient conditions

Degree of protection	IP 40
Ambient temperature	0 ... +50 °C
Storage/transport temperature	-20 ... +70 °C
Relative humidity	5 ... 95 % (No moisture condensation)

4 Software description

4.1 Software specification

ETS search paths: heating, air condition, ventilation / valves / Valve drive 3
 PEI type: "00"_{Hex} / "0"_{Dec}
 PEI connector: no connector

Application:

No.	Short description	Name	Version	from mask version
1	Multifunctional valve drive application: Activation of a thermostat valve. Optional room temperature controller and optional function of a binary input. This version of the application program has an extended range of functions compared to version 1.1.	Valve drive 3 A03012	1.2 for ETS4 Version 4.2 onwards and ETS5	SystemB (07B0)
2	Multifunctional valve drive application: Activation of a thermostat valve. Optional room temperature controller and optional function of a binary input.	Valve drive 3 A03011	1.1 for ETS4 Version 4.2 onwards and ETS5	SystemB (07B0)

4.2 Valve drive "A0301x" software

4.2.1 Scope of functions

General functions

- Limitation of the KNX telegrams per 17 seconds.
- Settable delay after reset or when bus voltage returns.

Functions of the valve drive

- Room temperature control of, for example, radiators, convectors and heating circuit distributors for underfloor heating.
- Works with internal room temperature measurement and internal room temperature controller or with received command values.
- Infinite valve adjustment.
- Status feedback of the actual position of the valve.
- Maintenance-free operation.
- Operating mode of the valve actuation (normal / inverse) can be configured.
- Command value evaluation either as 1-bit switching function (Switching 2-point control) or as 8-bit value (Continuous PI control).
- Optional locking of the valve drive in two forced positions.
- Optional command value limit.
- Optional limit value monitoring.
- Optional command value monitoring/emergency operation
- Automatic valve rinsing as protection against calcification or sticking of a valve which has not been activated for some time.

Functions of the input

- Free assignment of the functions Switching, Dimming, Venetian blind, Dimming value transmitter, Light scene extension without storage function, Light scene extension with storage function, Temperature value transmitter, Brightness value transmitter, Remote sensor or Temperature limiting (underfloor heating).
- Optional disabling function (polarity of disabling object can be set).
- Configurable response on bus voltage return.
- Scope of detail for the "Switching" function:
Two independent switching objects available for the input (switching commands can be configured individually).
Command can be set independently for rising and falling edge (ON, OFF, TOGGLE, no reaction).
Independent cyclical transmission of the switching objects can be selected depending on the edge or depending on the object value.
- Scope of detail for the "Dimming" function:
Single-area and dual-area operation possible.
Time between dimming and switching and also the dimming step width is adjustable.
Telegram repetition and stop telegram transmission possible.
- Scope of detail for the "Venetian blind" function:
Command can be set independently for rising edge (no function, UP, DOWN, TOGGLE).
Operation concept configurable (short – long – short or long – short).
Time adjustable between short-time and long-time operation (only for short – long – short)
Adjustable slat adjustment time (time during which a MOVE command can be terminated by releasing a push-button on the input).
- Scope of detail for the "Value transmitter" function:
Edge (push-button as NO contact, push-button as NC contact, switch) and value for edge can be configured.
Value adjustment for push-button long key-press possible for value transmitter.
For light scene extension with memory function, the scene can also be saved without prior recall.

Function of the room temperature measurement

- Temperature detection using internal sensor, remote sensor or received temperature value.

- Any combination of two temperature detection options (internal sensor and remote sensor, internal sensor and received temperature value, remote sensor and received temperature value) possible.
- Configurable measured value formation for temperature detection.
- Request time of the received temperature value can be set.
- The room temperature measurement (actual value) can be calibrated separately for the internal sensor, for the remote sensor and for the received temperature value using parameters.
- The actual temperature can be transmitted cyclically to the KNX.

Functions of the integrated room temperature controller

- Various operating modes can be activated: Comfort, Standby, Night and Frost/heat protection.
- Each operating mode can be assigned its own temperature-setpoints (for heating and/or cooling).
- Configuring the temperature setpoints as relative (derived from basic setpoint) or absolute (independent setpoint temperatures for each operating mode).
- Comfort extension possible using presence button in Night or Frost/heat protection mode. Configurable duration of the comfort extension.
- Operating mode change-over via a 1-byte object according to KNX or using up to 4 individual 1-bit objects.
- Frost/heat protection switchover via window status or by automatic frost protection.
- Operating modes "Heating", "Cooling", "Heating and cooling" each with or without additional level.
- Various control types can be configured for each heating or cooling level: PI control (permanent or switching PWM) or 2-point feedback control (switching).
- Control parameter for PI controller (if desired: proportional range, reset time) and 2-point controller (hysteresis) adjustable.
- The temperature setpoints for the additional level are derived via a configurable level offset from the values of the basic level.
- Automatic or object oriented switch-over between "heating" and "cooling".
- A temporary or permanent setpoint shift for a relative setpoint specification through communication objects is possible.
- Activation of an external fan using an automatic or manual fan control possible.
- Status feedback telegrams (also KNX compliant) can be configured.
- Deactivating the feedback control or the additional level possible using separate 1-bit objects.
- The actual and setpoint temperatures can be output on the KNX if a configurable deviation is detected (also periodically).
- Separate or shared command value output in heating and cooling mode. This produces one or two command value objects for each level.
- Normal or inverted command value output configurable.
- Automatic transmission and cycle time for actuating output configurable.
- Command value limit possible.
- Clipping mode (response of the controller to command values = 100 %) can be set.
- Floor temperature limit possible in heating mode. Thus temperature-controlled switch-off of a floor heater as protective function.
- Setpoint temperature limit possible in cooling mode. If necessary, the controller limits the setpoint temperature to specific values and prevents an adjustment beyond statutory limits.

Temperature limiting value functionality (only for application program version "1.2")

- Temperature value can be monitored.
- Limiting value function can be configured.
- Data format of the limiting value object (1 bit or 1 byte) can be selected.
- Switch-on and switch-off delay times can be defined.
- Limiting value object can be transmitted during change or cyclically.

LED functions

- Display for fault message, if self-adjustment failed.
- Display of Programming mode.

4.2.2 Notes on software

ETS project design and commissioning

For project design and commissioning of this device, we recommend using the ETS5. Project designing and commissioning of the device using ETS4 of version 4.2 is also possible.

Unloading the application program

The application program can be unloaded with the ETS. In this case the device is without function.

4.2.2.1 Device generations and using the application programs

There are different device generations and application programs available. Version 1.2 of the application program has an extended range of functions compared to version 1.1. It is possible to distinguish between the application programs and device generations by means of the version designation.

The designation of the device generation is attached on the device label.

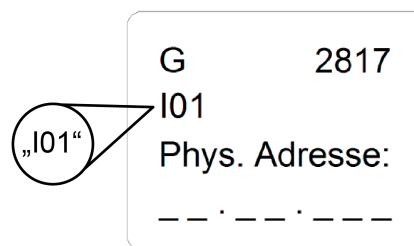

Figure 9: Position of the designation of the device generation on the device label

4.2.2.2 Firmware upgrade

Version of the Application program	Devices up to device generation I00 or higher	Devices with the device generation I01 or higher
1.1	Programming is possible	Programming is possible (Firmware downgrade)
1.2	Programming is possible (Firmware upgrade)	Programming is possible

Downloading capability of application programs

The firmware of the device can be updated independently of the device generation when the device is programmed with a more recent application than version 1.1. The automatic upgrade can eliminate errors contained in the firmware, without the customer having to pay any additional costs. As soon as new firmware for the device is available, it is written to the commissioned device during a download of the application program. The current firmware version is shown in the name of the product database.

The firmware update may take some time. During this period, the device does not send any valid values to the KNX.

After the firmware has been brought up to date, the designed functions are executed in the manner prior to the update.

- i Application programs with an older firmware (e.g. version 1.1) can also be programmed in devices in which the current firmware (e.g. version 1.2) is already embedded. In this case, the scope of functions of the device is reduced by the extensions of version 1.2 of the application program. This downgrade of the firmware also takes some time.

4.2.3 Object table

Number of communication objects:	70 (max. object number 84 - gaps in between)
Number of addresses (max.):	200
Number of assignments (max.):	200

4.2.3.1 Objects for the valve drive

Function: Valve drive					
Object	Function	Name	Type	DPT	Flag
 1	Input	V.Command value	1 bytes	5,001	C, -, W, -, - 1
Description	1-byte input object for the presetting of a constant command value, e.g. of a KNX room temperature controller (0...100 %). Only for application program version "1.2": This object is only available if the parameter "Valve drive control via" is configured in the ETS to "Object" and the command value data format to "8-bit value". Only for application program version "1.1": This object is only available if the command value data format "8-bit value" is configured in the ETS. Received command values are converted by the valve drive through infinite adjustment of the plunger. The precondition is that the received percentage value is within the designed limit and no forced position is active.				

Function: Valve drive					
Object	Function	Name	Type	DPT	Flag
 1	Input	V.Command value	1-bit	1,001	C, -, W, -, - 1
Description	1-bit input object for the presetting of a switching command value, e.g. of a KNX room temperature controller. Only for application program version "1.2": This object is only available if the parameter "Valve drive control via" is configured in the ETS to "Object" and the command value data format to "1-bit switching function". Only for application program version "1.1": This object is only available if the command value data format "1-bit switching function" is configured in the ETS. In this case, the telegram polarity is fixed: "0" = Close valve, "1" = Open valve. This object is only available for valve outputs configured in the ETS to the command value data format "Switching (1-bit)". A received command value telegram ("1" or "0") is converted by the valve drive through infinite adjustment to the command value designed for the object value in the parameters.				

Function: Valve drive					
Object	Function	Name	Type	DPT	Flag
 2	Output	V.Actual position	1 bytes	5,001	C, R, -, T, - ¹
Description	1-byte output object to feed back the active constant command value of the valve drive (0...100 %). The object transmits the current status after each adjustment.				

1: For reading, the R-flag must be set. The last value written to the object via the KNX or by the device will be read out.

Function: Valve drive

Object	Function	Name	Type	DPT	Flag
 ³	Input	V.Valve rinsing start	1-bit	1,001	C, -, W, -, - ₁

Description 1-bit input object for starting and stopping valve rinsing. Valve rinsing can be activated by time or an event using this object. The telegram polarity can be configured. Stopping can be prevented via the object as an option. The time of cyclical valve rinsing is restarted as soon as an externally started valve rinsing operation is stopped by a Stop telegram or by the expiry of the rinsing time. Updates of the object from "Start" to "Start" or "Stop" to "Stop" do not produce a reaction. The length of an elapsing valve rinsing operation or the cycle time of the cyclical valve rinsing are not restarted by this.

Function: Valve drive

Object	Function	Name	Type	DPT	Flag
 ⁴	Output	V.Valve rinsing status	1-bit	1,001	C, R, -, T, - ¹

Description 1-bit output object for status feedback of a valve rinsing operation. The telegram polarity is fixed: "0" = Valve rinsing inactive, "1" = Valve rinsing active. The object transmits the current status after bus and mains voltage return and after an ETS programming operation without a delay.

Function: Valve drive

Object	Function	Name	Type	DPT	Flag
 ⁵	Input	V.Forced position 1	1-bit	1,001	C, -, W, -, - ₁





Description 1-bit input object for activating and deactivating the forced position 1. The telegram polarity can be configured. Updates of the object from "Forced position active" to "Forced position active" or from "Forced position inactive" to "Forced position inactive" produce no reaction.

Function: Valve drive

Object	Function	Name	Type	DPT	Flag
 ⁶	Input	V.Forced position 2	1-bit	1,001	C, -, W, -, - ₁

Description 1-bit input object for activating and deactivating the forced position 2. The telegram polarity can be configured. Updates of the object from "Forced position active" to "Forced position active" or from "Forced position inactive" to "Forced position inactive" produce no reaction.

1: For reading, the R-flag must be set. The last value written to the object via the KNX or by the device will be read out.

Function:	Valve drive				
Object	Function	Name	Type	DPT	Flag
 ⁷	Input	V.min. Limit	1-bit	1,001	C, -, W, -, - ₁
Description	1-bit input object for requirement-orientated activating and deactivating of a minimum command value limit, which can be designed. The telegram polarity can be configured. Updates of the object from "1" to "1" or "0" to "0" do not produce a reaction. It is possible to have the actuator activate the command value limit automatically after bus voltage return or an ETS programming operation. The status of the command value limit is not then automatically tracked in the communication object.				
Function:	Valve drive				
Object	Function	Name	Type	DPT	Flag
 ⁸	Input	V.Max. Limit	1-bit	1,001	C, -, W, -, - ₁
Description	1-bit input object for requirement-orientated activating and deactivating of a maximum command value limit, which can be designed. The telegram polarity can be configured. Updates of the object from "1" to "1" or "0" to "0" do not produce a reaction. It is possible to have the actuator activate the command value limit automatically after bus voltage return or an ETS programming operation. The status of the command value limit is not then automatically tracked in the communication object.				
Function:	Valve drive				
Object	Function	Name	Type	DPT	Flag
 ⁹	Output	V.Limiting value	1-bit	1,001	C, R, -, T, - ¹
Description	1-bit output object for the transmission of an exceeded limiting value or a limiting value undershoot. The type of limiting value message and the limiting value are defined in the parameters.				
Function:	Valve drive				
Object	Function	Name	Type	DPT	Flag
 ¹⁰	Input	V.Day / night	1-bit	1,001	C, -, W, -, - ₁
Description	This communication object is used to prevent cyclical valve rinsing at night. It is only visible if the time object is not used. A KNX telegram tells the device whether it is day ("1") or night ("0"). If cyclical valve rinsing is to be performed during a night phase, then this is suppressed until this communication object receives a "1" telegram for day. Cyclical valve rinsing is carried out as planned as soon as the device is back in a day phase. This communication object has no effect on a valve rinsing operation started via the object "V.Valve rinsing Start" via a KNX telegram.				

1: For reading, the R-flag must be set. The last value written to the object via the KNX or by the device will be read out.

Function:	Valve drive				
Object	Function	Name	Type	DPT	Flag
 ¹²	Input	V.Time	3 bytes	10,001	C, -, W, -, - 1
Description	<p>This communication object is used to prevent cyclical valve rinsing at night. The valve drive possesses an internal clock. This checks the designed cycle time in weeks in a 24-hour cycle and, if necessary, starts cyclical valve rinsing. If the clock is synchronised, cyclical valve rising begins at 10:00 a.m. at the earliest and at 6:00 p.m. at the latest. The internal clock of the device runs with a small gait deviation, which increases over time. For this reason, the internal clock should be synchronised with the KNX on a regular basis. This communication object has no effect on a valve rinsing operation started via the object "V.Valve rinsing Start" via a KNX telegram. If the time object is not enabled in the parameters, the object "V.Day / Night" is available.</p>				

Function:	Valve drive				
Object	Function	Name	Type	DPT	Flag
 ¹³	Output	V.Fault	1-bit	1,001	C, -, W, T, - 1
Description	<p>The function of the communication object is defined by the "Fault message" parameter:</p> <p>"ON" telegram on adjustment error: Self-adjustment takes place immediately after bus voltage return or after an ETS programming operation. The 1-bit output object signals a failed self-adjustment. The error is always signalled via the flashing Programming/Status LED and, optionally, by this object with a "1" telegram. The error can only be eliminated with a repeated self-adjustment (bus voltage failure and return or ETS programming operation). This acknowledges the fault message in the same way.</p> <p>"ON" telegram on adjustment operation: Self-adjustment takes place immediately after bus voltage return or after an ETS programming operation. The 1-bit output object signals an active self-adjustment. Self-adjustment is optionally signalled by this object with a "1" telegram. After self-adjustment is completed, the status of the communication object changes to "0". The success of the self-adjustment operation is not significant.</p> <p>"ON" telegram on controller timeout: 1-bit output object to signal a faulty command value (with active command value monitoring, no command value telegram was received within the monitoring time). The error is signalled with a "1" telegram. Immediately after the bus voltage return or an ETS programming operation, the object "Command value fault" does not transmit the status automatically. A faulty command value must be detected again (expiry of the monitoring time without a command value telegram) for the object value to be transmitted.</p>				

1: For reading, the R-flag must be set. The last value written to the object via the KNX or by the device will be read out.

4.2.3.2 Objects for the input

Function:		Binary input: Switching function				
Object	Function	Name	Type	DPT	Flag	
 ^{20, 22}	Switching 1.X	I.Input 1	1-bit	1,001	C, -, W, T, - ₁	
Description	1-bit object for transmission of switching telegrams (ON, OFF). (first switching object)					

Function:		Binary input: Dimming function				
Object	Function	Name	Type	DPT	Flag	
 ²⁰	Switching	I.Input 1	1-bit	1,001	C, -, W, T, - ₁	
Description	1-bit object for the transmission of switching telegrams (ON, OFF) for the dimming function.					

Function:		Binary input: Dimming function				
Object	Function	Name	Type	DPT	Flag	
 ²²	Dimming	I.Input 1	4-bit	3,007	C, -, -, T, - ¹	
Description	4-bit object for change of relative brightness between 0 and 100 %.					

Function:		Binary input: Venetian blind function				
Object	Function	Name	Type	DPT	Flag	
 ²⁰	Short time operation	I.Input 1	1-bit	1,007	C, -, -, T, - ¹	
Description	1-bit object for short-time operation of a blind.					

Function:		Binary input: Venetian blind function				
Object	Function	Name	Type	DPT	Flag	
 ²²	Long-time operation	I.Input 1	1-bit	1,008	C, -, W, T, - ₁	
Description	1-bit object for long-time operation of a blind.					

Function:		Binary input: Dimming value transmitter function				
Object	Function	Name	Type	DPT	Flag	
 ²⁰	Value transmitter, 8-bit	I.Input 1	1 byte	5,010	C, -, -, T, - ₁	
Description	1 byte object to transmit value telegrams (0 ... 255).					

1: For reading, the R-flag must be set. The last value written to the object via the KNX or by the device will be read out.

Function: Binary input: Light scene extension without memory function

Object	Function	Name	Type	DPT	Flag
 ²⁰	Scene extension	I.Input 1	1 byte	18,001	C, -, -, T, - ¹

Description 1-byte object for recalling light scenes (1 ... 64).

Function: Binary input: Light scene extension with memory function

Object	Function	Name	Type	DPT	Flag
 ²⁰	Scene extension	I.Input 1	1 byte	18,001	C, -, -, T, - ¹

Description 1-byte object for opening or saving light scenes (1 ... 64).

Function: Binary input: Temperature value transmitter function

Object	Function	Name	Type	DPT	Flag
 ²⁰	Value transmitter 2-byte	I.Input 1	2 byte	9,001	C, -, -, T, - ₁

Description 2-byte object for transmission of temperature value telegrams (0 °C ... 40 °C).

Function: Binary input: Brightness value transmitter function

Object	Function	Name	Type	DPT	Flag
 ²⁰	Value transmitter 2-byte	I.Input 1	2 byte	9,004	C, -, -, T, - ₁

Description 2-byte object for transmission of brightness value telegrams (0 Lux ... 1,500 Lux).

1: For reading, the R-flag must be set. The last value written to the object via the KNX or by the device will be read out.

4.2.3.3 Objects for disabling the input

Function: Disabling the binary input

Object	Function	Name	Type	DPT	Flag
 ²⁴	Disabling	I.Input 1	1-bit	1,001	C, -, W, -, - ₁

Description 1-bit object for disabling the first object of the input (polarity configurable).

Function: Disabling the binary input

Object	Function	Name	Type	DPT	Flag
 ²⁶	Disable object 1.2	I.Input 1	1-bit	1,001	C, -, W, -, - ₁

Description 1-bit object for disabling the second switching object of the input (polarity configurable).
Only for the "Switching" function!

1: For reading, the R-flag must be set. The last value written to the object via the KNX or by the device will be read out.

4.2.3.4 Objects for room temperature measurement

Function: Temperature measurement

Object	Function	Name	Type	DPT	Flag
 ³⁰	Measured value	T.Internal sensor	2 bytes	9,001	C, -, -, T, - ₁

Description 2-byte object for the output of the temperature measured by the internal sensor (calibrated). Possible value range: -99.9 °C to +99.9 °C / Measuring range of internal temperature sensor: 0 °C to +40 °C.
The temperature value is always output in the format "°C".
Only as of application program version "1.2" the objects "T.Internal sensor" are always visible as soon as the room temperature measurement is switched on, independent of the temperature detection of the room temperature measurement.

Function: Temperature measurement

Object	Function	Name	Type	DPT	Flag
 ³¹	Non-balanced measured value	T.Internal sensor	2 bytes	9,001	C, -, -, T, - ₁

Description 2-byte object for the output of the temperature measured by the internal sensor (uncalibrated). Possible value range: -99.9 °C to +99.9 °C / Measuring range of internal temperature sensor: 0 °C to +40 °C.
The temperature value is always output in the format "°C".
Only as of application program version "1.2" the objects "T.Internal sensor" are always visible as soon as the room temperature measurement is switched on, independent of the temperature detection of the room temperature measurement.

Function: Temperature measurement

Object	Function	Name	Type	DPT	Flag
 ³²	Measured value	T.Remote sensor	2 bytes	9,001	C, -, -, T, - ¹

Description 2-byte object for the output of the temperature measured by the remote sensor (uncalibrated). Possible value range: -99.9 °C to +99.9 °C / Measuring range of internal temperature sensor: 0 °C to +40 °C.
The temperature value is always output in the format "°C".
Only as of application program version "1.2" the objects "T.Remote sensor" are always visible as soon as the parameter "Function input" is set to "Remote sensor", independent of the temperature detection of the room temperature measurement.

1: For reading, the R-flag must be set. The last value written to the object via the KNX or by the device will be read out.

Function:	Temperature measurement				
Object	Function	Name	Type	DPT	Flag
 ³³	Non-balanced measured value	T.Remote sensor	2 bytes	9,001	C, -, -, T, - ₁
Description	2-byte object for the output of the temperature measured by the remote sensor (uncalibrated). Possible value range: -99.9 °C to +99.9 °C / Measuring range of internal temperature sensor: 0 °C to +40 °C. The temperature value is always output in the format "°C". Only as of application program version "1.2" the objects "T.Remote sensor" are always visible as soon as the parameter "Function input" is set to "Remote sensor", independent of the temperature detection of the room temperature measurement.				

Function:	Temperature measurement				
Object	Function	Name	Type	DPT	Flag
 ³⁴	Received temperature	T.external temperature	2 bytes	9,001	C, -,W, T, U ₁
Description	2-byte object for receiving a temperature. In addition, an external KNX room temperature sensor can be integrated in the room temperature measurement of the device. Possible range of values: -99.9 °C to +99.9 °C. The temperature value must always be specified in the format "°C".				

Function:	Temperature measurement				
Object	Function	Name	Type	DPT	Flag
 ³⁵	Actual-temperature	T.Temperature measurement	2 bytes	9,001	C, -, -, T, - ₁
Description	2-byte object for the display of the determined actual temperature (room temperature). The parameter "Temperature detection by" defines the type of temperature detection. The output value considers the parameterised value for the calibration as well as the correction through an external temperature sensor connected to the object "External temperature sensor". Possible value range: -99.9 °C to +99.9 °C / Measuring range of internal temperature sensor: 0 °C to +40 °C. The temperature value is always output in the format "°C".				

1: For reading, the R-flag must be set. The last value written to the object via the KNX or by the device will be read out.

4.2.3.5 Objects for the room temperature controller

Function: Room temperature controller: Underfloor heating

Object	Function	Name	Type	DPT	Flag
 ³⁸	Floor temperature	C.Input	2 bytes	9,001	C, -, W, -, - 1

Description: 2-byte object for external specification of the floor temperature for activated underfloor heating temperature limiting. If the received temperature value exceeds the configured maximum underfloor heating temperature, then the temperature limiting will begin to act.
The temperature value must always be specified in the format "°C".

Function: Room temperature controller: Underfloor heating

Object	Function	Name	Type	DPT	Flag
 ³⁸	Floor temperature	C.Output	2 bytes	9,001	C, R, -, T, - ¹

Description: 2-byte object for the output of the floor temperature to the KNX, if the floor temperature is measured via a remote sensor (function input: Temperature limiter, underfloor heating). If the measured temperature value exceeds the configured maximum underfloor heating temperature, then the temperature limitation will begin to act.
The temperature value is always output in the format "°C".

Function: Room temperature controller: Setpoint temperature specification

Object	Function	Name	Type	DPT	Flag
 ⁴⁰	Basic setpoint	C.Input	2 bytes	9,001	C, -, W, -, - 1

Description: 2-byte object for external specification of the basic setpoint for relative setpoint specification. Depending on the operating mode, the possible range of values is limited by the configured frost protection and/or heat protection temperature. The controller rounds the temperature values received via the object depending on the configured interval of the basic setpoint shift (0.1 K, 0.5 K or 1.0 K).
The temperature value must always be specified in the format "°C".

Function: Room temperature controller: Setpoint temperature specification

Object	Function	Name	Type	DPT	Flag
 ⁴⁰	Setpoint active operating mode	C.Input	2 bytes	9,001	C, -, W, -, - 1

Description: 2-byte object for external setting of a setpoint for absolute setpoint presetting. Depending on the operating mode, the possible range of values is limited by the configured frost protection and/or heat protection temperature. The controller rounds the temperature values received via the object to 0.1 K. The temperature value must always be specified in the format "°C".
The setpoint modified by the setpoint shift can be reported back to the KNX via the object by setting the "Transmit" flag.

1: For reading, the R-flag must be set. The last value written to the object via the KNX or by the device will be read out.

Function:	Room temperature controller: Operating mode switch-over				
Object	Function	Name	Type	DPT	Flag
 ⁴²	Operating mode switchover	C.Input	1 bytes	20,102	C, -,W, T, - ₁
Description	1-byte object for change-over of the operating mode of the controller according to the KNX specification. This object is only available in this way when the operating mode switch-over is to take place via 1 byte (parameter-dependent).				

Function:	Room temperature controller: Operating mode switch-over				
Object	Function	Name	Type	DPT	Flag
 ⁴²	Comfort mode	C.Input	1-bit	1,001	C, -,W, T, - ₁
Description	1-bit object for change-over to the "Comfort" operating mode. This object is only available in this way when the operating mode switch-over is to take place over 4 x 1 bit (parameter-dependent).				

Function:	Room temperature controller: Operating mode switch-over				
Object	Function	Name	Type	DPT	Flag
 ⁴³	Standby mode	C.Input	1-bit	1,001	C, -,W, T, - ₁
Description	1-bit object for change-over to the "Standby" operating mode. This object is only available in this way when the operating mode switch-over is to take place over 4 x 1 bit (parameter-dependent).				

Function:	Room temperature controller: Operating mode switch-over				
Object	Function	Name	Type	DPT	Flag
 ⁴⁴	Night operation	C.Input	1-bit	1,001	C, -,W, T, - ₁
Description	1-bit object for change-over to the "Night" operating mode. This object is only available in this way when the operating mode switch-over is to take place over 4 x 1 bit (parameter-dependent).				

Function:	Room temperature controller: Operating mode switch-over				
Object	Function	Name	Type	DPT	Flag
 ⁴⁵	Frost/ heat protection	C.Input	1-bit	1,001	C, -,W, T, - ₁
Description	1-bit object for change-over to the "Frost / heat protection" operating mode. This object is only available in this way when the operating mode switch-over is to take place over 4 x 1 bit (parameter-dependent).				

1: For reading, the R-flag must be set. The last value written to the object via the KNX or by the device will be read out.

Function:	Room temperature controller: Operating mode switch-over				
Object	Function	Name	Type	DPT	Flag
 ⁴⁶	Operating mode forced-control	C.Input	1 bytes	20,102	C, -, W, T, - 1
Description	1-byte object for forced change-over (highest priority) of the operating mode of the controller according to the KNX specification. This object is only available in this way when the operating mode switch-over is to take place via 1 byte (parameter-dependent).				

Function:	Room temperature controller: Operating mode switch-over, presence detection				
Object	Function	Name	Type	DPT	Flag
 ⁴⁷	Presence object	C.Input / Output	1-bit	1,001	C, -, W, T, - 1
Description	1-bit object through which a presence detector or an external presence button (e.g. from a controller extension) can be linked to the controller. The object can optionally be read (set "Read" flag), meaning that an internally changed presence status (e.g. through operating a button on the controller) can also be evaluated in other KNX devices. No telegram is sent automatically in the case of an internal change in the presence status! Polarity: presence detected = "1", presence not detected = "0".				

Function:	Room temperature controller: Operating mode switch-over window status				
Object	Function	Name	Type	DPT	Flag
 ⁴⁸	Window status	C.Input	1-bit	1,019	C, -, W, -, - 1
Description	1-bit object for the coupling of window contacts. Polarity: Window open = "1", window closed = "0".				

Function:	Room temperature controller: Operating mode change-over				
Object	Function	Name	Type	DPT	Flag
 ⁴⁹	Heating / cooling change-over	C.Output	1-bit	1,100	C, -, -, T, U 1
Description	1 bit object to transmit the automatically set operating mode of the controller ("Heating" or "Cooling" modes). Object value "1" = Heating; Object value "0" = Cooling. This object is only available in this way when the operating mode change-over is to take place automatically (parameter-dependent).				

Function:	Room temperature controller: Operating mode change-over				
Object	Function	Name	Type	DPT	Flag
 ⁴⁹	Heating / cooling change-over	C.Input / Output	1-bit	1,100	C, -, -, T, U 1
Description	1 bit object to change-over the operating mode of the controller ("Heating" or "Cooling" modes). Object value "1" = Heating; Object value "0" = Cooling. This object is only available in this way when the operating mode change-over is to take place manually (not automatically by the controller) (parameter-dependent).				

1: For reading, the R-flag must be set. The last value written to the object via the KNX or by the device will be read out.

Function: Room temperature controller: Status message

Object	Function	Name	Type	DPT	Flag
 50	KNX status operating mode	C.Output	1 bytes	20,102	C, -, -, T, - 1

Description 1-byte object used by the controller to output the current operating mode. This object is usually used to enable controller extensions to display the controller operating mode correctly in the KNX-compliant status display. Therefore this object should be connected with controller extensions if the KNX compliant status feedback is not configured. Only when "Controller status" = "KNX compliant".

Function: Room temperatur control

Object	Function	Name	Type	DPT	Flag
 50	Controller status	C.Output	1 bytes	---	C, -, -, T, - ¹

Description 1-byte object used by the controller to output the current state of operation (e.g. to a controller extension). Only when "Controller status" = "Controller general".

Function: Room temperature control: Status message

Object	Function	Name	Type	DPT	Flag
 50	Controller status, Comfort mode	C.Output	1-bit	1,001	C, -, -, T, - 1

Description 1-bit object for single status feedback of configured controller functions. This object is only available in this way when a part of the controller status is to be transmitted singly as 1-bit information (parameter-dependent).

Function: Room temperature control: Status message

Object	Function	Name	Type	DPT	Flag
 50	Controller status, Standby mode	C.Output	1-bit	1,001	C, -, -, T, - 1

Description 1-bit object for single status feedback of configured controller functions. This object is only available in this way when a part of the controller status is to be transmitted singly as 1-bit information (parameter-dependent).

Function: Room temperature control: Status message

Object	Function	Name	Type	DPT	Flag
 50	Controller status, night mode	C.Output	1-bit	1,001	C, -, -, T, - 1

Description 1-bit object for single status feedback of configured controller functions. This object is only available in this way when a part of the controller status is to be transmitted singly as 1-bit information (parameter-dependent).

1: For reading, the R-flag must be set. The last value written to the object via the KNX or by the device will be read out.

Function:	Room temperature control: Status message				
Object	Function	Name	Type	DPT	Flag
 ⁵⁰	Contr.status, frost/heat prot.	C.Output	1-bit	1,001	C ₁ , -, -, T, -
Description	1-bit object for single status feedback of configured controller functions. This object is only available in this way when a part of the controller status is to be transmitted singly as 1-bit information (parameter-dependent).				

Function:	Room temperature control: Status message				
Object	Function	Name	Type	DPT	Flag
 ⁵⁰	Controller status, contr. disabled	C.Output	1-bit	1,001	C ₁ , -, -, T, -
Description	1-bit object for single status feedback of configured controller functions. This object is only available in this way when a part of the controller status is to be transmitted singly as 1-bit information (parameter-dependent).				

Function:	Room temperature control: Status message				
Object	Function	Name	Type	DPT	Flag
 ⁵⁰	Contr. status, heating/cooling	C.Output	1-bit	1,001	C ₁ , -, -, T, -
Description	1-bit object for single status feedback of configured controller functions. This object is only available in this way when a part of the controller status is to be transmitted singly as 1-bit information (parameter-dependent).				

Function:	Room temperature control: Status message				
Object	Function	Name	Type	DPT	Flag
 ⁵⁰	Controller status contr. inactive	C.Output	1-bit	1,001	C ₁ , -, -, T, -
Description	1-bit object for single status feedback of configured controller functions. This object is only available in this way when a part of the controller status is to be transmitted singly as 1-bit information (parameter-dependent).				

Function:	Room temperature control: Status message				
Object	Function	Name	Type	DPT	Flag
 ⁵⁰	Controller status, frost alarm	C.Output	1-bit	1,001	C ₁ , -, -, T, -
Description	1-bit object for single status feedback of configured controller functions. This object is only available in this way when a part of the controller status is to be transmitted singly as 1-bit information (parameter-dependent).				

Function:	Room temperature control: Heating energy message				
Object	Function	Name	Type	DPT	Flag
 ⁵¹	Heating indication	C.Output	1-bit	1,001	C ₁ , -, -, T, -
Description	1-bit object for the controller to report a request for heating energy. Object value = "1": energy request, object value = "0": no energy request.				

1: For reading, the R-flag must be set. The last value written to the object via the KNX or by the device will be read out.

Function:	Room temperature control: Cooling energy message				
Object	Function	Name	Type	DPT	Flag
 ⁵²	Cooling indication	C.Output	1-bit	1,001	C, -, -, T, - 1
Description	1-bit object for the controller to report a request for cooling energy. Object value = "1": energy request, object value = "0": no energy request.				

Objects for controller disabling functions





Function:	Room temperature control: Disable controller				
Object	Function	Name	Type	DPT	Flag
 ⁵⁴	Disable controller	C.Input	1-bit	1,001	C, -, W, T, U 1
Description	1-bit object for deactivating the controller (activating dew point operation). Polarity: Controller deactivated = "1", controller activated = "0".				

Function:	Room temperature control: Disable controller				
Object	Function	Name	Type	DPT	Flag
 ⁵⁵	Disable additional level	C.Input	1-bit	1,001	C, -, W, -, - 1
Description	1-bit object for deactivating the additional level of the controller. Polarity: Additional level deactivated = "1", additional level activated = "0". This object is only available in this way if two-level heating or cooling operation is configured.				

Function:	Room temperatur control: Command value				
Object	Function	Name	Type	DPT	Flag
 ⁵⁶	Command value for heating / command value, basic heating	C.Output	1 bytes	5,001	C, -, -, T, - ¹
Description	1-byte object to output the continuous command value of the heating mode. In two-level heating mode, command value output for the basic heating. This object is only available in this way if the type of feedback control is configured to "Continuous PI control".				

Function:	Room temperatur control: Command value				
Object	Function	Name	Type	DPT	Flag
 ⁵⁶	Command value for heating (PWM) / command value, basic heating (PWM)	C.Output	1-bit	1,001	C, -, -, T, - 1
Description	1-bit object to output the PWM command value of the heating mode. In two-level heating mode, command value output for the basic heating. This object is only available in this way if the type of feedback control is configured to "Switching PI control (PWM)".				

1: For reading, the R-flag must be set. The last value written to the object via the KNX or by the device will be read out.

Function:	Room temperatur control: Command value				
Object	Function	Name	Type	DPT	Flag
 ⁵⁶	Command value for heating / command value, basic heating	C.Output	1-bit	1,001	C, -, -, T, - ¹
Description	1-bit object to output the switching command value of the heating mode. In two-level heating mode, command value output for the basic heating. This object is only available in this way if the type of feedback control is configured to "Switching 2-point feedback control".				
Function:	Room temperatur control: Command value				
Object	Function	Name	Type	DPT	Flag
 ⁵⁶	Command value for heating/cooling / command value, basic level	C.Output	1 bytes	5,001	C, -, -, T, - ¹
Description	1-byte object to output the combined continuous command value of the heating and cooling mode. In two-level heating/cooling mode, command value output for the basic level This object is only available in this way if the command values for heating and cooling mode are output to a shared object (parameter-dependent). The type of feedback control must also be configured to "Continuous PI control".				
Function:	Room temperatur control: Command value				
Object	Function	Name	Type	DPT	Flag
 ⁵⁶	Command value for heating/cooling (PWM) / command value, basic level (PWM)	C.Output	1-bit	1,001	C, -, -, T, - ¹
Description	1-bit object to output the combined PWM command value of the heating and cooling mode. In two-level heating/cooling mode, command value output for the basic level This object is only available in this way if the command values for heating and cooling mode are output to a shared object (parameter-dependent). The type of feedback control must also be configured to "Switching PI control (PWM)".				
Function:	Room temperatur control: Command value				
Object	Function	Name	Type	DPT	Flag
 ⁵⁶	Command value for heating/cooling / command value, basic level	C.Output	1-bit	1,001	C, -, -, T, - ¹
Description	1-bit object to output the combined switching command value of the heating and cooling mode. In two-level heating/cooling mode, command value output for the basic level This object is only available in this way if the command values for heating and cooling mode are output to a shared object (parameter-dependent). The type of feedback control must also be configured to "Switching 2-point feedback control".				

1: For reading, the R-flag must be set. The last value written to the object via the KNX or by the device will be read out.

Object for command value output, additional heating and combined valve additional heating/cooling

Function: Room temperatur control: Command value

Object	Function	Name	Type	DPT	Flag
 57	Cmd. value, additional heating	C.Output	1 bytes	5,001	C, -, -, T, - ¹

Description 1-byte object to output the continuous command value for additional heating in two-level operation. This object is only available in this way if the type of feedback control is configured to "Continuous PI control".

Function: Room temperatur control: Command value

Object	Function	Name	Type	DPT	Flag
 57	Cmd. value, add. heating (PWM)	C.Output	1-bit	1,001	C, -, -, T, - ₁

Description 1-bit object to output the continuous PWM command value for additional heating in two-level operation. This object is only available in this way if the type of feedback control is configured to "Switching PI control (PWM)".

Function: Room temperatur control: Command value

Object	Function	Name	Type	DPT	Flag
 57	Cmd. value, additional heating	C.Output	1-bit	1,001	C, -, -, T, - ₁

Description 1-byte object to output the switching command value for additional heating in two-level operation. This object is only available in this way if the type of feedback control is configured to "Switching 2-point feedback control".

Function: Room temperatur control: Command value

Object	Function	Name	Type	DPT	Flag
 57	Command value additional level	C.Output	1 bytes	5,001	C, -, -, T, - ¹

Description 1-byte object to output the combined continuous command value for additional level in two-level operation. This object is only available in this way if the command values for heating and cooling mode are output to a shared object (parameter-dependent). The type of feedback control must also be configured to "Continuous PI control".

Function: Room temperatur control: Command value

Object	Function	Name	Type	DPT	Flag
 57	Command value additional level (PWM)	C.Output	1-bit	1,001	C, -, -, T, - ₁

Description 1-bit object to output the combined switching PWM command value for additional level in two-level operation. This object is only available in this way if the command values for heating and cooling mode are output to a shared object (parameter-dependent). The type of feedback control must also be configured to "Switching PI control (PWM)".

1: For reading, the R-flag must be set. The last value written to the object via the KNX or by the device will be read out.

Function:	Room temperatur control: Command value				
Object	Function	Name	Type	DPT	Flag
 ⁵⁷	Command value additional level	C.Output	1-bit	1,001	C, -, -, T, - ₁
Description	1-bit object to output the combined switching command value for additional level in two-level operation. This object is only available in this way if the command values for heating and cooling mode are output to a shared object (parameter-dependent). The type of feedback control must also be configured to "Switching 2-point feedback control".				

Function:	Room temperatur control: Command value				
Object	Function	Name	Type	DPT	Flag
 ⁵⁸	Command value for cooling / command value, basic cooling	C.Output	1 bytes	5,001	C, -, -, T, - ¹
Description	1-byte object to output the continuous command value of the cooling mode. In two-level cooling mode, command value output for the basic cooling. This object is only available in this way if the type of feedback control is configured to "Continuous PI control".				

Function:	Room temperatur control: Command value				
Object	Function	Name	Type	DPT	Flag
 ⁵⁸	Command value for cooling (PWM) / command value, basic cooling (PWM)	C.Output	1-bit	1,001	C, -, -, T, - ₁
Description	1-bit object to output the PWM command value of the cooling mode. In two-level cooling mode, command value output for the basic cooling. This object is only available in this way if the type of feedback control is configured to "Switching PI control (PWM)".				

Function:	Room temperatur control: Command value				
Object	Function	Name	Type	DPT	Flag
 ⁵⁸	Command value for cooling / command value, basic cooling	C.Output	1-bit	1,001	C, -, -, T, - ¹
Description	1-bit object to output the switching command value of the cooling mode. In two-level cooling mode, command value output for the basic cooling. This object is only available in this way if the type of feedback control is configured to "Switching 2-point feedback control".				

1: For reading, the R-flag must be set. The last value written to the object via the KNX or by the device will be read out.

Object for command value output, additional cooling

Function: Room temperatur control: Command value

Object	Function	Name	Type	DPT	Flag
 ⁵⁹	Cmd. value, additional cooling	C.Output	1 bytes	5,001	C, -, -, T, - ¹

Description 1-byte object to output the continuous command value for additional cooling in two-level operation. This object is only available in this way if the type of feedback control is configured to "Continuous PI control".

Function: Room temperatur control: Command value

Object	Function	Name	Type	DPT	Flag
 ⁵⁹	Cmd. value, add. cooling (PWM)	C.Output	1-bit	1,001	C, -, -, T, - ₁

Description 1-bit object to output the continuous PWM command value for additional cooling in two-level operation. This object is only available in this way if the type of feedback control is configured to "Switching PI control (PWM)".

Function: Room temperatur control: Command value

Object	Function	Name	Type	DPT	Flag
 ⁵⁹	Cmd. value, additional cooling	C.Output	1-bit	1,001	C, -, -, T, - ₁

Description 1-byte object to output the switching command value for additional cooling in two-level operation. This object is only available in this way if the type of feedback control is configured to "Switching 2-point feedback control".

Function: Room temperatur control: Command value

Object	Function	Name	Type	DPT	Flag
 ⁶⁰	PWM command value for heating / PWM command value, basic heating	C.Output	1 bytes	5,001	C, -, -, T, - ¹

Description 1-byte object to output the internal continuous command value of a PWM controller of the heating mode. In two-level heating mode, command value output for the basic heating. This object is only available in this way if the type of feedback control is configured to "Switching PI control (PWM)". In addition to the switching 1 bit command value of the PWM, the calculated continuous command value of the controller can also be transmitted to the bus and displayed, e.g. in a visualisation.

1: For reading, the R-flag must be set. The last value written to the object via the KNX or by the device will be read out.

Function:	Room temperatur control: Command value				
Object	Function	Name	Type	DPT	Flag
 ⁶⁰	PWM command value for heating/cooling / PWM command value, basic level	C.Output	1 bytes	5,001	C, -, -, T, - ¹
Description	1-byte object to output the combined continuous command value of a PWM controller of the heating and cooling mode. In two-level heating/cooling mode, command value output for the basic level This object is only available in this way if the command values for heating and cooling mode are output to a shared object (parameter-dependent). The type of feedback control must also be configured to "Switching PI control (PWM)". In addition to the switching 1 bit command value of the PWM, the calculated continuous command value of the controller can also be transmitted to the bus and displayed, e.g. in a visualisation.				

Function:	Room temperatur control: Command value				
Object	Function	Name	Type	DPT	Flag
 ⁶¹	PWM cmd. value, add. heating	C.Output	1 bytes	5,001	C, -, -, T, - ¹
Description	1-byte object to output the internal continuous command value of a PWM controller for additional heating in two-level operation. This object is only available in this way if the type of feedback control is configured to "Continuous PI control". In addition to the switching 1 bit command value of the PWM, the calculated continuous command value of the controller can also be transmitted to the bus and displayed, e.g. in a visualisation.				

Function:	Room temperatur control: Command value				
Object	Function	Name	Type	DPT	Flag
 ⁶¹	PWM command value additional level	C.Output	1 bytes	5,001	C, -, -, T, - ¹
Description	1-byte object to output the combined continuous command value of a PWM feedback controller for additional level in two-level operation. This object is only available in this way if the command values for heating and cooling mode are output to a shared object (parameter-dependent). The type of feedback control must also be configured to "Switching PI control (PWM)". In addition to the switching 1 bit command value of the PWM, the calculated continuous command value of the controller can also be transmitted to the bus and displayed, e.g. in a visualisation.				

1: For reading, the R-flag must be set. The last value written to the object via the KNX or by the device will be read out.

Object for additional command value output, PWM cooling

Function: Room temperatur control: Command value

Object	Function	Name	Type	DPT	Flag
 ⁶²	PWM command value for cooling / PWM command value, basic cooling	C.Output	1 bytes	5,001	C, -, -, T, - ¹

Description 1-byte object to output the internal continuous command value of a PWM feedback controller of the cooling mode. In two-level cooling mode, command value output for the basic cooling. This object is only available in this way if the type of feedback control is configured to "Switching PI control (PWM)". In addition to the switching 1 bit command value of the PWM, the calculated continuous command value of the controller can also be transmitted to the bus and displayed, e.g. in a visualisation.

Object for additional command value output, PWM additional cooling

Function: Room temperatur control: Command value

Object	Function	Name	Type	DPT	Flag
 ⁶³	PWM cmd. value, add. cooling	C.Output	1 bytes	5,001	C, -, -, T, - ¹

Description 1-byte object to output the internal continuous command value of a PWM feedback controller for additional cooling in two-level operation. This object is only available in this way if the type of feedback control is configured to "Switching PI control (PWM)". In addition to the switching 1 bit command value of the PWM, the calculated continuous command value of the controller can also be transmitted to the bus and displayed, e.g. in a visualisation.

Function: Room temperature control: Setpoint temperature

Object	Function	Name	Type	DPT	Flag
 ⁶⁴	Set temperature	C.Output	2 bytes	9,001	C, R, -, T, - ¹

Description 2-byte object for the output of the current temperature setpoint. Depending on the operating mode, the possible range of values is limited by the configured frost protection and/or heat protection temperature. The temperature value is always output in the format "°C".

1: For reading, the R-flag must be set. The last value written to the object via the KNX or by the device will be read out.

Function:	Room temperature control: Status message				
Object	Function	Name	Type	DPT	Flag
 ⁶⁵	KNX status	C.Output	2 bytes	22,101	C, -, -, T, - ¹
Description	2-byte object that the controller uses to display elementary basic functions in a KNX-harmonised manner. Only when "Controller status" = "KNX compliant".				

Function:	Room temperature control: Basic setpoint shifting				
Object	Function	Name	Type	DPT	Flag
 ⁶⁶	Current setpoint shifting	C.Output	1 bytes	6,010	C, R, -, T, - ¹
Description	1-byte object for giving feedback on the current setpoint shifting. The step width of the setpoint shift is defined by the parameter of the same name (0.1 K, 0.5 K or 1.0 K). The value "0" means that no shift is active . The value is depicted in a double complement in the positive and negative direction. This object is only available in this way if relative setpoint presetting is configured.				

Function:	Room temperature control: Basic setpoint shifting				
Object	Function	Name	Type	DPT	Flag
 ⁶⁷	Preset setpoint shifting	C.Input	1 bytes	6,010	C, -, W, -, - ₁
Description	1-byte object for setting a basic setpoint shifting, e.g. via a controller extension. The step width of the setpoint shift is defined by the parameter of the same name (0.1 K, 0.5 K or 1.0 K). The value "0" means that no shift is active . The value is depicted in a double complement in the positive and negative direction. In case the limits of the value range are exceeded by the preset external value, the controller will automatically reset the received value to the minimum and maximum limits. This object is only available in this way if relative setpoint presetting is configured.				

Function:	Room temperature control: Status message				
Object	Function	Name	Type	DPT	Flag
 ⁶⁸	Status signal addition	C.Output	1 bytes	---	C, R, -, T, - ¹
Description	1-byte object used by the controller to output the current enlarged state of operation (e.g. to a controller extension). Only when "Controller status" = "Controller general".				

1: For reading, the R-flag must be set. The last value written to the object via the KNX or by the device will be read out.

 Function: Room temperature control: Status message

Object	Function	Name	Type	DPT	Flag
 ⁶⁹	KNX status forced operating mode	C.Output	1 bytes	20,102	C, -, -, T, - ¹

Description 1-byte object used by the controller to output the operating mode in the event of forced position. This object is usually used to enable controller extensions to display the controller operating mode correctly in the KNX-compliant status display. Therefore this object should be connected with controller extensions if the KNX compliant status feedback is not configured.
Only when "Controller status" = "KNX compliant".

Object for command value limit

 Function: Room temperature control: Command value limit

Object	Function	Name	Type	DPT	Flag
 ⁷⁰	Command value limit	C.Input	1-bit	1,001	C, -, W, -, - ₁

Description 1-bit object for activating or deactivating the command value limit.

Objects for fan control

 Function: Room temperature control: Fan controller

Object	Function	Name	Type	DPT	Flag
 ⁷²	Ventilation, automatic/manual	C.Input	1-bit	1,001	C, -, W, T, - ₁

Description 1-bit object to change-over the operating mode of the fan controller (configurable polarity).

 Function: Room temperature control: Fan controller

Object	Function	Name	Type	DPT	Flag
 ⁷³	Ventilation, fan level 1-8	C.Output	1-bit	5,010	C, R, -, T, - ₁

Description 1-byte object for value-guided activation of the fan levels. This object is only available in this way when the fan control is to take place over 1 byte (parameter-dependent).

 Function: Room temperature control: Fan controller

Object	Function	Name	Type	DPT	Flag
 ⁷³	Ventilation, fan level 1	C.Output	1-bit	1,001	C, R, -, T, - ¹

Description 1-bit object for switching activation of the first fan level. This object is only available in this way when the fan control is to take place over 3 x 1 bit and at least one fan level is enabled (parameter-dependent).

1: For reading, the R-flag must be set. The last value written to the object via the KNX or by the device will be read out.

Function: Room temperature control: Fan controller

Object	Function	Name	Type	DPT	Flag
 ⁷⁴	Ventilation, fan level 2	C.Output	1-bit	1,001	C, R, -,T, - ¹

Description 1-bit object for switching activation of the second fan level. This object is only available when the fan control is to take place over 3 x 1 bit and at least two fan levels are enabled (parameter-dependent).

Function: Room temperature control: Fan controller

Object	Function	Name	Type	DPT	Flag
 ⁷⁵	Ventilation, fan level 3	C.Output	1-bit	1,001	C, R, -,T, - ¹

Description 1-bit object for switching activation of the third fan level. This object is only available when the fan control is to take place over 3 x 1 bit and at least three fan levels are enabled (parameter-dependent).

Function: Room temperature control: Fan controller

Object	Function	Name	Type	DPT	Flag
 ⁷⁶	Ventilation, fan level 4	C.Output	1-bit	1,001	C, R, -,T, - ¹

Description 1-bit object for switching activation of the fourth fan level. This object is only available when the fan control is to take place over 3 x 1 bit and at least four fan levels are enabled (parameter-dependent).

Function: Room temperature control: Fan controller

Object	Function	Name	Type	DPT	Flag
 ⁷⁷	Ventilation, fan level 5	C.Output	1-bit	1,001	C, R, -,T, - ¹

Description 1-bit object for switching activation of the fifth fan level. This object is only available when the fan control is to take place over 3 x 1 bit and at least five fan levels are enabled (parameter-dependent).

Function: Room temperature control: Fan controller

Object	Function	Name	Type	DPT	Flag
 ⁷⁸	Ventilation, fan level 6	C.Output	1-bit	1,001	C, R, -,T, - ¹

Description 1-bit object for switching activation of the sixth fan level. This object is only available when the fan control is to take place over 3 x 1 bit and at least six fan levels are enabled (parameter-dependent).

Function: Room temperature control: Fan controller

Object	Function	Name	Type	DPT	Flag
 ⁷⁹	Ventilation, fan level 7	C.Output	1-bit	1,001	C, R, -,T, - ¹

Description 1-bit object for switching activation of the seventh fan level. This object is only available when the fan control is to take place over 3 x 1 bit and at least seven fan levels are enabled (parameter-dependent).

1: For reading, the R-flag must be set. The last value written to the object via the KNX or by the device will be read out.

Function:	Room temperature control: Fan controller				
Object	Function	Name	Type	DPT	Flag
 ⁸⁰	Ventilation, fan level 8	C.Output	1-bit	1,001	C, R, -, T, - ¹
Description	1-bit object for switching activation of the eighth fan level. This object is only available when the fan control is to take place over 3 x 1 bit and at least eight fan levels are enabled (parameter-dependent).				

Function:	Room temperature control: Fan controller				
Object	Function	Name	Type	DPT	Flag
 ⁸¹	Ventilation, forced position	C.Input	1-bit	1,001	C, -, W, -, - ₁
Description	1-bit object for activation of the fan forced position. Polarity: Forced position ON = "1"; Forced position OFF = "0".				

Function:	Room temperature control: Fan controller				
Object	Function	Name	Type	DPT	Flag
 ⁸²	Ventilation, level limit	C.Input	1-bit	1,001	C, -, W, -, - ₁
Description	1-bit object for activation of the fan level limitation. Polarity: Fan level limitation ON = "1"; Fan level limitation OFF = "0".				

Function:	Room temperature control: Fan controller				
Object	Function	Name	Type	DPT	Flag
 ⁸³	Ventilation, fan protection	C.Input	1-bit	1,001	C, -, W, -, - ₁
Description	1-bit object for activating the fan protection. Polarity: Fan protection ON = "1" / Fan protection OFF = "0".				

Function:	Room temperature control: Fan controller				
Object	Function	Name	Type	DPT	Flag
 ⁸⁴	Ventilation visualisation	C.Output	1 bytes	5,010	C, R, -, T, - ¹
Description	1-byte object for additional value-guided acknowledgement of the active fan level. Value meaning: "0" = Fan OFF, "1" = level 1 active, "2" = level 2 active, ..., "8" = level 8 active.				

1: For reading, the R-flag must be set. The last value written to the object via the KNX or by the device will be read out.

4.2.3.6 Objects for the temperature limiting value

Function: Temperature limiting value

Object	Function	Name	Type	DPT	Flag
 ⁸⁵	Temperature limiting value	G.Output	1-bit	1,001	C, R, -, T, -

Description The temperature limiting value defined in the parameters must be exceeded or undershot so that this communication object can optionally transmit a telegram to the KNX. The parameter "Limiting value function" defines whether the KNX telegram is transmitted when the value is exceeded or undershot. The data format of the communication object "G.Output temperature limiting value" can be defined as a 1-bit object or as a 1-byte object. The 1-bit limiting value object sends a "1" or a "0" to the KNX according to the defined thresholds.

Function: Temperature limiting value

Object	Function	Name	Type	DPT	Flag
 ⁸⁵	Temperature limiting value	G.Output	1 bytes	5,010	C, R, -, T, -

Description The temperature limiting value defined in the parameters must be exceeded or undershot so that this communication object can optionally transmit a telegram to the KNX. The parameter "Limiting value function" defines whether the KNX telegram is transmitted when the value is exceeded or undershot. The data format of the communication object "G.Output temperature limiting value" can be defined as a 1-bit object or as a 1-byte object. The 1-byte limiting value object sends configurable values between 0 and 255 to the KNX according to the defined thresholds. These values define the parameters "Value at ON" and "Value at OFF".

4.2.4 Functional description

4.2.4.1 General settings

Telegram rate limit

It is possible to configure a general telegram rate limit using the parameter of the same name on the "General" parameter page. If the telegram rate limit is enabled, no more telegrams are transmitted to the KNX in 17 seconds (permanently defined, cyclical time interval) than is specified in the ETS. This avoids fast edge changes at the inputs causing an impermissibly high bus load.

-  A telegram rate limit does not influence a configured delay after a reset or bus voltage return. These two functions can be combined in any way.

Delay after reset or when bus voltage returns

To reduce telegram traffic on the KNX line after bus voltage switch-on (reset), after connection of the device to the KNX line or after programming with the ETS, it is possible to delay all actively transmitting telegrams of the device. For this purpose, a function-independent delay can be specified (parameter "Delay after reset or bus voltage return" in the parameter node "General"). Only after the configured time elapses are telegrams transmitted to the KNX.

4.2.4.2 Valve drive

Basic functions of the valve drive

The device uses a low-noise drive to implement command values received via the KNX or set by the internal room temperature controller, by infinitely adjusting the valve to the appropriate position. The current actual position of the valve is output to the KNX via the communication object "V.Actual position".

The valve setting display (Figure 2) is used for rough orientation, in addition to this very precise position data. It also shows in which position the valve is currently located. In so doing, the valve setting display moves infinitely with the adjustment of the valve. It is not possible to read off the valve position percentage accurately on the valve setting display, on account of the rough scale.

The valve drive sets the valve based on the received command value. The device can process command values as an 8-bit value (Continuous PI control) or as a 1-bit switching function (Switching 2-point feedback control).

It is not important whether the command value is transmitted by the internal device room temperature controller or an external one. During project design, ensure that the room temperature controller and command value are matched. The standardised format of the command value is relevant here. The parameter "Command value is received as" defines the data format for the receiving communication object "V.Command value".

- i** The settings of the parameters "Valve drive control via" (parameter page "Valve drive") and "Operating mode" (parameter page "Controller general") must be adjusted to each other. The settings "Internal command value ..." define that the presetting of the command values is made internally by the room temperature controller. The parameter "Command value is received as" is automatically set when setting the "Internal command value..." in accordance with the configured control type (parameter page "Room temperature controller" -> "Controller general").

The default position is defined on the "Valve drive" parameter page. After successful self-adjustment, the set percentage value is set by the valve drive, if no valid command value telegram was received after bus voltage return or an ETS programming operation. In addition, the default position is approached during emergency operation, if emergency operation is not to function with the values of the internal temperature sensor and the internal room temperature controller.

To prevent calcification or sticking of a valve which has not been activated for some time, the valve drive has an automatic valve rinsing function. Valve rinsing can be executed cyclically or using a bus command, causing the activated valve to run through the full valve stroke for a preset period of time. If necessary, the intelligent valve rinsing can be enabled.

Priorities

The valve drive distinguishes between different functions and events. Because these functions and events cannot be executed simultaneously, there must be priority control. The function or the event with the higher priority overrides the lower-priority functions and events.

The following priorities are defined:

- Valve rinsing
- Forced position
- Command value limit
- Emergency operation
- Normal operation

Functional unit

The device is suitable for mounting on thermostat valve bases. Together with the suitable thermostat valve base, the valve drive forms a functional unit for room temperature control. The principle diagram of the functional unit clarifies the joint action of the valve drive and thermostat valve.

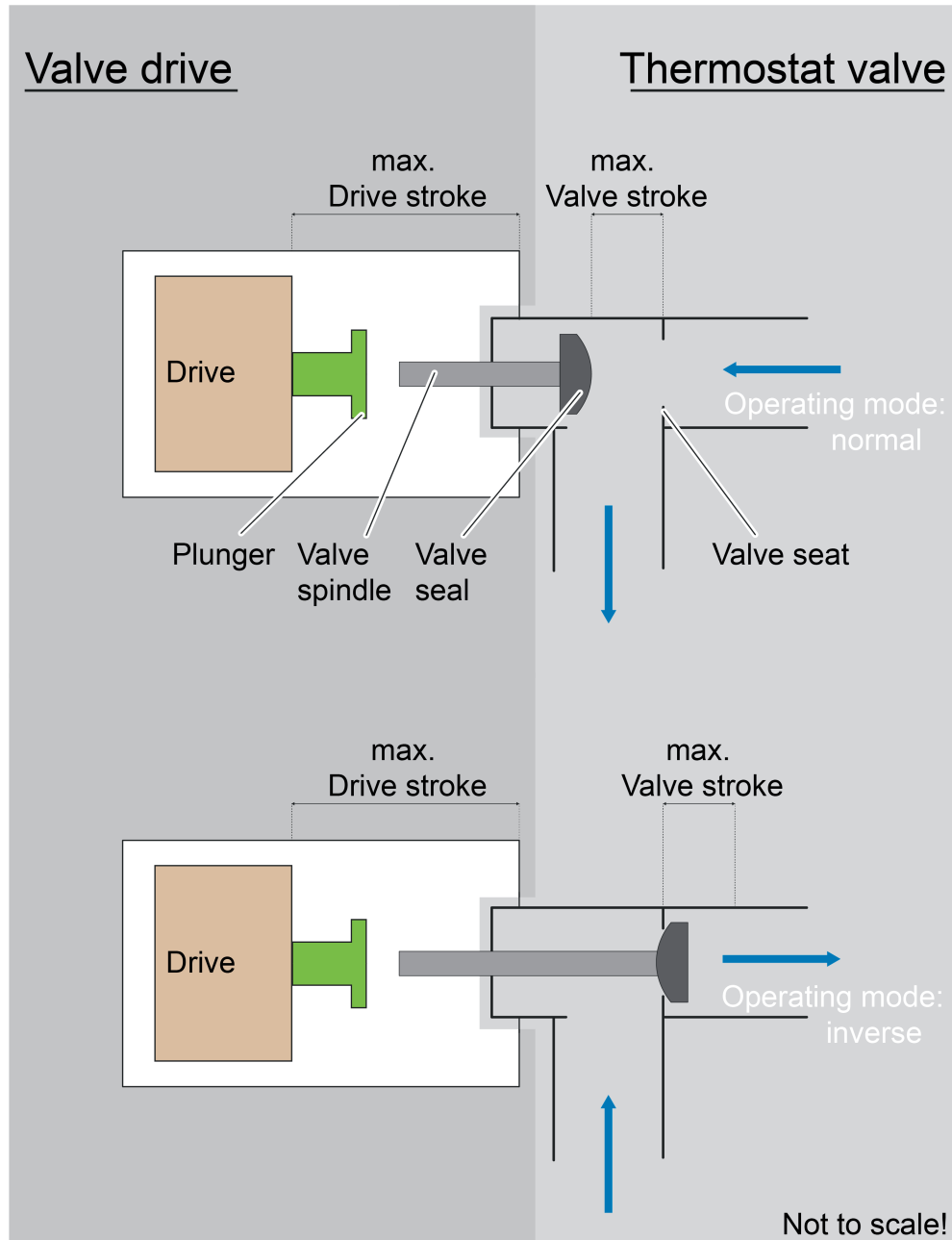

Figure 10: Principle sketch of the functional unit

Behaviour in case of bus voltage failure

If there is a bus voltage failure, the valve drive remains at the most recently set command value. Only after the bus voltage return is the device able to receive and implement new command value telegrams.

- i** If, at the time of a bus voltage failure, the valve is completely closed (normal -> command value 0%; inverse -> command value 100%), then the pipeline may freeze. A burst pipe could be the consequence of frost damage.

4.2.4.2.1 Self-adjustment

Self-adjustment of the valve drive

The valve drive can be screwed onto various thermostat valve bases. The valve drive performs automatic self-adjustment after the device has been connected to the KNX and supplied with bus voltage. This self-adjustment takes place after bus voltage return or after an ETS programming operation.

Self-adjustment also takes place according to the number of received command value telegrams or the number of command value changes. The criterion is defined by the parameter "Start self-adjustment in dependence of the number". The number is preset to 4096. The value can be calibrated using the parameter "Number of motor movements / object values until new adjustment". During self-adjustment, the valve drive calibrates itself to the valve by the valve drive opening the plunger to the full and then closing it again. After this, the plunger is moved to the lifting point (plunger lifts off of the valve spindle). When this lifting point is detected, the valve drive sets the designed "Default position". The self-adjustment is thus completed.

The self-adjustment operation takes between a few seconds and a couple of minutes, depending on the combination of valve drive and thermostat valve base. Optionally, a KNX telegram can be transmitted when the valve drive carries out self-adjustment. At the beginning of self-adjustment, the communication object V.Fault transmits a "1" to the KNX if the "Fault message" parameter is set to "On telegram on adjustment operation". When self-adjustment has been completed, the device transmits a "0" to the KNX.

After self-adjustment, the valve drive converts the command values specified by the room temperature controller exactly on the valve, thus allowing an optimum control result. The valve drive will perform the self-adjustment procedure a maximum of three times in succession. If self-adjustment cannot be completed successfully in this procedure, then the valve drive will switch to the "Fault" status.

The valve drive cannot complete self-adjustment successfully in the following cases:

- The valve drive is not correctly screwed to the thermostat valve base.
- The valve stroke of the thermostat valve base is too large or too small.
- The valve spindle of the thermostat valve base is stuck.
- During self-adjustment, the plunger is not located on the valve spindle.

The adjustment error (error occurring during self-adjustment) is signalled by the Programming/Status LED flashing. This fault is optionally signalled via a KNX telegram ("ON' - Telegram on adjustment error"). The adjustment error can only be eliminated by a switch-off of the bus voltage, elimination of the error and subsequent bus voltage return. Further fault messages can be triggered during self-adjustment ("ON' - Telegram during adjustment operation") or after no command value has been received in the monitoring period ("ON' - Telegram on controller timeout").

4.2.4.2.2 Data formats for command values

The valve drive receives 1-bit or 8-bit command value telegrams, transmitted, for example, by KNX room temperature controllers. Usually, the room temperature controller determines the room temperature and generates the command value telegrams using a control algorithm.

- i** The valve drive implements received command value telegrams or command value specifications from device functions in constant output signals.

The parameter "Command value is received as" specifies the input format of the command value objects.

Data format of the command value input "1-bit switching function"

In the case of a 1-bit command value (Switching 2-point control), the telegram received via the command value object is implemented directly. Depending on the designed "Command value for object value ...", the valve drive sets the defined command value with a "1" or a "0" telegram.

Data format of the command value input "8-bit value"

A room temperature controller calculates the continuous command value and transmits it to the KNX on a change or cyclically. The valve drive receives this 8-bit command value (Continuous PI control) via the command value object and implements it by infinitely adjusting the plunger to the received value. Received command values outside the command value limit if the limit is active are limited by the valve drive.

- i** The value of this parameter is permanently set accordance with the configured control type (parameter page "Room temperature controller" -> "Controller general") if the parameter "Valve drive control via" is set to an internal command value.
- i** This parameter is not visible if the parameters "Valve drive control via" (parameter page "Valve drive") and "Operating mode" (parameter page "Controller general") are not adjusted to each other.
- i** The valve drive cannot process PWM signals (Switching PI control).

4.2.4.2.3 Operating mode

In the device parameters, the valve drive is adapted to the operating mode of the valve. With regard to the valve used, the valve drive can control valves which are opened or closed in the deenergised state. The "Operating mode" parameter on the "Command value" parameter page defines whether the valve is opened or closed on the command value 0 %. In the standard project design, the valve is opened at 100 % and closed at 0 %.

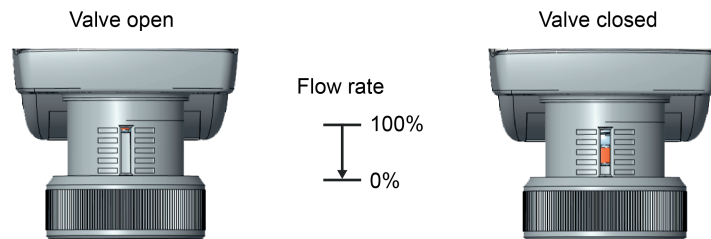

Figure 11: Normal (command value 0% -> valve closed)

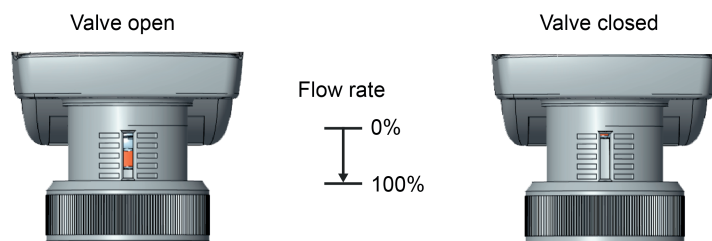

Figure 12: Inverse (command value 0% -> valve open)

4.2.4.2.4 Status function

Command value status

The valve drive possesses a status object. After the termination of an adjustment, the status object "V.Actual position" makes the active command value of the valve drive available either actively transmitting or passively (object can be read out). During status feedback, the valve drive takes all the functions into account which have an influence on the command value implemented at the output. Depending on the configured data format of the input command value, the status object possesses the following data format:

- Command value is received as "8-bit value":
Data format of status object "1-byte",
- Command value is received as "1-bit switching function":
Data format of status object "1-byte".

Setting the type of the command value status function

The status feedback can be used as an active signal object or as a passive status object. As an active signal object, the feedback is also directly transmitted to the KNX whenever there is a change to the status value. As a passive status object, there is no telegram transmission after a change. In this case, the object value must be read out. The function of the active signalling object is preset. The communication object can be read out via the KNX if the Read flag is set in the ETS.

The parameter "Object transmits 'Actual position'" defines the command value status:

- Actual valve position:

The valve drive transmits the actual position to the KNX (0...100% = 0...255). Depending on the characteristic curve of the valve type, received command values may deviate from the actual position. The flow rate relative to the valve stroke is of importance here. This value does not necessarily equal the value of the received command value.

- linearised actual position:

The valve drive transmits the actual position, taking the characteristic curve adjustment into account. Depending on the characteristic curve of the valve type, received command values may deviate from the actual position. The flow rate relative to the valve stroke is of importance here. In this setting, the received command value is also always output via the status object "V.Actual position". The valve drive sets the actual valve position, according to the received command value, and transmits the linearised actual position back to the KNX.

Characteristic curve

The device determines the drive stroke to be set according to the received command value using a characteristic curve. The parameter "Valve type" on the parameter page "Valve drive -> Advanced" adjusts the characteristic curve to the connected value. The characteristic curve data of the valve type "Standard value" corresponds to a linear characteristic curve, meaning that the received command value corresponds to the actual valve position to be set and the linearised actual position.

The comparison of the characteristic curve data of the valve type "Standard valve" and "Optimised for Heimeier standard up to 1/2 inches" shows that the characteristic curve of the valve type "Optimised for Heimeier standard up to 1/2 inches" achieves a more rapid increase of the actuating valve relative to the setpoint with setpoint specifications in the range 0...10%. (Figure 13).

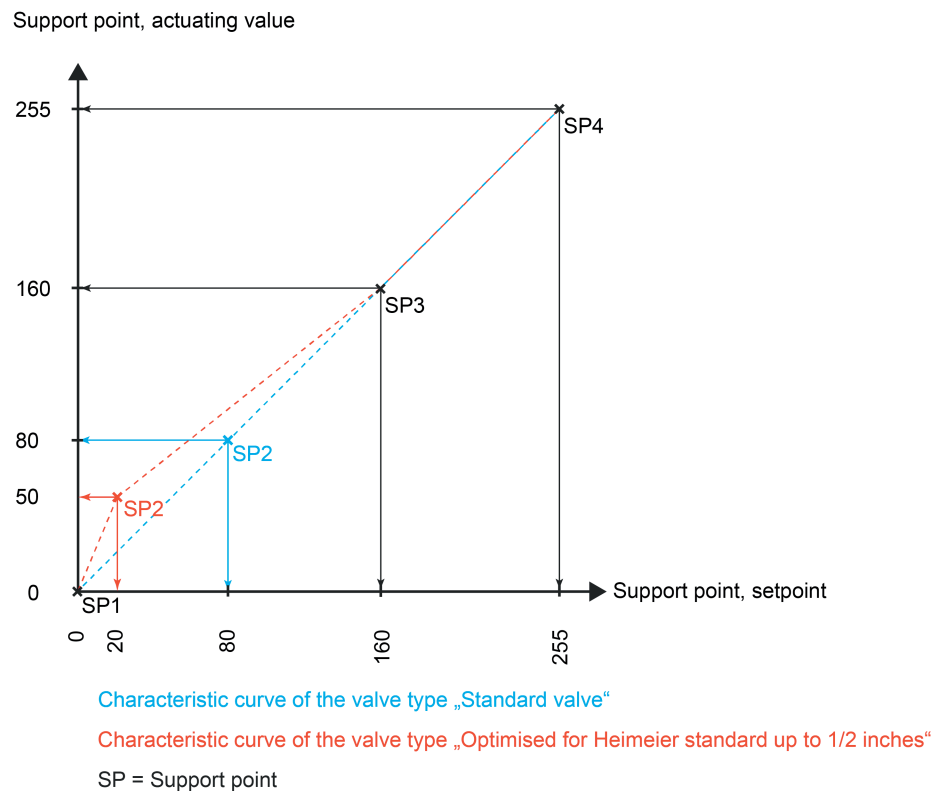

Figure 13: Characteristic curve diagram

Characteristic curve adjustment

The characteristic curve is calibrated on the parameter page "Valve parameters". A characteristic curve is produced depending on the configured support points for the setpoint and the actuating value. Using this characteristic curve, the valve drive determines the drive stroke to be set according to the received command value.

This parameter page is only visible if, on the "Advanced" parameter page, the selection "User-defined valve" was selected under "Valve type" and the correct enabling code was entered.

- i Access to the user-defined valve settings is only intended for the manufacturer and specially-trained people and is gained by entering a fixed numeric code.

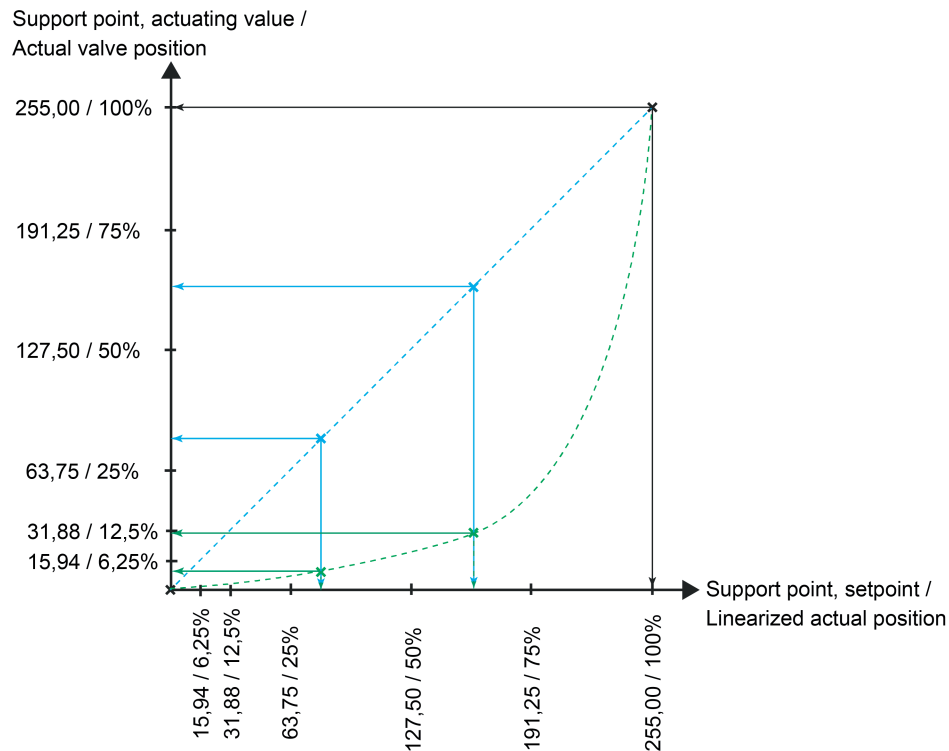

Figure 14: Characteristic curve diagram (fictitious) for the "Actual position" object

Case example 1 (blue characteristic curve):

Standard configuration of the support point setpoints (standard valve)

Precondition: Operating mode = Normal (command value 0% -> valve closed)

- First support point, setpoint: 0;
Second support point, setpoint: 80;
Third support point, setpoint: 160;
Fourth support point, setpoint: 255
- First support point, actuating value: 0;
Second support point, actuating value: 80;
Third support point, actuating value: 160;
Fourth support point, actuating value: 255

Result: The actual valve position corresponds to the linearised actual position.
The following values are fed back by the status object:

Example	Received command value (V.Command value)	Actual valve position (V.Actual position)	linearised actual position (V.Actual position)
1	25%	25%	25%
2	50%	50%	50%
3	75%	75%	75%

Case example 2 (green characteristic curve):

Fictitious configuration of the support point setpoints (freely-created example)

Precondition: Operating mode = Normal (command value 0% -> valve closed)

- First support point, setpoint: 0;
Second support point, setpoint: 80;
Third support point, setpoint: 160;
Fourth support point, setpoint: 255
- First support point, actuating value: 0;
Second support point, actuating value: 10;
Third support point, actuating value: 30;
Fourth support point, actuating value: 255

Result: The actual valve position does not correspond to the linearised actual position.
The following values are fed back by the status object:

Example	Received command value (V.Command value)	Actual valve position (V.Actual position)	linearised actual position (V.Actual position)
1	25%	3%	25%
2	50%	8%	50%
3	75%	40%	75%

Result: The feedback telegram is transmitted as soon as the status changes. An automatic telegram transmission of the feedback takes place after bus voltage return, if the supply voltage of the actuators fails and returns or after an ETS programming operation (possibly with a delay).

- i The status object does not transmit if the status does not change after the activation or deactivation of device functions or new input command values. Transmission only ever takes place after changes to the command value.

4.2.4.2.5 Monitoring of the command value / Emergency operation

If necessary, cyclical monitoring of the command values can be performed. This monitors the function of the external room temperature controller and the external temperature sensor. If, during active cyclical monitoring, there are no command value telegrams during a specified time, then emergency operation is activated, for which either a configurable constant command value ("Default position") can be specified in the ETS or work is carried out with the internal temperature sensor and controller.

Monitoring of the command value telegrams is only possible when the room temperature controller function has been switched off. If the room temperature controller is switched on, monitoring is deactivated and the monitoring parameters are not visible in the ETS.

In the "Default position" setting, the valve drive sets the command value, to which the parameter "Default position, command value on initialisation" is set, at the beginning of emergency operation.

If valve drive monitoring is enabled, then the actuator will check the arrival of telegrams at the command value object during a settable time period. The time period is defined by the "Monitoring time" parameter. The time set there should be at least double the time for the cyclical transmission of the command value of the controller, in order to ensure that at least one telegram is received within the monitoring time. Cyclical command value monitoring takes place continuously. The valve drive retriggers the monitoring time automatically on each command value telegram received and after a device reset. If there are no command value telegrams during the monitoring time, then the valve drive will activate emergency operation.

The command value of emergency operation is always constant. Either the command value is configured in the ETS by the parameter "Default position, command value on initialisation" (0...100 % in 10 % steps) or the valve drive works in emergency operation with the command values of the internal controller. The "Emergency operation" parameter decides whether the valve drive works with the internal values in emergency operation or the valve is set to the default position. In emergency operation with an internal temperature sensor and controller, the parameters relevant for emergency operation must be set on the "Controller, emergency operation" parameter page. These parameters define the operating mode and the setpoint temperature of the room temperature controller. A further parameter is used to adapt the PI algorithm to different heating or cooling systems during emergency operation.

According to the priority control, active command value monitoring can be overridden by other device functions with a higher priority (e.g. valve rinsing, forced position). At the end of a higher priority function, the valve drive executes emergency operation once again, if it is still activated by missing command value telegrams.

At the end of emergency operation (new input command value received), the behaviour is permanently defined. If no function with a higher priority is active, the valve drive always tracks the state for the valve most recently preset by normal bus operation (activation by command value telegrams).

The valve drive makes the 1-bit status telegram "V.Fault" available. As soon as a command value telegram is missing in cyclical monitoring, and thus emergency operation is activated, then the valve drive transmits a fault signal via this status object, if the "Fault message" parameter is set to "ON - Telegram on controller timeout". Only after at least one command value telegram has been received does the valve drive retract the fault signal for cyclical monitoring. If the fault message is not used or is used for another message, active emergency operation is not transmitted via a KNX telegram.

Enable cyclical command value monitoring

Precondition: Cyclical command value monitoring can only be used if it has been enabled in the ETS.

- Set the "Monitoring of the command value" parameter on the "Valve drive" parameter page to "Yes".
- Configure the "Monitoring time" of the command value monitoring.
- Define the function of "Emergency operation" to "Default position" or "With internal temperature sensor and controller".

Result: Cyclical command value monitoring is activated. If there are no command value telegrams during the monitoring time defined by the parameter of the same name, emergency operation will be activated.

Disable cyclical command value monitoring

- Set the "Command value monitoring" parameter to "No".

Result: Cyclical command value monitoring is deactivated.

Configuring the fault signal for cyclical command value monitoring

If a command value fault is identified, then the valve drive can optionally transmit a fault telegram via the object "V.Fault".

- Set the parameter "Fault message" on the parameter page "Extended" to "ON - Telegram on controller timeout".

Result: As soon as a command value telegram is missing, and thus emergency operation is activated, then the valve drive transmits a fault signal via the status object "V.Fault". Only after at least one command value telegram has been received does the valve drive retract the fault signal for cyclical monitoring.

4.2.4.2.6 Valve rinsing

To prevent calcification or sticking of a valve which has not been activated for some time, the valve drive has an automatic valve rinsing function. Valve rinsing can be executed cyclically or using a KNX command, causing the connected valve to run through the full valve stroke for a preset period of time. During valve rinsing, the valve drive activates a command value of 100 % without interruption for the valve for the "Valve rinsing time". For this, the valve opens completely. After the time has elapsed, valve rinsing stops. The valve drive moves back to that command value active before valve rinsing.

If necessary, the intelligent valve rinsing can be enabled. In so doing, cyclical rinsing using the full stroke is only executed when a defined minimum command value limiting value was not exceeded during valve drive operation.

At the end of valve rinsing, the device automatically sets the tracked command value according to the priority control (see chapter 4.2.4.2. Valve drive).

i The object transmits the current status after bus and mains voltage return and after an ETS programming operation without a delay.

Valve rinsing possesses a separate 1-bit status object. Optionally, this object can be used, for example, to display a KNX visualisation that valve rinsing is taking place (rinse operation time running). The status telegram can be used, for example, to disable a KNX room temperature controller for the length of the valve rinsing. Particularly in the case of long rinsing times, the disabling of the room temperature controller, possibly in combination with the disabling of the controller operation, can make a positive contribution to the suppression of the oscillation behaviour of the controller. The telegram polarity of the status object is fixed: "0" = Valve rinsing inactive, "1" = Valve rinsing active.

i The object transmits the current status after bus and mains voltage return and after an ETS programming operation without a delay.

Enabling valve rinsing

Valve rinsing can only be used if it has been enabled in the ETS.

- Set the parameter "Use valve rinsing" on the parameter page "Valve rinsing" to "Yes". In the "Valve rinsing time" parameter, configure for how long the rinse function (valve closed - > valve opened) is to be executed.

Result: Valve rinsing is enabled. Additional parameters become visible in the ETS, presetting whether valve rinsing is to be activated cyclically and / or with KNX control.

- Set the "Use valve rinsing" parameter to "No".

Result: Valve rinsing is not available.

Configuring cyclical valve rinsing

The valve drive can perform valve rinsing cyclically, if necessary. When using the cyclical valve rinsing, a rinse operation can be started automatically after a configurable cycle time (1...26 weeks). Here too, the valve rinsing length configured in the ETS defines the time for the once-only, complete opening and closing of the activated valves. At the end of a rinsing operation, the valve drive always restarts the cycle time. The valve drive possesses an internal clock. This checks, in a 24-hour cycle, the designed cycle time in weeks. After the projected cycle time has elapsed, the device begins cyclical valve rinsing.

Precondition: Valve rinsing must be enabled and a valid rinsing time configured.

- Set the "Cyclical valve rinsing" parameter to "Yes". In the case of the "Cycle time of cyclical valve rinsing" parameter, configure how often valve rinsing is to be performed automatically.

Result: Cyclical valve rinsing is enabled.

- Set the "Cyclical valve rinsing" parameter to "No".

Result: Cyclical valve rinsing is completely disabled. Valve rinsing can only be started by the communication object (if enabled).

- i** Each ETS programming operation resets the cycle time. The first rinsing operation with cyclical valve rinsing takes place after an ETS programming operation after the first time cycle has elapsed.

Preventing cyclical valve rinsing at night

The device can prevent cyclical valve rinsing at night. There are two options for preventing cyclical valve rinsing at night.

The first option is to synchronise the internal clock of the device, for which the 3-byte communication object "V.Time" can be enabled. In this case, cyclical valve rising begins at 10:00 a.m. at the earliest and at 6:00 p.m. at the latest. The internal clock of the device runs with a small gait deviation, which increases over time. For this reason, the internal clock should be synchronised with the KNX on a regular basis.

The second option for preventing cyclical valve rinsing at night is the 1-bit communication object "V.Day / Night", which specifies the time. A KNX telegram tells the device whether it is day ("1") or night ("0"). If cyclical valve rinsing is to be performed during a night phase, then this is suppressed until this communication object receives a "1" telegram for day. Cyclical valve rinsing is carried out as planned as soon as the device is back in a day phase.

The parameter "Time object" makes the appropriate communication object visible to prevent cyclical valve rinsing at night.

Yes setting: The 3-byte communication object "V.Time" is visible for specifying the current time.

No setting: The 1-byte communication object "V.Day / Night" is visible for specifying the time.

Intelligent valve rinsing

Optionally, intelligent cyclical valve rinsing can be additionally activated. Here, valve rinsing is only executed repeatedly, if, in the current time cycle, a minimum command value limiting value, configurable in the ETS, was not exceeded. If the active command value exceeds the limiting value, then the valve drive will stop the cycle time. The valve drive only restarts the cycle time if, in the further course of the command value change, a command value of "0 %" or "OFF" (completely closed) is set. This prevents valve rinsing if the valve has already run through a sufficiently defined stroke.

If, after exceeding the configured limiting value, the value was not completely closed at least once (command value "0 %" or "OFF"), then no further cyclical valve rinsing will take place.

Use of the intelligent cyclical valve rinsing means that rinsing operations over the entire valve stroke are only then used when this is sensible and actually required. For example, in the summer months, the use of heating power is lower. In consequence, the valves are activated less frequently by command values, meaning that valve rinsing should be performed as anti-sticking protection. In the winter months, it is frequent necessary to activate heating valves using normal command value telegrams.

The intelligent valve rinsing ensures that no redundant valve rinsing is not performed in the winter. In the summer, the intelligent control performs valve rinsing cyclically.

- i** The cycle time is always started after an ETS programming operation.
- i** The combination of intelligent valve rinsing with a command value limit with a minimum command value limiting value is not recommended. If a minimum limiting value of the command value limit exists, then the active command value of the affected valve output is never "0 %". In consequence, the valve drive would never restart the cycle time as part of intelligent valve rinsing.

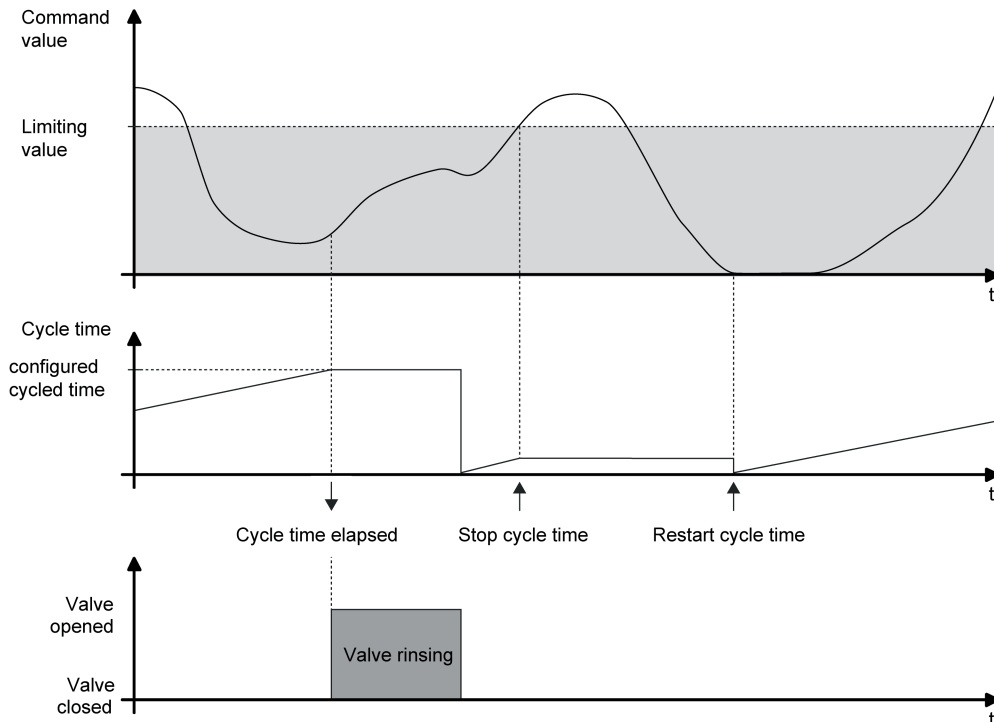

Figure 15: Example of a minimum command value limiting value for intelligent valve rinsing

- Set the "Use intelligent valve rinsing ?" parameter to "yes". Using the "Limiting value minimum command value (10...100 %)" parameter, define the command value limiting value.

Result: Intelligent cyclical valve rinsing is activated. Valve rinsing is only executed when the configured limiting value was exceeded at least once in the previous time cycle and, consequently, the valve was run to the "0 %" command value.
- Set the "Use intelligent valve rinsing ?" parameter to "no".

Result: Intelligent cyclical valve rinsing is deactivated. Valve rinsing always takes place as soon as the set cycle time has expired.
- i** Valve rinsing can optionally be started and, if required, stopped using a communication object. If valve rinsing was started by the object, then the actuator will stop the cycle time of the cyclical valve rinsing operation. The cycle time is only restarted after the rinsing operation has been fully executed without interruption or a stop command was received via the object.

Configuring bus-controlled valve rinsing via an object

If necessary, valve rinsing can be started and, optionally, stopped using its own 1-bit communication object. This means that it is possible to activate a rinsing operation of the valve controlled by time or an event.

Bus control can only be used if it has been enabled in the ETS.

Precondition: Valve rinsing must be enabled and a valid "Valve rinsing time" configured.

- Set the "Valve rinsing activated externally ?" parameter to "yes". In the case of the parameter "Polarity of 'Start / stop valve rinsing' object", configure the telegram polarity, thus presetting whether the bus-controlled starting and stopping, or, alternatively, only starting, should be possible.

Result: Bus-controlled valve rinsing is enabled. The communication object is visible. The name of the object is aligned to the setting of the permitted telegram polarity ("Start / stop valve rinsing" or "Start valve rinsing"). When a start command is received, the valve drive immediately starts the configured time for a rinsing operation. If bus-controlled stopping is permitted, then the valve drive will also react to stop commands by immediately interrupting running rinsing operations.

- Set the "Valve rinsing activated externally ?" parameter to "no".

Result: Bus-controlled valve rinsing is not available. Valve rinsing can only take place cyclically.

- i Updates of the object from "Start" to "Start" or "Stop" to "Stop" do not produce a reaction. The length of an elapsing valve rinsing operation or the cycle time of a cyclical valve rinsing operation are not restarted by this.
- i Bus-controlled valve rinsing via the object can be combined with a cyclical valve rinsing operation. If valve rinsing was started by the object, then the valve drive will stop the cycle time of the cyclical valve rinsing operation. The cycle time is only restarted after the rinsing operation has been fully executed without interruption or a stop command was received via the object.

4.2.4.2.7 Forced position

Two forced positions could be configured for the valve drive and activated according to requirements. If a forced position is active, the valve drive sets a defined command value. The valve is then locked so that it can no longer be activated using functions subject to the forced position (including activation by command value telegrams).

The command value of the forced position is always constant and is configured individually in the ETS (0...100 % in 10 % steps).

The forced position is activated and deactivated via a separate 1-bit object. The telegram polarity can be configured.

The behaviour at the end of the forced position can be designed. Either the valve drive waits for the next command value telegram or the last command value set before the forced position was set.

Enabling the forced position object and configuring the forced position

For the forced position to be used as a locking function, it must first be enabled in the ETS on the parameter page "Forced position" and be visibly switched by the communication object.

- Set the parameter "Activation of forced position x" to "Active on object value 1" or "Active on object value 0".

Result: The forced position object is enabled. The affected valve output is locked by a telegram according to the polarity at the defined command value.

If both forced positions have been enabled, the parameter "Highest priority" defines whether forced position 1 or forced position 2 should be considered the higher.

- Set the parameter "Activation of forced position x" to "Forced position inactive".
Result: The forced position object is not enabled. The forced position for locking the valve output is not possible.
- ❗ Updates of the object from "Forced position active" to "Forced position active" or from "Forced position inactive" to "Forced position inactive" produce no reaction.
- ❗ After an ETS programming operation or a bus voltage failure, a forced position is always deactivated and the forced position object is "0". In the polarity "0" = Forced position active / "1" = No forced position, a "0" telegram must first be received to activate the forced position.

4.2.4.2.8 Command value limit

Optionally, a command value limit can be used for the valve drive. The command value limit allows the restriction of the command values received via the bus or emergency operation commands during a command value limit to the range limits "minimum" and "maximum". A minimum command value can be used, for example, for the implementation of basic heating or cooling. A maximum command value allows the limitation of the effective command value range, which usually has a positive influence on the lifespan of actuators. The limits are permanently set in the ETS and, if command value limitation is active, can be neither undershot or exceeded during device operation.

As soon as the command value limit is active, received command values or those preset via emergency operation are limited according to the limiting values from the ETS. The behaviour with regard to the minimum or maximum command value is then as follows...

- Minimum command value:
The "Minimum command value" parameter specifies the lower command value limiting value. The setting can be made in 5 % increments in the range 0 % ... 50 %. With an active command value limit, the set minimum command value is not undershot by command values. If the valve drive receives smaller specified command values (including 0 %), it sets the configured minimum command value.
- Maximum command value:
The "Maximum command value" parameter specifies the upper command value limiting value. The setting can be made in 5 % increments in the range 55 %...100 %. With an active command value limit, the set maximum command value is not exceeded. Should the valve drive receive larger specified command values, it sets the configured maximum command value.

i With a designed "1-bit switching function", command values must be specified for the object values "0" and "1". These specifications are overridden if there is an active command value limit, if the command values for the object values "0" and "1" are outside the set value range for the command value limit.

If the command value limit is removed, the valve drive automatically tracks the most recently preset command value to the unlimited values.

Enabling the minimum command value limit

The command value limit can only be used if it has been enabled in the ETS.

- Set the parameter "Activation of min. limit" on the parameter page to "Active on object value 1", "Active on object value 0" or "Always active".
Result: The command value limit is enabled. The "Activation of the min. limit" parameter defines whether the limiting function can be activated or deactivated as required via a communication object. Alternatively, the command value limit can be permanently active.

Disabling the minimum command value limit

- Set the "Activation of min. limit" parameter on the parameter page to "Limitation inactive".
Result: The limitation of the minimum command value is not available.

Enabling the maximum command value limit

The command value limit can only be used if it has been enabled in the ETS.

- Set the parameter "Activation of max. limit" on the parameter page to "Active on object value 1", "Active on object value 0" or "Always active".

Result: The command value limit is enabled. The "Activation of the max. limit" parameter defines whether the limiting function can be activated or deactivated as required via a communication object. Alternatively, the command value limit can be permanently active.

Disabling the maximum command value limit

- Set the "Activation of max. limit" parameter on the parameter page to "Limitation inactive".
Result: The limitation of the maximum command value is not available.

Setting the activation of the command value limit

The "Activation of min. limit" and "Activation of max. limit" parameters on the "Limitation" parameter page define the action of the limit function.

The command value limit must be enabled.

- Set the parameter to "Active on object value 1" or "Active on object value 0".
The limit of the minimum command value can only be activated and deactivated by the 1-bit communication object "V.Min.limit".
The limit of the maximum command value can only be activated and deactivated by the 1-bit communication object "V.Max.limit".
- Set the parameter to "Always activated".
The command value limit is permanently active. It cannot be influenced via an object. Command values preset via the KNX or via emergency operation are always limited.

4.2.4.2.9 Limiting value message

A limiting value can be configured for the valve drive. If a limiting value is exceeded or fallen below, the valve drive sends an "ON" telegram to the KNX. This limiting value message can be evaluated or visualised by other KNX subscribers.

Enabling the limiting value message and configuring the limiting value message

For the limiting value message to be used, it must first be enabled in the ETS on the parameter page "Limiting value" and be visibly switched by the communication object.

- Set the parameter "Limiting value message" to "ON telegram on exceeded" or "ON telegram if fallen below".
- Select the required command value limiting value from the list of the "Limiting value" parameter.

Result: The "V.Limiting value" object is enabled. Depending on the configuration, the valve drive signals a "1" if the limiting value is exceeded or fallen below. As soon as the limiting value range has been left, the status of the communication object changes to "0".

4.2.4.2.10 Fault message

A fault message can be configured for the valve drive. If there is an active fault, the valve drive transmits an "ON" telegram to the KNX. This fault message can be evaluated or visualised by other KNX subscribers.

The valve drive makes three possible fault messages available:

- "ON" telegram for adjustment error
The 1-bit output object signals a failed self-adjustment. The error can only be eliminated with a repeated self-adjustment (bus voltage failure and return or ETS programming operation). This acknowledges the fault message in the same way.
- "ON" telegram for adjustment mode
The 1-bit output object signals an active self-adjustment. After self-adjustment is completed, the status of the communication object changes to "0".
- "ON" telegram for controller timeout
1-bit output object to signal a faulty command value (with active command value monitoring, no command value telegram was received within the monitoring time). Immediately after the bus voltage return or an ETS programming operation, the object "Command value fault" does not transmit the status automatically. A faulty command value must be detected again (expiry of the monitoring time without a command value telegram) for the object value to be transmitted.

Depending on the configuration, the limiting value optionally executes one of these fault messages.

Enabling the fault message object and configuring the fault message

For the fault message to be used, it must first be enabled in the ETS on the parameter page "Fault message" and be visibly switched by the communication object.

- Set the parameter "Fault message" to "ON telegram on adjustment error", "ON telegram for adjustment operation" or "ON telegram on controller timeout".

Result: The "V.Fault" object is enabled. Depending on the configuration, the valve drive signals a "1" on an adjustment error, adjustment operation or a controller timeout. As soon as the fault has been eliminated, the status of the communication object changes to "0".

4.2.4.2.11 Application examples

Valve drive with external room temperature controller

The input object "V.Command value" should be connected to the communication object the external room temperature controller, which transmits the command value to be set on the KNX, via a group address. Multiple valve drives can be activated by a room temperature controller. The device implements the command values received at the input object "V.Command value" by infinitely adjusting the plunger to the received value. The actually set position can be read out via the communication object "V.Actual position".

Valve drive with internal room temperature controller and received temperature value

Only for application program version "1.2":

The room temperature controller determines the command values and transmits them internally to the valve drive. The transmitted command values are also transferred to the KNX via the communication object "Command value..." of the internal room temperature controller. The designation of the output object "Command value ..." changes according to the set operating mode of the room temperature controller (command value heating, command value cooling, command value heating/cooling). In this case, the room temperature controller works with received temperature values. The externally measured temperature is received via the object "Received temperature". The received temperature value can be calibrated in the room temperature measurement parameters. The internal room controller always works with the calibrated temperature value (communication object "Actual temperature").

If multiple valve drives are operated in a room, Master-Slave operation can be set up. For this, a device is designated as the Master valve drive. Ideally, this would be the one best suited for room temperature control. This device should assume control and supply all the other valve drives with command values.

The device implements the internally transferred command values by infinitely adjusting the plunger to the received value. The actually set position can be read out via the communication object "V.Actual position".

Only for application program version "1.1":

The input object "V.Command value" should be connected to the communication object "Command value..." of the internal room temperature controller via a group address. The designation of the output object "Command value ..." changes according to the set operating mode of the room temperature controller (command value heating, command value cooling, command value heating/cooling). In this case, the room temperature controller works with received temperature values. The externally measured temperature is received via the object "Received temperature". The received temperature value can be calibrated in the room temperature measurement parameters. The internal room controller always works with the calibrated temperature value (communication object "Actual temperature").

If multiple valve drives are operated in a room, Master-Slave operation can be set up. For this, a device is designated as the Master valve drive. Ideally, this would be the one best suited for room temperature control. This device should assume control and supply all the other valve drives with command values.

The device implements the command values received at the input object "V.Command value" by infinitely adjusting the plunger to the received value. The actually set position can be read out via the communication object "V.Actual position".

Valve drive with internal room temperature controller and connected remote sensor

Only for application program version "1.2":

The room temperature controller determines the command values and transmits them internally to the valve drive. The transmitted command values are also transferred to the KNX via the communication object "Command value..." of the internal room temperature controller. The designation of the output object "Command value ..." changes according to the set operating mode of the room temperature controller (command value heating, command value cooling, command value heating/cooling). In this case, the room temperature controller works with temperature values, which are measured by the remote sensor connected to the input. The measured temperature value is transmitted to the KNX via the "Non-calibrated measured value" object. The measured temperature value can be calibrated in the room temperature

measurement parameters. The calibrated temperature value is transmitted to the KNX via the "Measured value" object. The internal room controller always works with the calibrated temperature value (communication object "Actual temperature"). Should temperature detection only take place via the remote sensor, the output values of the "Measured value" and "Actual temperature" communication objects are the same.

This application is also suitable, for example, for air-conditioning systems. The mounting position of the remote sensor should then be located in the air current of the air-conditioning system. The remote sensor can also be attached in a false ceiling for temperature measurement. In addition, the device can also use a remote sensor connected in the flow of a single-pipe heater as a contact sensor and detect through the water temperature whether heating or cooling energy is required.

The device implements the internally transferred command values by infinitely adjusting the plunger to the received value. The actually set position can be read out via the communication object "V.Actual position".

Only for application program version "1.1":

The input object "V.Command value" should be connected to the communication object "Command value..." of the internal room temperature controller via a group address. The designation of the output object "Command value ..." changes according to the set operating mode of the room temperature controller (command value heating, command value cooling, command value heating/cooling). In this case, the room temperature controller works with temperature values, which are measured by the remote sensor connected to the input. The measured temperature value is transmitted to the KNX via the "Non-calibrated measured value" object. The measured temperature value can be calibrated in the room temperature measurement parameters. The calibrated temperature value is transmitted to the KNX via the "Measured value" object. The internal room controller always works with the calibrated temperature value (communication object "Actual temperature"). Should temperature detection only take place via the remote sensor, the output values of the "Measured value" and "Actual temperature" communication objects are the same.

This application is also suitable, for example, for air-conditioning systems. The mounting position of the remote sensor should then be located in the air current of the air-conditioning system. The remote sensor can also be attached in a false ceiling for temperature measurement. In addition, the device can also use a remote sensor connected in the flow of a single-pipe heater as a contact sensor and detect through the water temperature whether heating or cooling energy is required.

The device implements the command values received at the input object "V.Command value" by infinitely adjusting the plunger to the received value. The actually set position can be read out via the communication object "V.Actual position".

Valve drive with external room temperature controller and connected remote sensor

The valve drive measures the temperature via the connected remote sensor and transmits this to the external temperature controller. The measured temperature value is transmitted to the KNX via the "Non-calibrated measured value" object. The measured temperature value can be calibrated in the room temperature measurement parameters. The calibrated temperature value is transmitted to the KNX via the "Measured value" object. The "Actual temperature" communication object is suitable for determining the temperature. Should temperature detection only take place via the remote sensor, the output values of the "Measured value" and "Actual temperature" communication objects are the same.

The valve drive receives command value telegrams via the KNX.

The input object "V.Command value" should be connected to the communication object of the external room temperature controller, which transmits the command value to be set on the KNX, via a group address.

This application is also suitable, for example, for air-conditioning systems. The mounting position of the remote sensor should then be located in the air current of the air-conditioning system. The remote sensor can also be attached in a false ceiling for temperature measurement. The device implements the command values received at the input object "V.Command value" by infinitely adjusting the plunger to the received value. The actually set position can be read out via the communication object "V.Actual position".

4.2.4.3 Input

The following section contains descriptions of the various functions that can be configured in the ETS for each input. The functions "Switching", "Dimming", "Venetian blind" and "Value transmitter" can be set. The value transmitter contains the functions "Dimming value transmitter", "Light scene extension without storage function", "Light scene extension with storage function", "Temperature value transmitter" and "Brightness value transmitter". These functions are described in summary form.

Besides these functions, the input can also be used to connect a remote sensor and for temperature limiting.

4.2.4.3.1 Switching

With the "Switching" function, the ETS displays two 1-bit communication objects (switching 1.1 and 1.2). It is possible to use these two objects to transmit different switching telegrams to the KNX depending on the signal edge at the input. The input parameter on the parameter page "Input" can be used to define which object value is transmitted to the KNX when there is a rising or falling edge at the input (no reaction, ON, OFF, TOGGLE - switchover of the object value). No distinction is made between a brief or long signal edge/actuation in the "Switching" function.

Debounce time

The debounce time of the signal is defined by the device software via the parameter "Debounce time". The debounce time is defined for the functions of the binary input, after which actuation period the binary inputs identify a valid actuation of the connected contacts. In this way, it is possible to prevent the device from mistakenly identifying short conduction faults as a signal. The debounce time makes it possible to adapt the signal evaluation to the contact quality of the connected switches or push-buttons as well. The debounce time must be increased in the ETS if undesirable signal evaluations with very fast edge changes occur regularly or sporadically resulting in rapidly changing states of the KNX telegrams.

Response to bus voltage return

After a device reset (bus voltage return or ETS programming operation), the communication objects of the input can be initialised. For this, the "Behaviour on bus voltage return" parameter should be configured to the required reaction. In the settings "On telegram" or "Off telegram" telegrams are transmitted actively to the KNX according to this requirement. In the "Transmit current input status" setting, the device evaluates the static signal status of the input and, according to this, transmits the appropriately configured telegram to the KNX (contact closed at the input = telegram as with rising edge; contact open at input = telegram as with falling edge). If, in this case, the edge command dependent on the current status is configured to "No reaction", the device does not transmit a telegram to the bus on initialisation. If, in the ETS, a delay is set for the inputs after bus voltage return, the device only transmits the telegrams when the delay has elapsed.

Cyclical transmission

Optionally, the object values can be transmitted cyclically to the KNX for the "Switching" function. For this, the transmission criteria must first be defined in the ETS. The parameters "Cyclical transmission, switching object 1.X" on the parameter page "Transmit cyclically" specify at which object value cyclical transmission is to occur. Depending on requirements, it is possible to transmit cyclically via both or just one switching object(s). In addition, it is possible to define the cycle time separately for both switching objects in the ETS.

The object value entered in the switching objects by the device on a edge change or externally by the KNX is always transmitted cyclically. The object value is then also transmitted cyclically when "no reaction" is assigned to a rising or falling edge. Cyclical transmission also takes place directly after bus voltage return, if the object (possibly influenced by the parameter "Reaction

after bus voltage return") corresponds to the transmission criterion for cyclical transmission. A "Delay after bus voltage return", if configured, is expected in this case. The cyclical transmission can start automatically after bus voltage return or after an ETS programming operation. In this case, the "Delay after reset or bus voltage return" prevents the cyclical transmission. A cyclical transmission is first performed after the delay time has elapsed. During an active disable, no cyclical transmissions take place via the disabled input.

4.2.4.3.2 Dimming

With the "Dimming" function, the ETS displays a 1-bit object "Switching" and a 4-bit object "Dimming". In general, the device transmits a switching telegram on a short time input signal (triggered by the rising edge of a closed contact) and a dimming telegram on a long signal. In the standard configuration, the device transmits a telegram for stopping the dimming action after a long signal.

The length of time the input signal (closed pushbutton or switch) must last until a long actuation is detected can be set using the parameter "Time between switching and dimming" on the parameter page "Input" in seconds and milliseconds.

Debounce time

The debounce time of the signal is defined by the device software via the parameter "Debounce time". The debounce time is defined for the functions of the binary input, after which actuation period the binary inputs identify a valid actuation of the connected contacts. In this way, it is possible to prevent the device from mistakenly identifying short conduction faults as a signal. The debounce time makes it possible to adapt the signal evaluation to the contact quality of the connected switches or push-buttons as well. The debounce time must be increased in the ETS if undesirable signal evaluations with very fast edge changes occur regularly or sporadically resulting in rapidly changing states of the KNX telegrams.

Operating principle

The "Operation" parameter specifies the operating principle. In the presetting of the dimming function, dual-area operation is specified here. This means that the input transmits a telegram for switching on after a short signal length and a telegram for increasing the brightness after a long signal length ("Brighter"). Alternatively, the device can transmit a telegram for switching off after a short signal length and a telegram for reducing the brightness after a long signal length ("Darker").

With a single-surface dimming function, the input transmits switch-on and switch-off telegrams ("TOGGLE") in an alternating pattern for each short signal. After long signals, the device transmits "brighter" and "darker" telegrams in an alternating pattern.

- i** With single-surface dimming, the following should be observed: if a dimming actuator is to be controlled from several locations, a faultless single-area operation requires that the addressed actuator reports its switching state back to the 1-bit object of the input and that the 4-bit objects of all the sensors are interlinked. The sensor device would otherwise not be able to detect that the actuator has been addressed from another sensor, in which case it would have to be actuated twice during the next use in order to produce the desired reaction.

The additional input parameters on the parameter page Input can be used to specify in which step width brighter or darker dimming take place, whether a stop telegram is transmitted on a falling edge or whether the dimming telegram is to be repeated cyclically.

Response to bus voltage return

After a device reset (bus voltage return or ETS programming operation), the communication object "Switching" of the input can be initialised. For this, the "Behaviour on bus voltage return" parameter should be configured to the required reaction. In the settings "On telegram" or "Off telegram" telegrams are transmitted actively to the KNX.

If, in the ETS, a delay is set for the inputs after bus voltage return, the device only transmits the telegrams when the delay has elapsed.

After a device reset, the "Dimming" object is always initialised with "0".

4.2.4.3.3 Venetian blind

With the "Venetian blind" function, the ETS displays the two 1-bit objects "Short-time operation" and "Long-time operation".

For the control of Venetian blind, roller shutter, awning or similar drives, the device supports two operation concepts for the Venetian blind function in which the telegrams are transmitted in different time sequences. The device can therefore be used to operate a wide variety of drive configurations. In the ETS, the operating concept of an input is defined using the parameter of the same name on the parameter page "Input". The following settings are possible:

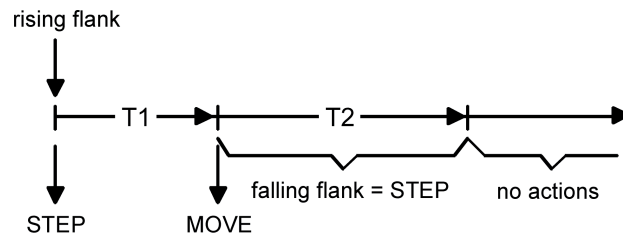

Figure 16: Operation concept "short – long – short"

Operation concept "short – long – short"

In the operation concept "short – long – short", the input shows the following behaviour:

- Immediately after a rising edge (closed push-button or switch) the input transmits a short time telegram onto the KNX. Pressing the button stops a running drive and starts time T1 ("time between short time and long time operation"). If the a falling edge is detected within T1 (closed push-button or switch), no further telegram will be transmitted. This short time serves the purpose of stopping a continuous movement. The "Time between short time and long time command" in the input parameters should be selected shorter than the short time operation of the actuator to prevent a jerky movement of the shutter.
- If the button is kept depressed longer than T1, the input transmits a long time telegram after the end of T1 for starting up the drive and time T2 ("slat adjusting time") is started.
- If a falling edge is detected within the slat adjustment time, the input transmits an additional short time telegram. This function is used for adjusting the slats of a blind. The function permits stopping the slats in any position during their rotation. The "slat adjusting time" should be chosen as required by the drive for a complete rotation of the slats. If the "slat adjusting time" is selected longer than the complete travelling time of the drive, a pushbutton function is possible as well. This means that the drive is active only when a button connected to the input is kept depressed.
- If the button is kept depressed longer than T2, the input transmits no further telegram. The drive remains on until the end position is reached.

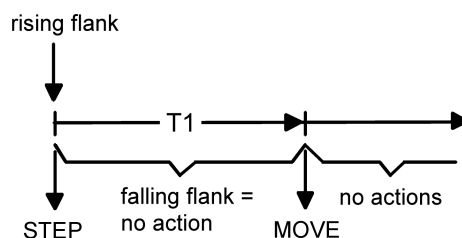

Figure 17: Operation concept "long – short"

Operation concept "long – short":

In the operation concept "long – short", the input shows the following behaviour:

- Immediately on pressing the button, the input transmits a long time telegram. The drive begins to move and time T1 ("slat adjusting time") is started.
- If a falling edge is detected within the slat adjustment time, the input transmits a short time telegram. This function is used for adjusting the slats of a blind. The function permits stopping the slats in any position during their rotation.
The "slat adjusting time" should be chosen as required by the drive for a complete rotation of the slats. If the "slat adjusting time" is selected longer than the complete travelling time of the drive, a pushbutton function is possible as well. This means that the drive is active only when a button connected to the input is kept depressed.
- If the button is kept depressed longer than T1, the input transmits no further telegram. The drive remains on until the end position is reached.

Edge evaluation

The parameter "Command on rising edge" on the parameter page "Input x" (x = 1..8) specifies the direction of movement of the short time or long time telegram. In the "TOGGLE" setting (single-area operation) the input switches the direction of the short and long time telegram each time there is a new signal. Several short time telegrams in succession have the same direction.

- i** If the actuator is to be controlled from several locations, a faultless single-area operation requires that the all long time objects of the sensor devices are interlinked. A sensor device would otherwise not be able to detect that the actuator has been addressed from another sensor, in which case it would have to be actuated twice during the next use in order to produce the desired reaction.

Debounce time

The debounce time of the signal is defined by the device software via the parameter "Debounce time". The debounce time is defined for the functions of the binary input, after which actuation period the binary inputs identify a valid actuation of the connected contacts. In this way, it is possible to prevent the device from mistakenly identifying short conduction faults as a signal. The debounce time makes it possible to adapt the signal evaluation to the contact quality of the connected switches or push-buttons as well. The debounce time must be increased in the ETS if undesirable signal evaluations with very fast edge changes occur regularly or sporadically resulting in rapidly changing states of the KNX telegrams.

Response to bus voltage return

After a device reset (bus voltage return or ETS programming operation), the communication object "Long-time operation" of the input can be initialised. For this, the "Behaviour on bus voltage return" parameter should be configured to the required reaction. In the settings "Up" or "Down", telegrams are transmitted actively to the bus.

If, in the ETS, a delay is set for the inputs after bus voltage return, the device only transmits the telegrams when the delay has elapsed.

After a device reset, the "Short-time operation" object is always initialised with "0".

4.2.4.3.4 Value transmitter / Light scene extension

With the value transmitter functions "Dimming value transmitter", "Light scene extension without storage function", "Light scene extension with storage function", "Temperature value transmitter" and "Brightness value transmitter", the ETS either displays 1-byte object or a 2-byte object.

The data format of the value object is dependent on the set function of the value transmitter. The "Function input" parameter on the parameter page "Input" defines the function on one of the following value transmitter applications:

- Dimming value transmitter (1-byte),
- Light scene extension without memory function (1-byte),
- Light scene extension with memory function (1-byte).
- Temperature value transmitter (2-bytes),
- Brightness value transmitter (2-bytes),

Debounce time

The "Debounce time" parameter is available irrespective of the selected value transmitter function. It defines the signal debounce time through the device software. The debounce time is defined for the functions of the binary input, after which actuation period the binary inputs identify a valid actuation of the connected contacts. In this way, it is possible to prevent the device from mistakenly identifying short conduction faults as a signal. The debounce time makes it possible to adapt the signal evaluation to the contact quality of the connected switches or push-buttons as well. The debounce time must be increased in the ETS if undesirable signal evaluations with very fast edge changes occur regularly or sporadically resulting in rapidly changing states of the KNX telegrams.

The dimming value transmitter, temperature and brightness value transmitter different in data format and in the range of values. The independent function of the light scene extension is special and is described below.

Dimming value transmitter, temperature and brightness value transmitter

In the function as a dimming value transmitter, the input can transmitted unformatted integers in the range 0 ... 255 to the KNX. As a brightness value transmitter, the input transmits formatted floating point values in the range 0 ... 1500 Lux and, as a temperature value transmitter, in the range 0 ... 40 °C. Table 1 shows a summary of the value ranges of the value encoders. The values to be transmitted are configured in the ETS and can be adjusted later during device operation (see value adjustment below).

The edge evaluation of the device means that it can transmit values only on a rising edge, only on a falling edge or on a rising and falling edge. In this way, it is possible to make adjustments to the contact connected at the input (push-button as NC contact or NO contact and switch).

Value transmitter type	Function	Lower numerical limit	Upper numerical limit
Dimming value transmitter	0 ... 255	0	255
Temperature value transmitter	Temperature value	0 °C	40 °C
Brightness value transmitter	Brightness value	0 lux	1.500 lux

Table 1: Value ranges of dimming value transmitter, temperature and brightness value transmitter

Value adjustment for dimming value transmitter, temperature and brightness value transmitter

With the dimming value transmitter and the temperature and brightness value transmitter, the value to be transmitted can be adjusted at any time during device operation. A value adjustment can only be configurable in the ETS when the value is to be transmitted only on a rising edge or only on a falling edge, i.e. a push-button is connected to the input.

A value adjustment is introduced by a long signal at the input (> 5 s) and continues for as long

as the signal is detected as active, i.e. the push-button is actuated. With the first adjustment after commissioning, the value programmed by the ETS is increased cyclically by the step width configured for the dimming value transmitter and transmitted. The step width of the temperature value transmitter (1 °C) and the brightness value transmitter (50 Lux) is permanently defined. The previously transmitted value is saved after releasing the pushbutton. The next long pushbutton actuation adjusts the saved value and the direction of the value adjustment changes.

The time between two telegrams on adjusting values can be configured in the ETS.

Example of value adjustment (Figure 18):

- Function as dimming value transmitter
- Transmit value on = Rising edge
- Value configured in the ETS for rising edge = 17
- Step width = 5

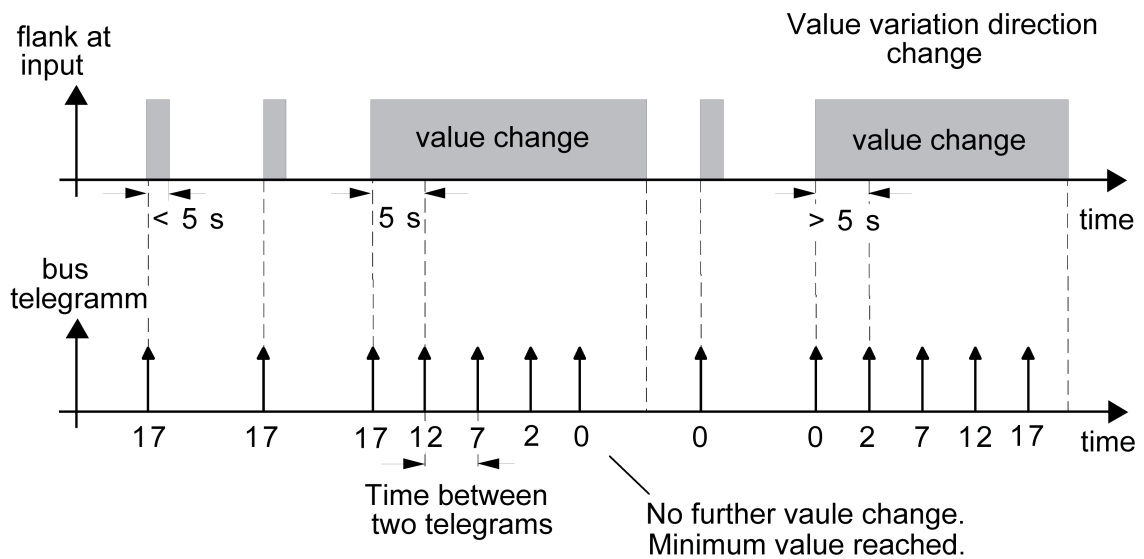

Figure 18: Example to change the value for dimming value transmitter

- i** There is no value over- or underrun on adjustment. If, during an adjustment, the maximum or minimum value is reached (see Table 1), no more telegrams are transmitted.
- i** To ensure that, during a value adjustment, for example the controlled lighting switches off or switches on at the maximum, the limit values (e.g. the values "0" or "255") are always transmitted when the limits of the adjustable range are reached. This also takes place when the configured step width of these values is not immediately taken into account (see example above: step width = 5; value "2" is transmitted, then value "0").
In this case, to ensure that the original starting value can be reset on resetting with a change to the adjustment direction, the first value jump is not equal to the preset step width (see example above: step width = 5; value "0" is transmitted, then values "2"; "7" etc.).
- i** The newly adjusted values are stored in RAM. After a device reset (bus voltage failure or ETS programming operation), the adjusted values are replaced by the values originally configured in the ETS.

Light scene extension

With a configuration as a light scene extension without a memory function, it is possible to recall a light scene, which is stored in an external KNX subscriber (e.g. light scene pushbutton sensor) With a rising, falling or rising and falling edge, the light scene number configured in the ETS is immediately transmitted to the KNX.

With a configuration as a light scene extension with a memory function, it is possible to generate a memory telegram according to the light scene to be transmitted. For this, the appropriate

memory telegram is transmitted for a long signal according to the configured edge evaluation (push-button as NC contact or NO contact - not as switch!). In this case, the time for long actuation can be configured (but not to below 5 s). With short actuation < 1 s, the configured light scene number (without memory telegram) is transmitted. If the actuation last longer than 1 s but less than 5 s, no telegram is triggered.

In addition, there is the option of only transmitting a memory telegram without prior light scene recall. In this case, the parameter "Only memory function ?" must be set to "Yes".

Examples for a light scene extension with memory function (Figure 19):

- 1.) Only memory function = No
- 2.) Only memory function = Yes

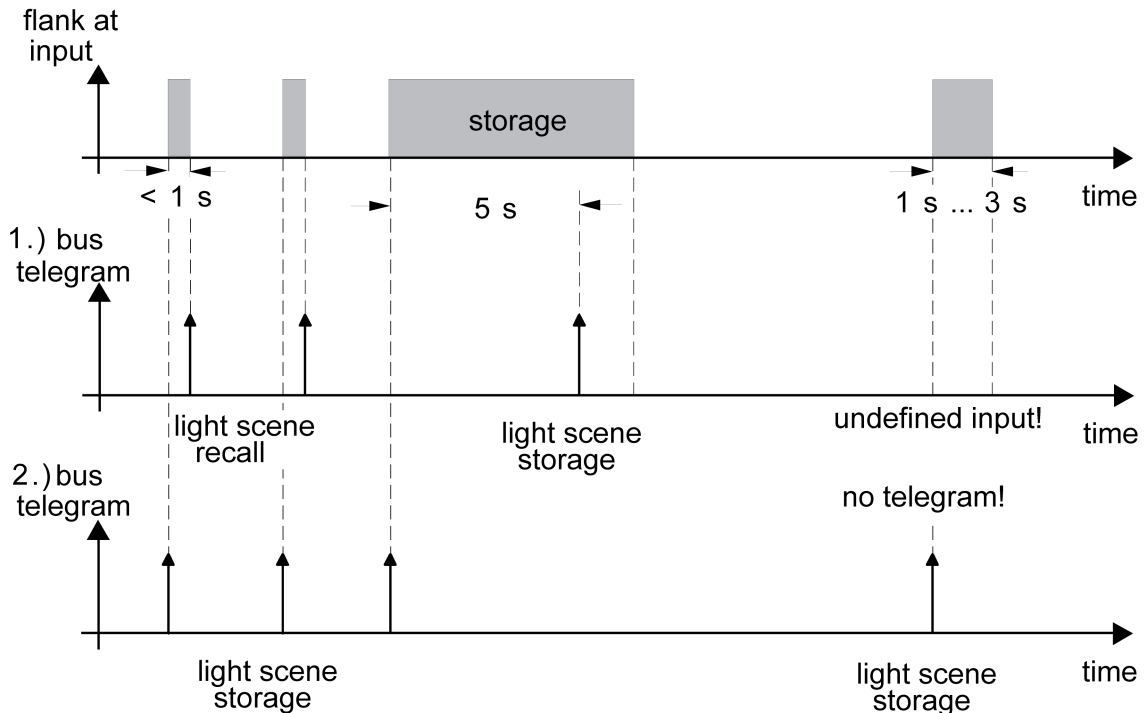

Figure 19: Example of scene storage

"Only memory function = No":

If a rising or falling edge is detected at the input (according to the configuration), the time recording operation begins. If actuation ceases during the first second, the appropriate light scene recall takes place immediately. If the signal length is longer, then the memory telegram is transmitted after 5 s.

"Only memory function = Yes":

The memory telegram is transmitted immediately after detection of the appropriate signal edge.

Behaviour on bus voltage return for value transmitter and light scene extension

After a device reset (bus voltage return or ETS programming operation), the communication object of the value transmitter or light scene extension can be initialised. For this, the "Behaviour on bus voltage return" parameter should be configured to the required reaction. The setting is dependent on the value transmitter function and edge evaluation selected in the ETS. In the settings "Reaction as rising edge" or "Reaction as falling edge", telegrams are transmitted actively to the bus according to the configuration in the ETS. In the "Transmit current input status" setting, the device evaluates the static signal status of the input and, according to this, transmits the appropriately configured telegram to the bus (contact closed at the input = telegram as with rising edge; contact open at input = telegram as with falling edge). This setting can only be configured with "Transmit value on = rising and falling edge (switch)".

If, in the ETS, a delay is set for the inputs after bus voltage return, the device only transmits the telegrams when the delay has elapsed.

4.2.4.3.5 Disabling function of the input

The input can be disabled separately via the KNX using 1-bit objects, if it set to the function "Switching", "Dimming", "Venetian blind" or "Value transmitter". With the "Switching" function, it is possible to disable the two switching objects of an input independently of each other. With an active disabling function, signal edges at the input are ignored by the device related to the affected objects.

Each input or each switching object can execute a specific independent reaction at the beginning or end of a disable. This reaction is specified on the parameter page "Disable" in the ETS and is dependent on the edge evaluation defined for the affected input. In so doing, it is possible to configure to "No reaction". Only in this case are dimming or Venetian blind control operations or value adjustments completed during an active disable and only then the input locked. In all other cases, the configured disabling command is executed immediately at the beginning of disabling.

In the "Transmit current input status" setting, the device evaluates the actual static signal status of the input and, according to this, transmits the appropriately configured telegram to the bus (contact closed at the input = telegram as with rising edge; contact open at input = telegram as with falling edge).

A disabling function is activated or deactivated by the corresponding 1-bit object. The telegram polarity can be set in the ETS for each disabling object. The disabling object is always inactive after a device reset. Even with an inverted polarity "Disabling = 0 (Enabling = 1)", a "0" telegram must first be received after a reset until the appropriate disabling function is activated.

- i Updates to disabling objects with the same telegram polarity (disabling -> disabling or enabling -> enabling) do not show a reaction.
- i With cyclical transmission in the "Switching" function: during an active disable, cyclical transmission does not take place via the disabled input switching object. Cyclical transmission is continued immediately at the end of the disabling with the last object value written to the object, provided that the transmission criterion for cyclical transmission is fulfilled ("transmit on ON, on OFF" or "on ON and OFF").

4.2.4.3.6 Remote sensor

A remote sensor for temperature measurement can be connected to the device..

With the input function "Remote sensor", the ETS displays two 2-byte communication objects. Via these two communication objects, the measured values of the remote sensor can be sent to the KNX in uncalibrated or calibrated form.

The remote sensor can be integrated into the room temperature measurement (see chapter 4.2.4.4. Room temperature measurement).

i Only as of application program version "1.2" the objects "T.Remote sensor" are always visible as soon as the parameter "Function input" is set to "Remote sensor", independent of the temperature detection of the room temperature measurement.

Using the input parameters on the parameter page "Input" the "Remote sensor" function can be configured as follows:

- Adjustment of the measured temperature value of the remote sensor (see page 82-83).
- Definition of a temperature change in K at which the temperature value is transmitted to the KNX.
- Setting of the behaviour on bus voltage return.
- Settings for cyclical transmission of measured values.

4.2.4.3.7 Temperature limit

A temperature sensor for temperature measurement can be connected to the device..

If the input executes the function "Temperature limiter, underfloor heating", then the device measures the temperature via the temperature sensor connected at the input. The measured temperature value can be calibrated on the parameter page "Room temperature measurement" (parameter "Calibration of temperature limiter"). The device executes the function "Underfloor heating temperature limiting" with the calibrated temperature value. The temperature value can be transmitted to the KNX via the "Floor temperature" output object.

If the input does not work as "Temperature limiter, underfloor heating", then a valid temperature must be specified for the device via the input object "Floor temperature". The device executes the function "Underfloor heating temperature limiting" with the received temperature value.

The function "Underfloor heating temperature limiting" is configured on the parameter page "Controller functionality".

- i The function is only effective if the parameter "Underfloor heating temperature limiting" on the parameter page "Controller functionality" is set to "Available".

4.2.4.4 Room temperature measurement

Basic principles

In order to ensure a fault-free and effective room temperature control, it is very important to determine the exact actual temperature.

The device possesses an integrated temperature sensor, using which the room temperature can be detected. Alternatively (e.g. if the device has been mounted in an unfavourable location) or in addition (e.g. in large rooms or halls), a remote sensor connected at the input or a temperature sensor linked via KNX telegrams can be used to determine the actual value for temperature measurement.

When choosing the installation location of the controller or the external sensors, the following points should be considered...

- Do not install temperature sensors in the area of large electrical consumers (avoid heat influences).
- Do not mount the temperature sensor near radiators or cooling systems.
- The temperature sensor should not be exposed to direct sun.
- The installation of sensors on the inside of an outside wall might have a negative impact on the temperature measurement.
- Temperature sensors should be installed at least 30 cm away from doors, windows or ventilation units and at least 1.5 m above the floor.

i Room temperature measurement by the device is independent of the "Room temperature control" function and can thus be used independently (e.g. for simple measurement and display of a room temperature without control).

i With regard to the mounting location of the device (e.g. near radiators, etc.), the internal temperature sensor of the device is not ideally suited for detection of the actual temperature required for room temperature control. If possible, the room temperature should be measured using a remote sensor or a received temperature value.

Temperature detection and measured value formation

The "Temperature detection" parameter in the "Room temperature measurement" parameter node specifies the sensors that are used to detect the room temperature. The following settings are possible for temperature detection

- "internal temperature sensor"
The temperature sensor integrated in the room temperature controller is activated. Thus, the actual temperature value is determined only locally on the device. In this configuration, the feedback control will start directly after a device reset.
- "Remote sensor"
The actual temperature is determined solely via the remote sensor connected to the input. Its measured temperature value can be transmitted to the KNX or read out, in uncalibrated or calibrated form, via 2-byte communication objects. The calibrated temperature value is used for room temperature control. The measured temperature value is automatically sent when a change is made to a configurable temperature value (parameter "Transmit on temperature change by"). In this configuration, the feedback control will start directly after a device reset. The precondition for this is that a remote sensor is connected and that it was also configured as a function on the "Input" parameter page.

- "received temperature value"
The actual temperature is determined solely via a temperature value received from the KNX. In this case, the sensor must either be a KNX room thermostat coupled via the 2-byte object "Received temperature" or a controller extension with temperature detection. The room temperature controller can request the current temperature value cyclically. For this purpose, the parameter "Request time for the received temperature value" must be set to a value > "0". The request interval can be configured within the limits of 1 minute to 255 minutes.
After a device reset the room temperature controller will first wait for a valid temperature telegram until the feedback control starts and a command value, if applicable, is output.

- "Internal sensor and remote sensor"
"Internal sensor and received temperature value"
"Remote sensor and received temperature value"
These settings are used to combine the selected temperature sources. The sensors can be either a remote sensor directly connected to the controller, or KNX room thermostats connected via the 2-byte object "Received temperature", or controller extensions with temperature detection.
With the setting "Received temperature value" the room temperature controller can request the current temperature value cyclically. For this purpose, the parameter "Request time of the received temperature value" must be set to a value > "0". The request interval can be configured within the limits of 1 minute to 255 minutes.
When using the remote sensor, its isolated measured temperature value can be transmitted to the KNX or read out, in uncalibrated or calibrated form, via 2-byte communication objects. After a device reset the room temperature controller will first wait for a valid temperature telegram until the feedback control starts and a command value, if applicable, is output.

When evaluating, the real actual temperature is made up from the two respective measured temperature values. The weighting of the temperature values is defined by the "Measured value formation..." parameter. Depending on the different locations of the sensors or a possible non-uniform heat distribution inside the room, it is thus possible to adjust the actual temperature measurement. Often, those temperature sensors that are subject to negative external influences (for example, unfavourable location because of exposure to sun or heater or door / window directly next to it) are weighted less heavily.

Example: The device (room temperature controller is activated) is installed close to an outer wall (internal sensor). An additional remote sensor has been mounted on an inner wall in the middle of the room below the ceiling.

Internal sensor: 21.5 °C

Received temperature: 22.3 °C

Determination of measured value: 30 % to 70 %

$$\begin{aligned} \rightarrow T_{\text{Result internal}} &= T_{\text{internal}} \cdot 0.3 = 6.45 \text{ °C}, \\ \rightarrow T_{\text{Result external}} &= T_{\text{external}} = 22.3 \text{ °C} \cdot 0.7 = 15.61 \text{ °C} \\ \rightarrow T_{\text{Result actual}} &= T_{\text{Result internal}} + T_{\text{Result external}} = \underline{\underline{22.06 \text{ °C}}} \end{aligned}$$

Calibrating the measured values

In some cases during room temperature measurement, it may be necessary to adjust the temperature values of the internal, the external sensor (received temperature value) or the remote sensor. Adjustment becomes necessary, for example, if the temperature measured by the sensors stays permanently below or above the actual temperature in the vicinity of the sensor. To determine the temperature deviation, the actual room temperature should be detected with a reference measurement using a calibrated temperature measuring device. The parameters "Internal sensor calibration" and/or "Calibration of remote sensor" and/or "Calibration of received temperature value" can configure the positive (temperature increase, factors: 1 ... 127) or negative (temperature decrease, factors -128... -1) temperature calibration in levels of 0.1 K. Thus, the calibration is made only once statically and is the same for all operating modes of the controller.

- i** The measured value has to be increased, if the value measured by the sensor lies below the actual room temperature. The measured value has to be decreased, if the value measured by the sensor lies above the actual room temperature.
- i** During room temperature control, the controller always uses the adjusted temperature value to calculate the command values. The calibrated temperature value is transmitted to the bus via the "Measured value" object (see also "Transmission of the measured value"). When determining the measured value using the internal and external sensor, the two calibrated values are used to calculate the actual value. Temporarily necessary, the uncalibrated room temperature of the internal temperature sensor can additionally be transmitted to the KNX as information (object "Measured value, uncalibrated") and, for example, be evaluated in other KNX devices or displayed in visualisations.
- i** The temperature calibration only affects room temperature measurement.

Transmission of the actual temperature

The determined temperature can be actively transmitted to the KNX via the 2-byte "Actual temperature" object. The parameter "Transmit at actual temperature change of..." specifies the temperature value by which the actual value has to change in order to have the actual temperature value transmitted automatically via the object. Possible temperature value changes lie within a range of 0.1 K and 25.5 K. If "0" is selected, the automatic transmission of the measured room temperature is deactivated.

In addition, the room temperature can be transmitted cyclically. The "Cyclical transmission of the actual temperature" parameter determines the cycle time (1 to 255 minutes). The value "0" will deactivate the periodical transmission of the temperature value. Setting the "Read" flag on the "actual temperature" object makes it possible to read out the current temperature value at any time over the KNX. It has to be pointed out that, with deactivated periodical transmission and deactivated automatic transmission, no more measured room temperature telegrams will be transmitted in case of a change.

Following the return of bus voltage or after programming via the ETS, the object value will be updated according to the actual temperature value and transmitted to the KNX. In case a temperature value telegram has not been received from the external sensor via the object "Received temperature" when evaluating an external temperature sensor, only the value measured by the internal sensor or by the remote sensor will be transmitted. If only the received temperature value is used, then the value "0" is located in the "Actual temperature" object after a reset until a valid temperature is received via the KNX. For this reason, the external temperature sensor should always transmit the current value after a reset.

During room temperature control, the controller always uses the adjusted temperature value to calculate the command values. The adjusted temperature value is transmitted to the KNX via the "Actual temperature" object. If necessary, the uncalibrated temperature values of the internal sensor, the remote sensor or the received temperature can additionally be transmitted as information to the KNX via the object "Measured value, uncalibrated" and, for example, be displayed in visualisations. The object for the unadjusted temperature is updated and transmitted at the same times as the "Actual temperature" object. The actual temperature is always the calibrated temperature.

Underfloor heating temperature limit

The temperature limit can be activated in the controller in order to protect an underfloor heating system. If the temperature limit is enabled in the ETS, the controller continuously monitors the floor temperature, either via remote sensors or via a received floor temperature. Should the floor temperature exceed a specific limiting value on heating, the controller immediately switches the

command value off, thus switching the heating off and cooling the system. Only when the temperature falls below the limiting value, minus a hysteresis of 1 K, will the controller add the most recently calculated command value.

In the ETS, the temperature limit can be activated by setting the "Underfloor heating temperature limit available" parameter in the "Room temperature control -> Controller functionality" parameter node to "Present".

- i** It should be noted that the temperature limit only affects command values for heating. Thus, the temperature limit requires the controller operating modes "Heating" or "Heating and cooling" (see chapter 4.2.4.5.1. Operating modes and operating mode change-over). The temperature limit cannot be configured in the operating mode "Cooling".

The temperature limit can also be used in a two-level feedback control with basic and additional levels. However, it must then be specified in the ETS to which level the limit shall apply. The limit can then either apply to the basic level or to the additional level for heating using the "Affects" parameter.

The underfloor heating temperature to be monitored can be fed into the controller via the KNX/EIB communication object "Floor temperature" or internally via a remote sensor (function input "Temperature limiter, underfloor heating"). As soon as the temperature limit is enabled in the ETS, the 2-byte object "Floor temperature" becomes visible. This object can be used to inform the controller of the current floor temperature using suitable temperature value telegrams from other KNX devices (e.g. analogue input with temperature sensor, etc.).

The maximum limit temperature, which the underfloor heating system may reach, is specified in the ETS using the "Maximum underfloor heating system temperature" parameter. The temperature can be set to a value between 20 and 70 °C. If this temperature is exceeded, the controller switches the underfloor heating system off using the command value. As soon as the floor temperature has fallen 1 K under the limit temperature, the controller switches the command value on again, assuming that this is intended in the control algorithm. The 1 K hysteresis is fixed and cannot be changed.

- i** Depending on the configuration, the temperature may have a strong impact on the controller behaviour. Poor parameterisation of the limit temperature (limit temperature near to the room/setpoint temperature) means that it is possible that the specified setpoint temperature for the room can never be reached!

4.2.4.5 Room temperature controller

The device can be used for single-room temperature control. Depending on the operating mode, current temperature setpoint and room temperature, command values for heating or cooling control and fan controller can be sent to the KNX. These command values are usually then converted by a suitable KNX actuator, e.g. heating or switching actuators or directly by bus-compatible actuating drives, evaluated and converted to physical variables for air conditioning control.

The room temperature control is an independent function section of the device. It has its own parameter and object range in the ETS configuration, which is enabled when room temperature measurement is enabled. Therefore, the room temperature controller can be switched on or off, irrespective of the valve drive or input function.

The controller function section of the device can be switched on as an option. This means that the control algorithm is active and the controller transmits command value telegrams.

The two function blocks "Valve drive" and "Room temperature controller" must be interconnected via group addresses, meaning that the command value transmitted by the internal controller can, for example, be directly converted by the valve drive of the device.

In this chapter, the functions of the room temperature controller are described.

4.2.4.5.1 Operating modes and operating mode change-over

Introduction

The room temperature controller distinguishes between two different operating modes. The operating modes specify whether you want the controller to use its variable to trigger heating systems ("heating" single operating mode) or cooling systems ("cooling" single operating mode). You can also activate mixed operation, with the controller being capable of changing over between "Heating" and "Cooling" either automatically or via a communication object. In addition, you can establish two-level control operation to control an additional heating or cooling unit. For two-level feedback control, separate command values will be calculated as a function of the temperature deviation between the setpoint and the actual value and transmitted to the bus for the basic and additional levels. The parameter "Operating mode" in the "Room temperature control -> Controller general" parameter branch specifies the operating mode and, if necessary, enables the additional level(s).

"Heating" or "cooling" single operating modes

In the single "Heating" or "Cooling" operating modes without any additional level, the controller will always work with one command value and, alternatively, when the additional level is enabled, it will use two command value in the configured operating mode. Depending on the determined room temperature and on the specified setpoint temperatures of the operating modes, (see chapter 4.2.4.5.4. Operating mode switch-over) the room temperature controller will automatically decide whether heating or cooling energy is required and calculates the command value for the heating or cooling system. The controller indicates whether it is currently heating or cooling by means of the objects "Heating message" or "Cooling message". If it is defined in the configuration that a basic and additional level are used, then the basis for the messages "Heating" and "Cooling" is the state that the basic level is currently in.

"Heating and cooling" mixed operating mode

In the "Heating and cooling" mixed operating mode, the controller is capable of triggering heating and cooling systems. In this connection, you can set the change-over behaviour of the operating modes...

- "Change over between heating and cooling" parameter in the "Room temperature control -> Controller general -> Setpoints" parameter branch set to "Automatic".
In this case, a heating or cooling mode will be automatically activated, depending on the room temperature determined and on the given temperature basic setpoint, or on the deadband, respectively. If the room temperature is within the preset deadband neither heating nor cooling will take place (both command values = "0"). If the room temperature is higher than the cooling temperature setpoint cooling will take place. If the room temperature is lower than the cooling temperature setpoint heating will take place.
When the heating/cooling operating mode is changed over automatically, the information can be actively sent to the bus via the object "Heating/cooling change-over" to indicate whether the controller is working in the heating mode ("1" telegram) or in the cooling mode ("0" telegram). In this connection, the "Automatic heating/cooling change-over transmission" parameter specifies when an operating mode change-over will be transmitted...
Setting "On changing the operating mode": in this case, a telegram will be transmitted solely on change-over from heating to cooling (object value = "0") or from cooling to heating (object value = "1"), respectively.
- Setting "On changing the output command value": with this setting, the current operating mode will be transmitted whenever there is a modification of the output command value. If the variable = "0" the operating mode which was active last will be transmitted. If the room temperature determined is within the dead band the operating mode activated last will be retained in the object until a switch-over into the other operating mode takes place, if necessary. In addition, the object value can be output in cycles when automatic switch-over is being made.
The "Cyclical transmission heating/cooling change-over" parameter enables cyclic transmission (factor > "0" setting) and specifies the cycle time.
With an automatic operating mode change-over, it should be noted that under certain circumstances there will be continuous change-over between heating and cooling if the deadband is too small. For this reason, you should, if possible, not set the deadband (temperature difference between the setpoint temperatures for the comfort heating and cooling modes) below the default value (2 K).

- "Change-over between heating and cooling" parameter in the "Room temperature control -> Controller general -> Setpoints" parameter branch set to "Via object".
In this case, the operating mode is controlled via the object "Heating/cooling change-over", irrespective of the deadband. This type of change-over can, for example, become necessary if both heating and cooling should be carried out through a one-pipe system (heating and cooling system). For this, the temperature of the medium in the single-pipe system must be changed via the system control. Afterwards the heating/cooling operating mode is set via the object (often the single-pipe system uses cold water for cooling during the summer, hot water for heating during the winter).
The "Heating/cooling change-over" object has the following polarities: "1": heating; "0" cooling. After a reset, the object value will be "0", and the "Heating/cooling operating mode change-over after reset" set in the ETS will be activated. You can use the "Heating/cooling operating mode after reset" parameter to set which mode you want to activate after a reset. For the "Heating" or "Cooling" settings, the controller will activate the configured heating/cooling operating mode immediately after the initialisation phase. In case of parameterisation "Operating mode before reset" the operating mode which was selected before the reset will be activated.
If a change-over is made through the object the operating mode will first be changed into the one specified to be activated after a reset. A change-over to the other operating mode will only take place after the device receives an object update, if necessary.
Notes on the setting "Operating mode before reset": frequent changing of the operating mode (e. g. several times a day) during running operation can adversely affect the life of the device as the read-only memory (EEPROM) used has been designed for less frequent write access events only.

It is not possible to heat and cool at the same time (command value > "0"). Only with PWM is it possible that a short-time 'command value overlapping' could occur during the transition between heating and cooling, due to the matching of the command value at the end of a time cycle. However, such overlapping will be corrected at the end of a PWM time cycle.

Heating/cooling message

Depending on the set operating mode, separate objects can be used to indicate whether the controller is currently demanding heating or cooling energy and is thus actively heating or cooling. As long as the heating command value is > "0", a "1" telegram will be transmitted through the "Heating" signal object. The signal telegram is only reset when the command value is "0" ("0" telegram is transmitted). The same applies to the signal object for cooling.

- i** It should be noted that with a 2-point feedback control the message objects for heating and cooling will already become active as soon as the temperature falls short of the temperature setpoint of the active operating mode in case of heating or exceeds the temperature setpoint in case of cooling. In this case, the configured hysteresis is not taken into account.

The signal objects can be enabled by the "Heating message" or "Cooling message" parameters in the "Room temperature control -> Command value and status output" parameter branch. The control algorithm controls the signal objects. Please note that the command value is recalculated every 30 s, followed by an updating of the signal objects.

4.2.4.5.2 Control algorithms and calculation of command values

Introduction

To facilitate convenient temperature control in living or business spaces a specific control algorithm which controls the installed heating or cooling systems is required. Taking account of the preset temperature setpoints and the actual room temperature, the controller thus determines command values which trigger the heating or the cooling system. The control system (control circuit) consists of a room temperature controller, an actuator or switching actuator (when ETD electrothermal drives are used), the actual heating or cooling element (e. g. radiator or cooling ceiling) and of the room. This results in a controlled system (Figure 20).

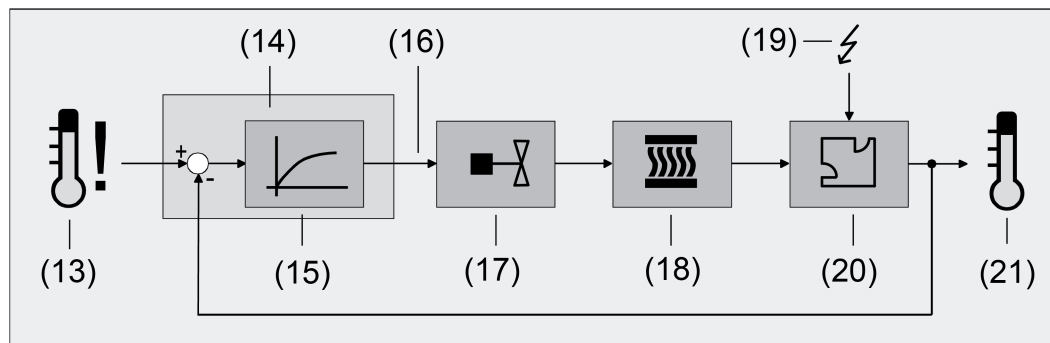

Figure 20: Controlled system of single-room temperature control

- (13) Setpoint temperature specification
- (14) Room temperature controller
- (15) Control algorithm
- (16) Command value
- (17) Valve control (actuating drive, ETD, heating actuator, ...)
- (18) Heat / cold exchanger (radiator, cooling ceiling, FanCoil, ...)
- (19) Fault variable (sunlight penetration, outdoor temperature, illumination systems, ...)
- (20) Room
- (21) Actual temperature (room temperature)

The controller measures the actual temperature (21) and compares it with the given setpoint temperature (13). With the aid of the selected control algorithm (15), the command value (16) is then calculated from the difference between the actual and the setpoint temperature. The command value controls valves or fans for heating or cooling systems (17), meaning that heating or cooling energy in the heat or cold exchangers (18) is passed into the room (20). Regular readjustment of the command value means that the controller is able to compensate for setpoint / actual temperature differences caused by external influences (19) in the control circuit. In addition, the flow temperature of the heating or cooling circuit influences the control system which necessitates adaptations of the variable.

The room temperature controller facilitates either proportional/integral (PI) feedback control as a continuously working or switching option, or, alternatively, switching 2-point feedback control. In some practical cases, it can become necessary to use more than one control algorithm. For example, in bigger systems using floor heating, one control circuit which solely activates the underfloor heating can be used to keep the latter at a constant temperature. The radiators on the wall, and possibly even in a side area of the room, will be controlled separately by an additional level with its own control algorithm. In such cases, distinction must be made between the different types of control, as floor heating systems, in most cases, require control parameters which are different to those of radiators on the wall, for example. It is possible to

configure up to four independent control algorithms in two-level heating and cooling operation.

The command values calculated by the control algorithm are output via the "Heating command value" or "Cooling command value" communication objects. Depending on the control algorithm selected for the heating and/or cooling mode, the format of the command value objects is, among other things, also specified. In this way, 1-bit or 1-byte actuating objects can be created. The control algorithm is specified by the parameters "Type of heating control" or "Type of cooling control" in the "Room temperature control -> Controller general" parameter branch and, if necessary, also with a distinction of the basic and additional stages.

Continuous PI control

PI control is an algorithm which consists of a proportional part and an integral part. Through the combination of these control properties, you can obtain room temperature control as quickly and precisely as possible without or only with low deviations. When you use this algorithm, the room temperature controller will calculate a new continuous command value in cycles of 30 seconds and send it to the bus via a 1-byte value object if the calculated command value has changed by a specified percentage. You can use the "Automatic transmission on change by..." parameter in the "Room temperature control -> Command value and status output" parameter branch to set the change interval in percent.

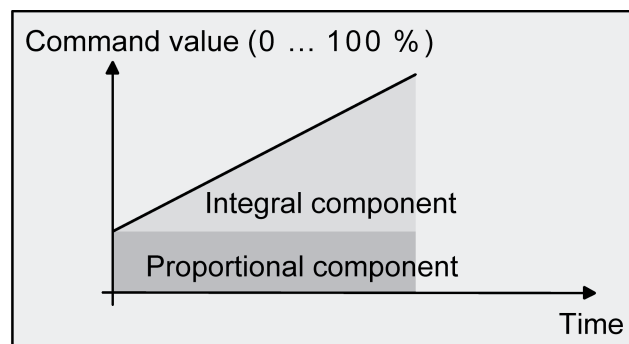

Figure 21: Continuous PI control

An additional heating or cooling level as PI control works in the same way as the PI control of the basic level, with the exception that the setpoint will shift, taking account of the configured level width.

Switching PI control

With this type of feedback control, the room temperature will also be kept constant by the PI control algorithm. Taking the mean value for a given time, the same behaviour of the control system will result as you would obtain with a continuous controller. The difference compared with continuous feedback control is only the way how the command value is output. The command value calculated by the algorithm in cycles of every 30 seconds is internally converted into a pulse-width-modulated (PWM) command value signal and sent to the bus via a 1-bit switching object after the cycle time has elapsed. The mean value of the command value signal resulting from this modulation is a measure for the averaged position of the control valve, thus being a reference to the room temperature set, taking account of the cycle time which you can set through the "Cycle time of the switching command value..." parameter in the "Room temperature control -> Command value and status output" parameter branch. A shift of the mean value, and thus a change in the heating capacity, can be obtained by

changing the duty factor of the switch-on and switch-off pulses of the command value signal. The duty factor will be adapted by the regulator only at the end of a time period, depending on the variable calculated. This applies to any change of the command value, regardless of what the ratio is by which the command value changes (the "Automatic transmission on change by..." and "Cycle time for automatic transmission..." parameters will have no function in this case). Each command value calculated last during an active time period will be converted. Even after you have changed the setpoint temperature, for example, by switching over the operating mode, the command value will still be adapted after the end of an active cycle time. The diagram below shows the command value switching signal output according to the internally calculated command value (first of all, a command value of 30 %, then of 50 %, with the command value output not being inverted).

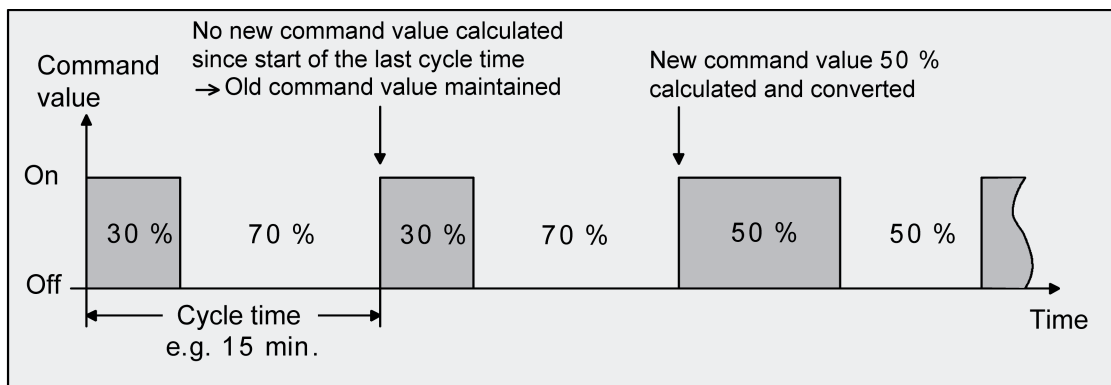

Figure 22: Switching PI control

For a command value of 0 % (permanently off) or of 100 % (permanently on), a command value telegram corresponding to the command value ("0" or "1") will always be sent after a cycle time has elapsed.

For switching PI control, the controller will always use continuous command values for internal calculation. Such continuous values can additionally be sent to the bus via a separate 1-byte value object, for example, as status information for visualisation purposes (if necessary, also separately for the additional levels). The status value objects will be updated at the same time as the command value is output and will only take place after the configured cycle time has elapsed. The parameters "automatic transmission on change by..." and "Cycle time for automatic transmission..." parameters will have no function in this case. An additional heating or cooling level as switching PI control works in the same way as the PI control of the basic stage, with the exception that the setpoint will shift, taking account of the configured level width. All PWM control options will use the same cycle time.

Cycle time:

The pulse-width-modulated command values are mainly used for activating electrothermal drives (ETD). In this connection, the room temperature controller sends the switching command values telegrams to a switching actuator equipped with semiconductor switching elements which the drives are connected to (e.g. heating actuator or room actuator). By setting the cycle time of the PWM signal on the controller, you can adapt the feedback control to the drives used. The cycle time sets the switching frequency of the PWM signal and allows adaptation to the adjusting cycle times of the actuators used (the adjusting time it takes the drive to bring the valve from its completely closed to its completely opened position). In addition to the adjusting cycle time, take account of the dead time (the time in which the actuators do not show any response when being switched or off). If different actuators with different adjusting cycle times are used, take account of the longest of the times. Always note the information given by the manufacturers of the actuators.

During cycle time configuration, a distinction can always be made between two cases...

Case 1: Cycle time > 2 x adjusting cycle time of the electrothermal drives used (ETA)

In this case, the switch-on or switch-off times of the PWM signal are long enough for the actuators to have sufficient time to fully open or fully close within a given time period.

Advantages:

The desired mean value for the command value and thus for the required room temperature will be set relatively precisely, even for several actuators triggered at the same time.

Disadvantages:

It should be noted, that, due to the full valve lift to be continuously 'swept', the life expectancy of the actuators can diminish. For very long cycle times (> 15 minutes) with less sluggishness in the system, the heat emission into the room, for example, in the vicinity of the radiators, can possibly be non-uniform and be found disturbing.

- i** This setting is recommended for sluggish heating systems (such as underfloor heating).
- i** Even for a bigger number of triggered actuators, maybe of different types, this setting can be recommended to be able to obtain a better mean value of the adjusting travels of the valves.

Case 2: Cycle time < adjusting cycle time of the electrothermal drives used (ETA)

In this case, the switch-on or switch-off times of the PWM signal are too short for the actuators to have enough time to fully open or fully close within a given period.

Advantages:

This setting ensures continuous water flow through the radiators, thus facilitating uniform heat emission into the room.

If only one actuator is triggered the regulator can continuously adapt the variable to compensate the mean value shift caused by the short cycle time, thus setting the desired room temperature.

Disadvantages:

If more than one drive is triggered at the same time the desired mean value will become the command value, which will result in a very poor adjustment of the required room temperature, or in adjustment of the latter with major deviations, respectively.

The continuous flow of water through the valve, and thus the continuous heating of the drives causes changes to the dead times of the drives during the opening and closing phase. The short cycle time and the dead times means that the required variable (mean value) is only set with a possibly large deviation. For the room temperature to be regulated constantly after a set time, the controller must continually adjust the command value to compensate for the mean value shift caused by the short cycle time. Usually, the control algorithm implemented in the controller (PI control) ensures that control deviations are compensated.

- i** This setting is recommended for quick-reaction heating systems (such as surface radiators).

Switching 2-point feedback control

The switching 2-point control represents a very simple type of temperature control. For this type of feedback control, two hysteresis temperature values are set. The actuators are triggered by the controller via switch-on and switch-off command value commands (1-bit type). A continuous variable is not calculated for this type of control.

The room temperature is also evaluated by this type of control in cycles every 30 seconds. Thus the command values change, if required, only at these times. The disadvantage of a continuously varying temperature as a result of this feedback control option is in contrast with

the advantage of this very simple 2-point room temperature control. For this reason, quick-reaction heating or cooling systems should not be triggered by a 2-point feedback control system, for this can lead to very high overshooting of the temperature, thus resulting in loss of comfort. When presetting the hysteresis limiting values, you should distinguish between the operating modes.

"Heating" or "cooling" single operating modes:

In heating mode, the controller will turn on the heating when the room temperature has fallen below a preset limit. In heating mode, the feedback control will only turn off the heating once a preset temperature limit has been exceeded.

In cooling mode, the controller will turn on the cooling system when the room temperature has exceeded a preset limit. The control system will only turn off the cooling system once the temperature has fallen below a preset limit. In this connection, the command value "1" or "0" will be output, depending on the switching status, if the temperature exceeds or falls below the hysteresis limits.

The hysteresis limits of both operating modes can be configured in the ETS.

- i** It has to be pointed out that the message objects for heating and cooling will already become active as soon as the temperature falls short of the temperature setpoint of the active operating mode in case of heating or exceeds the temperature setpoint in case of cooling. In this case the hysteresis is not being considered.

The following two images each show a 2-point feedback control for the individual operating modes "Heating" (Figure 23) or "Cooling" (Figure 24). The images take two temperature setpoints, one-stage heating or cooling and non-inverted command value output.

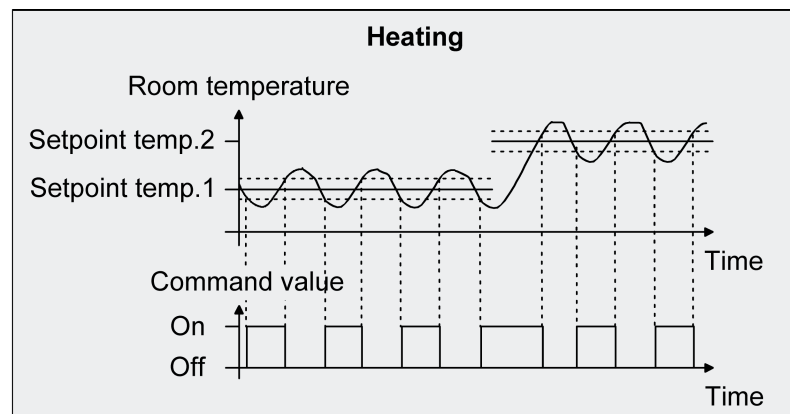

Figure 23: 2-point feedback control for the single "Heating" operating mode

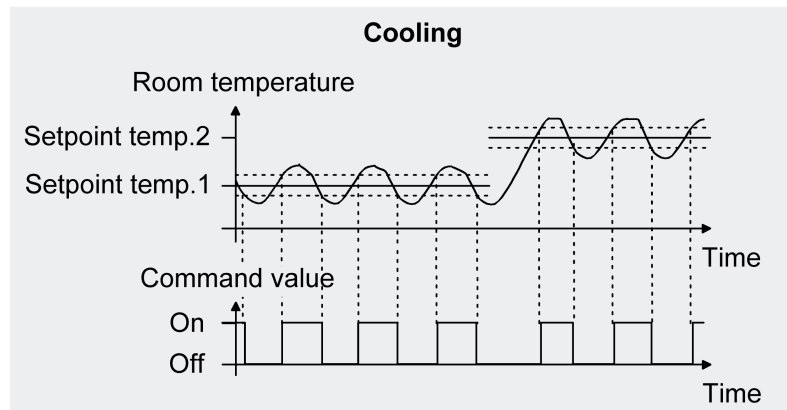

Figure 24: 2-point feedback control for the single "Cooling" operating mode

An additional 2-point feedback control heating or cooling level works exactly the same as the 2-point feedback control of the basic level. The difference is that the setpoint and the hysteresis values will shift by taking into account the configured level offset.

"Heating and cooling" mixed operating mode:

In mixed operation, a distinction is made whether the change-over between heating and cooling is to be effected automatically or in a controlled way through the object...

- With automatic operating mode change-over, in the heating mode the controller will turn on the heating when the room temperature has fallen below a preset hysteresis limit. In this case, as soon as the room temperature exceeds the setpoint of the current operating mode, the feedback control will turn off the heating in the heating mode. Similarly, in cooling mode, the controller will turn on the cooling system when the room temperature has exceeded a preset hysteresis limit. As soon as the room temperature falls below the setpoint of the current operating mode, the feedback control will turn off the cooling system in the cooling mode. Thus, in mixed operation, there is no upper hysteresis limit for heating or no lower one for cooling, respectively, for these values would be in the deadband. Within the deadband, neither heating nor cooling will take place.
 - With operating mode change-over via the object, in the heating mode, the controller will turn on the heating when the room temperature has fallen below a preset hysteresis limit. The feedback control will only turn off the heating in the heating mode once the preset upper hysteresis limit has been exceeded. Similarly, in cooling mode, the controller will turn on the cooling system when the room temperature has exceeded a preset hysteresis limit. The feedback control will only turn off the cooling system in the cooling mode once the temperature has fallen below the preset lower hysteresis limit. As with the individual operating modes of heating or cooling, there are two hysteresis limits per operating mode. Although there is a deadband for the calculation of the temperature setpoints for cooling, it has no influence of the calculation of the two-point control value, as the operating mode is switched over "manually" through the corresponding object. Within the hysteresis spans, it thus will be possible to request heating or cooling energy for temperature values that are located within the deadband.
- i** Also, with an automatic operating mode change-over, an upper hysteresis limiting value for heating and a lower hysteresis limiting value for cooling can be configured in the ETS for 2-point control, although they have no function.

The following two images show 2-point feedback control for the mixed operating mode "Heating and cooling", distinguishing between heating mode (Figure 25) and cooling mode (Figure 26). The images take two temperature setpoints, a non-inverted command value output and an automatic operating mode change-over. When the operating mode is changed-over via the object, an upper hysteresis for heating and a lower hysteresis for cooling and be configured.

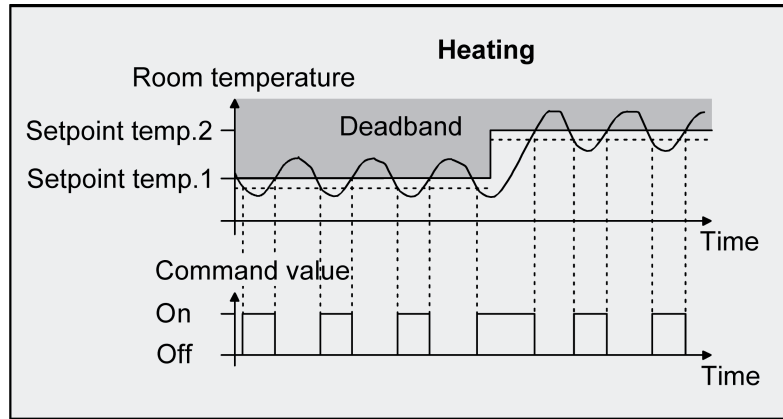

Figure 25: 2-point feedback control for mixed "Heating and cooling" mode with active heating mode.

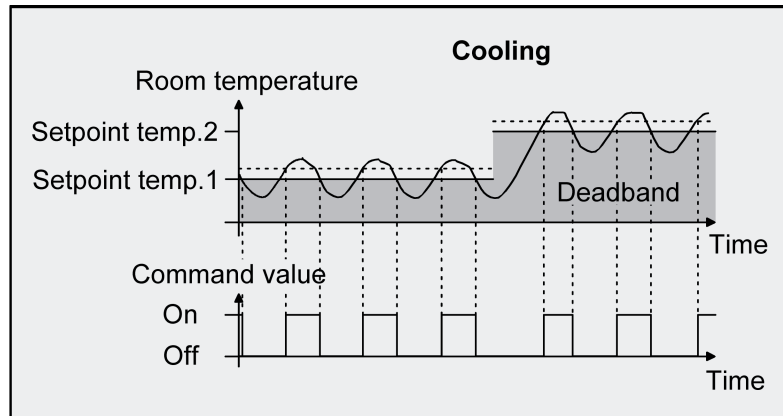

Figure 26: 2-point feedback control for mixed "Heating and cooling" mode with active cooling operation.

The command value "1" or "0" will be output, depending on the switching status, if the temperature exceeds or falls below the hysteresis limits or the setpoints.

- i** It has to be pointed out that the message objects for heating and cooling will already become active as soon as the temperature falls short of the temperature setpoint of the active operating mode in case of heating or exceeds the temperature setpoint in case of cooling. In this case the hysteresis is not being considered.

An additional 2-point feedback control heating or cooling level works exactly the same as the 2-point feedback control of the basic level. The difference is that the setpoint and the hysteresis values will shift by taking into account the configured level offset.

4.2.4.5.3 Adapting the control algorithms

Adapting the PI control

There are several systems available, which may heat or cool a room. One option is to uniformly heat or cool the surroundings via heat transfer media (preferably water or oil) in connection with room air convection. Such systems are used, for example, with wall mounted heaters, underfloor heating or cooling ceilings.

Alternatively or additionally forced air systems may heat or cool rooms. In most cases such systems are electrical forced hot air systems, forced cool air systems or refrigerating compressors with fan. Due to the direct heating of the room air such heating and cooling systems work quite swiftly.

The control parameters need to be adjusted so that the PI control algorithm may efficiently control all common heating and cooling systems thus making the room temperature control work as fast as possible and without deviation. Certain factors can be adjusted with a PI control that can influence the control behaviour quite significantly at times. For this reason, the room temperature controller can be set to predefined 'experience values' for the most common heating and cooling systems. In case the selection of a corresponding heating or cooling system does not yield a satisfactory result with the default values, the adaptation can optionally be optimised using control parameters.

Predefined control parameters for the heating or cooling stage and, if applicable, also for the additional stages are adjusted via the "type of heating" or "type of cooling" parameters. These fixed values correspond to the practical values of a properly planned and executed air conditioning system and will result in an ideal behaviour of the temperature control. The heating and cooling types shown in the following tables can be specified for heating and cooling operation.

Type of heating	Proportional range (preset)	Reset time (preset)	Recommended PI control type	Recommended PWM cycle time
Heat water heating	5 Kelvin	150 minutes	Continuous / PWM	15 min.
Underfloor heating	5 Kelvin	240 minutes	PWM	15-20 min.
Electrical heating	4 Kelvin	100 minutes	PWM	10-15 min.
Fan coil unit	4 Kelvin	90 minutes	Continuous	---
Split unit (split climate control unit)	4 Kelvin	90 minutes	PWM	10-15 min.

Table 3: Predefined control parameters and recommend control types for heating systems

Cooling type	Proportional range (preset)	Reset time (preset)	Recommended PI control type	Recommended PWM cycle time
Cooling ceiling	5 Kelvin	240 minutes	PWM	15-20 min.
Fan coil unit	4 Kelvin	90 minutes	Continuous	---
Split unit (split climate control unit)	4 Kelvin	90 minutes	PWM	10-15 min.

Table 4: Predefined control parameters and recommend control types for cooling systems

If the "Type of heating" or "Type of cooling" parameters are set to "Via control parameters" it will be possible to adjust the control parameter manually. The feedback control may be considerably influenced by presetting the proportional range for heating or for cooling (P component) and the reset time for heating or for cooling (I component).

- i** Even small adjustments of the control parameters will lead to noticeable different control behaviour.
- i** The adaptation should start with the control parameter setting for the corresponding heating or cooling system according to the fixed values mentioned in Tables 3 & 4.

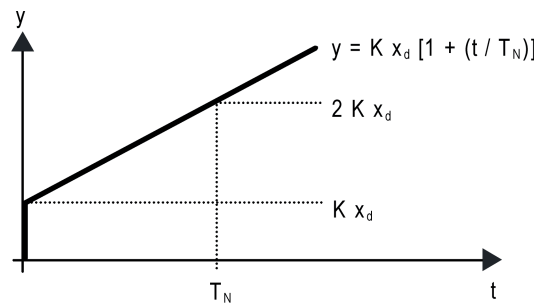

Figure 27: Function of the command value of a PI control

y: Command value
 x_d : Control difference ($x_d = x_{set} - x_{act}$)
 $P = 1/K$: Configurable proportional band
 $K = 1/P$: Gain factor
 T_N : Configurable reset time

PI control algorithm: Command value $y = K x_d [1 + (t / T_N)]$

Deactivation of the reset time (setting = "0") ->
 P control algorithm: Command value $y = K x_d$

Parameter setting	Effect
P: Small proportional range	Large overshoot in case of setpoint changes (possibly permanently), quick adjustment to the setpoint
P: Large proportional range	no (or small) overshooting but slow adjustment
T_N : Short reset time	Fast compensation of control deviations (ambient conditions), risk of permanent oscillations
T_N : Long reset time	Slow compensation of control deviations

Table 5: Effects of the settings for the control parameters

Adapting the 2-point feedback control

2-point feedback control represents a very simple temperature control. For this type of feedback control, two hysteresis temperature values are set. The upper and lower temperature hysteresis limits can be adjusted via parameters. It has to be considered that:

- A small hysteresis will lead to small temperature variations but to a higher bus load.
- A large hysteresis switches less frequently but will cause uncomfortable temperature variations.

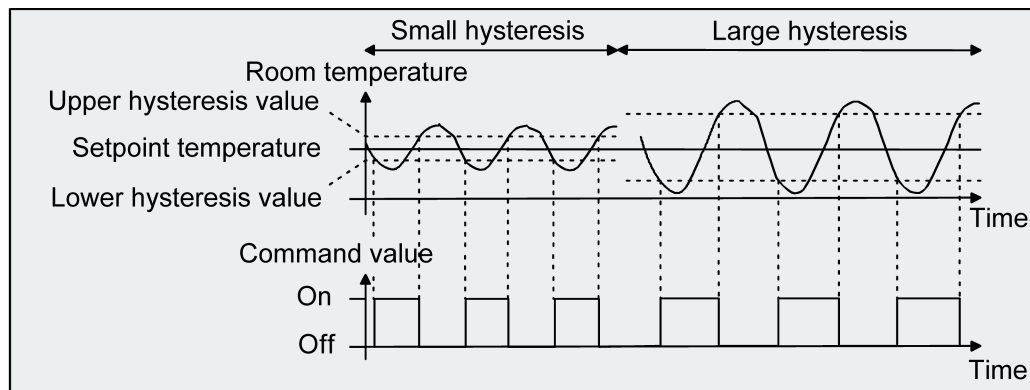

Figure 28: Effects of the hysteresis on the switching behaviour of the command value of 2-point feedback control

4.2.4.5.4 Operating mode switch-over

Introduction - The operating modes

The room temperature controller has various operating modes. The selection of these modes will, for example, facilitate the activation of different temperature setpoints, depending on the presence of a person, on the state of the heating or cooling system, on the time of the day, or on the day of the week. The following operating modes can be distinguished:

- Comfort mode

Comfort mode is usually activated if persons are in a room, and the room temperature should, for this reason, be adjusted to an adequately convenient value. In comfort mode, it is possible to change over via the objects "Operating mode change-over" or "Presence object", if the "Presence detection" is set to "Presence detector".

- Standby mode

If a room is not used during the day because persons are absent, you can activate the Standby mode. Thereby, you can adjust the room temperature on a standby value, thus to save heating or cooling energy, respectively.

- Night operation

During the night hours or during the absence of persons for a longer time, it mostly makes sense to adjust the room temperature to lower values for heating systems (e.g. in bedrooms). In this case, cooling system can be set to higher temperature values, if air conditioning is not required (e.g. in offices). For this purpose, you can activate the Night mode.

- Frost/heat protection mode

Frost protection will be required if, for example, the room temperature must not fall below critical values while the window is open. Heat protection can be required where the temperature rises too much in an environment which is always warm, mainly due to external influences. In such cases, you can activate the Frost/heat protection operating mode and prescribe some temperature setpoint of its own for either option, depending on whether "Heating" or "Cooling" has been selected, to prevent freezing or overheating of the room.

- Comfort extension (temporary Comfort mode)

You can activate the comfort extension from the night or frost/heat protection mode (not triggered by the "Window status" object) and use it to adjust the room temperature to a comfort value for some time if, for example, the room is also 'used' during the night hours. This mode can exclusively be activated by a presence button via the presence object. The comfort extension option will be automatically deactivated after a definable time has elapsed, or by pressing the presence button once more, or by receiving a presence object value = 0, respectively. You cannot retrigger this extension.

- i You can assign an own temperature setpoint to the "Heating" or "Cooling" operating modes for each operating mode.

Operating mode switch-over

You can activate or switch over the operating modes in various ways. Depending on one another in priority, activation or change-over is possible by:

- KNX communication objects separately available for each operating mode or alternatively through the 1-byte communication object "Operating mode change-over".

The following section describes the individual options for changing over the operating modes in more detail.

- i** The presence message, the window status and the forced object for operating mode change-over (see following sections) have a higher priority than the change-over of the operating mode via the individual objects ("Comfort mode", "Night mode", "Standby mode" and "Frost / heat protection") or via the 1-byte communication object "Operating mode change-over". Therefore, change-overs by evaluating the appropriate objects ("Presence object", "Window status" and "KNX Status Forced Operating Mode") have priority.

The operating modes can be activated or switched over by means of the 1-bit communication object available separately for each operating mode, or alternatively, by means of the KNX objects. In the last case, also through a controller extension.

An operating mode change-over can either take place via four 1-bit communication objects or via a 1-byte communication object. The "Operating mode change-over" parameter in the "Room temperature control -> Controller general" parameter branch specifies the switching method as follows...

- **Operating mode change-over "Via switching (4 x 1 bit)"**

There is a separate 1-bit change-over object for each operating mode. Each of these objects allows the current operating mode to be switched over or to be set, depending on the priority. Taking account of the priority, a specific change-over hierarchy will result from the operating mode change-over by the objects, a distinction being made between presence detection by the presence button or the presence(Figure 30)detector. In addition, the status of the window in the room can be evaluated using the "Window status" object, meaning that, when the window is open, the controller can switch to Frost/heat protection mode, irrespective of the set operating mode, in order to save energy . Table 5 also shows the status of the communication objects and the resulting operating mode.

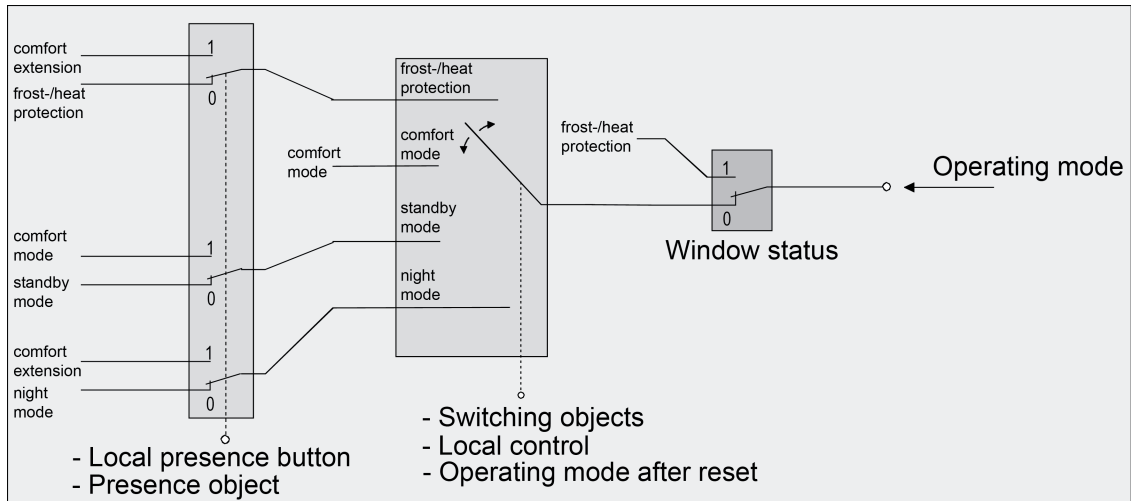

Figure 29: Operating mode change-over through 4 x 1-bit objects with presence button

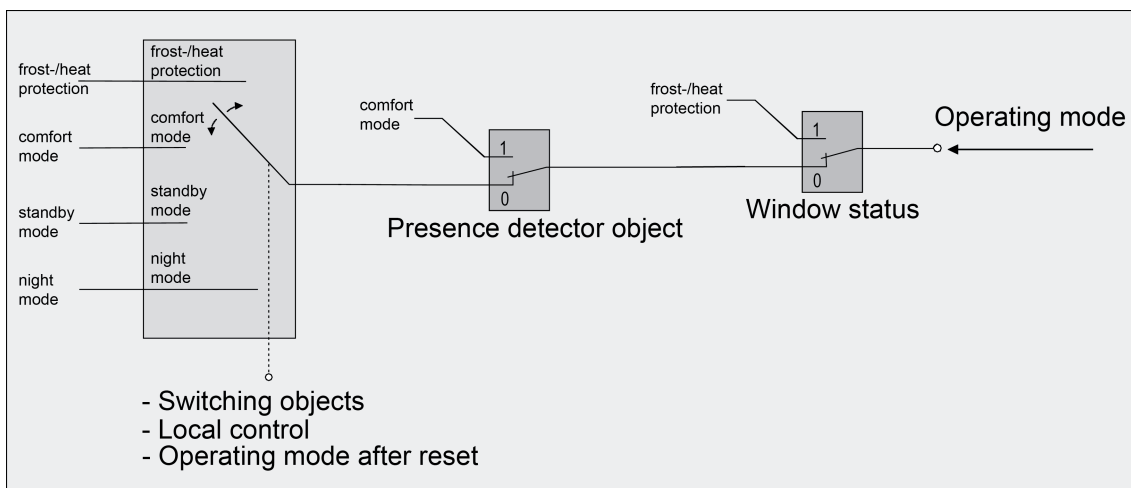

Figure 30: Operating mode change-over through 4 x 1-bit objects with presence detector

Object Frost-/Heat protection	Object Comfort mode	Object Standby mode	Object Night mode	Object Window status	Motion button	Motion detector	Operation mode
1	X	X	X	0	0	-	Frost/heat protection
0	1	X	X	0	0	-	Comfort mode
0	0	1	X	0	0	-	Standby mode
0	0	0	1	0	0	-	Night operation
0	0	0	0	0	0	-	no change / last state
X	X	X	X	1	X	-	Frost/heat protection

1	X	X	X	0	1	-	Comfort extension
0	1	X	X	0	1	-	Comfort mode
0	0	1	X	0	1	-	Comfort mode
0	0	0	1	0	1	-	Comfort extension
0	0	0	0	0	1	-	Comfort mode-/ extension *
1	X	X	X	0	-	0	Frost/heat protection
0	1	X	X	0	-	0	Comfort mode
0	0	1	X	0	-	0	Standby mode
0	0	0	1	0	-	0	Night operation
0	0	0	0	0	-	0	no change / last state
X	X	X	X	1	-	X	Frost/heat protection
X	X	X	X	0	-	1	Comfort mode

Table 5: Status of the communication objects and the resulting operating mode

X: Status irrelevant

-: Not possible

*: Dependent on the last active operating mode.

- i When changing over the operating mode, the objects "Comfort mode", "Standby mode", "Night mode" and "Frost/heat protection" are updated by the controller and can be read out when the appropriate Read flags are set. If the "Transmit" flag has been set for these objects the current values will, in addition, be automatically transmitted to the bus when they are changed. After bus voltage recovery or after initialisation of the controller, the object which corresponds to the selected operating mode will be updated and its value actively transmitted to the bus if the "Transmit" flag has been set.
- i In parameterisation of a presence button: the presence object will be active ("1") for the period of an comfort extension. The presence object will be automatically deleted ("0") if the comfort extension is stopped after the extension time has elapsed, or if the operating mode has been changed by a higher-priority operation through the change-over objects. The controller therefore automatically resets the status of the presence button when an object is received via the operating mode objects.

- **Operating mode change-over through "value (1 byte)"**

There is a common 1-byte change-over object for all operating modes. During the running time, the operating mode can be changed over through this value object immediately after the receipt of only one telegram. In this connection, the value received will set the operating mode. In addition, a second 1-byte object is available which, by forced control and through higher level, can set an operating mode, irrespective of any other change-over options. According to the KNX specification, both 1-byte objects have been implemented. Taking account of the priority, a specific hierarchy will result from the operating mode change-over by the objects, a distinction being made between presence detection by the presence button (Figure 31) or presence (Figure 32) detector. In addition, the status of the window in the room can be evaluated using the "Window status" object, meaning that, when the window is open, the controller can switch to Frost/heat protection mode, irrespective of the set operating mode, in order to save energy. Table 6 also shows the status of the communication objects and the resulting operating mode.

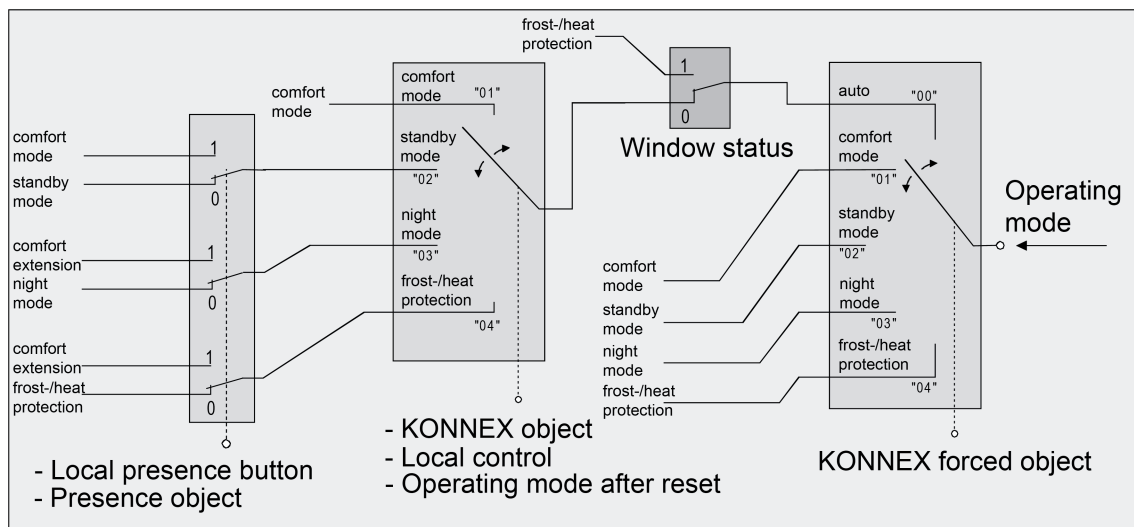

Figure 31: Operating mode change-over through KNX object with presence button

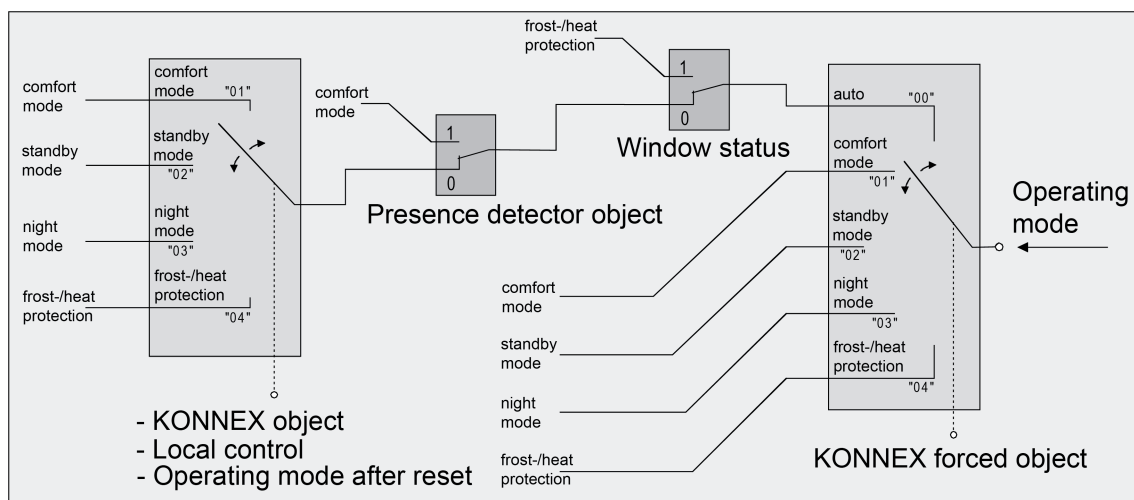

Figure 32: Operating mode change-over through KNX object with presence detector

Object Operating mode Change-over	Object Forced object Operating mode	Object Window status	Motion button	Motion detector	Operating mode
00	00	0	X	0	undefined status, no modification
01	00	0	0	-	Comfort mode
02	00	0	0	-	Standby mode
03	00	0	0	-	Night operation
04	00	0	0	-	Frost/heat protection
01	00	0	1	-	Comfort mode
02	00	0	1	-	Comfort mode
03	00	0	1	-	Comfort extension
04	00	0	1	-	Comfort extension
01	00	0	-	0	Comfort mode
02	00	0	-	0	Standby mode
03	00	0	-	0	Night operation
04	00	0	-	0	Frost/heat protection
X	00	0	-	1	Comfort mode
X	00	1	-	X	Frost/heat protection
X	00	1	X	-	Frost/heat protection
X	01	X	X	X	Comfort mode
X	02	X	X	X	Standby mode
X	03	X	X	X	Night operation
X	04	X	X	X	Frost/heat protection

Table 6: Status of the communication objects and the resulting operating mode

X: Status irrelevant

-: Not possible

- i** When changing over the operating mode, the KNX change-over object is updated by the controller and can be read out if the "Read" flag is set. If the "Transmit" flag has been set for this object the current value will, in addition, be automatically transmitted to the bus when it is changed.
After a device reset, the value corresponding to the set operating mode will be actively transmitted to the bus if the "Transmit" flag has been set.
- i** In parameterisation of a presence button: the presence object will be active ("1") for the period of an active comfort extension. The presence object will be automatically deleted ("0") if the comfort extension is stopped after the extension time has elapsed, or if the operating mode has been changed by a higher-priority operation through the change-over objects or by local control or a forced operating mode is deactivated by the KNX forced object (forced object -> "00"). The controller therefore automatically resets the status of the presence button when an object value is received via the operating mode objects or the forced object is reset.

Additional information on the Presence function / Comfort extension

With a presence detection, the room temperature controller can, in the short-term (1 to 255 minutes) switch over to the comfort extension by KNX telegram or go into the comfort mode when presence is detected by the presence detector. In this connection, the "Presence detection" parameter in the "Room temperature control -> Controller functionality" parameter node sets whether presence detection should be movement-controlled by a motion detector or manual through presence button actuation...

- Presence detection by the presence button

If the presence button is configured for presence detection, then the "Presence object" is enabled. A KNX telegram ("1") to this communication object makes it possible to switch to the comfort extension if night operation or frost/heat protection (not activated by the "Window status" object!) has been activated. The extension will be automatically deactivated as soon as the configured "Length of comfort extension" time has elapsed. If the presence object receives a value = "0", you can deactivate the comfort extension earlier. You cannot re-trigger such extension time.

If you have set the length of comfort extension to "0" in the ETS, you cannot activate a comfort extension from the night or frost/heat protection mode. In this case, the operating mode will not be changed, although the presence function has been activated.

If the standby mode is active, a presence object value = "1" can be used to change over to the comfort mode. This will also be the case if you have configured the length of comfort prolongation to "0". The comfort mode will remain active as long as the presence function remains active, or until another operating mode comes into effect.

The presence object will always be deleted whenever a change-over to a different operating mode takes place, or after a forced operating mode has been deactivated (associated with KNX forced change-over). A presence function activated before a device reset (programming operation, bus voltage failure) is always deleted, along with the object value, after the reset.

- Presence detection by the presence detector

If a presence detector is configured for motion detection, then the controller evaluates the "Presence object". With this object, it is possible to integrate presence detectors into room temperature control. If a movement is detected ("1" telegram) the controller will change over into the Comfort mode. In this connection, it is irrelevant what has been set by the change-over objects or by local control directly on the device. Only a window contact or the KNX forced object are of higher priority.

After the movement delay time has elapsed in the presence detector ("0" telegram), the controller will return to the operating mode which was active before presence detection, or it will compensate the telegrams of the operating mode objects received during presence detection, respectively. During active presence detection, you cannot change-over the operating mode on the room temperature controller.

A presence function activated before a device reset (programming operation, bus voltage failure) is always deleted, along with the object value, after the reset. In this case, the presence detector must transmit a new "1" telegram to the controller to activate the presence function.

Additional information on the window status and the automatic frost protection

The room temperature controller offers various options to change over into the Frost/heat protection mode. In addition to switching-over by means of the corresponding operating mode switch-over object, the frost/heat protection can be activated by a window contact, or alternatively, the frost protection can be activated by an automatic temperature function. With these options, the window contact or the automatic function has higher priority. You can use the "frost/heat protection" parameter in the "room temperature control -> controller general" parameter branch to set the way how such higher-priority switch-over will take place...

- Frost/heat protection switch-over "via window status"
The 1-bit object, "window status" is enabled. A telegram having the value of = "1" (open window) and sent to this object will activate the frost/heat protection mode. If this is the case, the operating mode cannot be deactivated, neither by local operation nor by the switch-over objects (with the exception of the KNX override object). Only a telegram with the value of = "0" (closed window) will reset the window status and deactivate the frost/heat protection mode. After this, the operating mode set before the opening of the window or that mode carried by the KNX while the window was open will be activated.
You can optionally parameterise a window status delay. This delay can make sense if short ventilation of the room by opening the window is not supposed to change the operating mode. You can use the "window status delay" parameter to set this delay time between 1 and 255 minutes. The window status will only be changed and thus the frost/heat protection mode activated after this parameterized time has elapsed. A setting of "0" will effect the immediate activation of the frost/heat protection mode when the window is open. The window status will be in effect in the heating and in the cooling mode. The value of the object "window status" is deleted after a reset.

 - Frost protection mode switch-over by "automatic frost protection"
For this setting, automatic switch-over to the frost protection mode can be made at times, depending on the room temperature determined. If there are no window contacts, this setting can prevent unnecessary heating up of the room when windows or external doors are open. In connection with this function, a quick temperature drop can be detected by measuring the actual temperature every minute as, for example, is the case when a window is open. If the temperature decrease detected reaches a parameterised value the room temperature regulator will automatically switch over to the frost protection mode. You can use the "automatic frost protection temperature drop" parameter to set the maximum temperature drop in K/min for switching over to the frost protection mode. After the time preset by the "frost protection period in automatic mode" parameter has elapsed, the regulator will return into the mode which was set before frost protection. Re-triggering will not be possible.
If a switch-over was made by 1 byte via the KNX change-over object during frost protection and a new operating mode was received, or a new mode has been specified by the heating timer, this followed-up mode will be set after automatic frost protection. If a switch-over was made by 4 x 1 bit during frost protection via the change-over object, then this newly received mode will be discarded after the end of the automatic frost protection. The controller then remains in frost protection. Only after that can the operating mode be switched over by the objects or locally on the push-button sensor. The KNX override object has a higher priority than the automatic frost protection mode and can interrupt the latter.
- i** The automatic frost protection mode only acts on heating for temperatures below the set value temperature of the operating mode selected. Thus, no automatic switch-over to frost protection can take place at room temperatures in the dead band or in the active cooling mode if the "heating and cooling" operating mode is on. Automatic heat protection activation is not intended with this parameterization.
- i** When a window is open or when the automatic frost protection is active, it is not possible to switch over the controller operating mode using buttons with the "Controller operation" function, and not in the menu for the settings. A button press will thus not be effected after the window closes, or at the end of the automatic frost protection.

- i** Frequent draughts in a room can cause unintentional activation/deactivation of frost protection when the automatic frost protection mode is active, and if the parameterized temperature decrease is not low enough. Therefore switching into the frost/heat protection mode by window contacts should generally be preferred to the automatic option.

Additional information on the operating mode after a reset

In the ETS, it is possible to use the "Operating mode after reset" parameter in the "Room temperature control -> Controller general" parameter node to set which operating mode should be activated after bus voltage recovery or re-programming by the ETS. The following settings are possible...

- "Comfort operation" -> The comfort mode will be activated after the initialisation phase.
- "Standby mode" -> The standby mode will be activated after the initialisation phase.
- "Night operation" -> The night mode will be activated after the initialisation phase.
- "Frost/heat protection operation" -> The frost/heat protection mode will be activated after the initialisation phase.

- "Restore operation mode before reset" -> The mode set before a reset according to the operating mode object will be restored after the initializing phase of the device. Operating modes set by a function with a higher priority before the reset (Forced, Window status, Presence status) are not effected.

The objects associated with the activated operating mode will be updated after a reset.

- i** Note on the "restore operation mode before reset" setting:
Frequent changing of the operating mode (e. g. several times a day) during running operation can adversely affect the life of the device as the read-only memory (EEPROM) used has been designed for less frequent write access events only.

4.2.4.5.5 Temperature setpoints

Setpoint temperature presetting

Temperature setpoints can be preset for each operating mode in the ETS as part of first configuration. It is possible to configure the setpoints for the "Comfort", "Standby" and "Night" modes directly (absolute setpoint presetting) or relatively (derivation from basic setpoint). The setpoint temperatures can later be adapted during regular operation if desired, controlled by the KNX communication objects.

- i** The "Frost/heat protection" operating mode allows the separate configuration of two temperature setpoints for heating (frost protection) and cooling (heat protection) solely in the ETS. These temperature values cannot be changed later during controller operation.

The "Setpoint presetting" parameter on the parameter page "Room temperature control -> Controller general -> Setpoints" defines the way the setpoint temperature is preset...

- "Relative (setpoint temperatures from basic setpoint)" setting:
When presetting the set-temperatures for comfort, standby and night mode, attention has to be paid to the fact that all setpoints depend on each other as all values are derived from the basic temperature (basic setpoint). The "Basic temperature after reset" parameter in the "Room temperature control -> Controller general -> Setpoints" parameter page determines the basic setpoint, which is loaded when the device is programmed via the ETS. Taking into account the "Reduce / increase the setpoint temperature in Standby mode" or "Reduce / increase the setpoint temperature in Night mode" parameters, the temperature setpoints for the standby and night mode are derived from this value depending on the heating or cooling operating mode. The deadband will be additionally considered for the "Heating and cooling" operating mode.
The 2-byte object "Basic setpoint" provides the option of changing the basic temperature, and thus all the dependent setpoint temperatures during device operation. A change via the object must always be enabled in the ETS by configuring the parameter "Change the basic temperature setpoint via bus" to "Approve". If the basic setpoint adjustment via the bus is disabled, the "Basic setpoint" object will be hidden. The controller rounds the temperature values received via the object to the configured interval of the basic setpoint shift (0.1 K, 0.5 K or 1.0 K).
- "Absolute (independent setpoint temperatures)" setting
The setpoint temperatures for comfort, standby and night mode are independent of each other. Depending on the operating mode and heating/cooling mode, various temperature values can be specified in the ETS within the range +7.0 °C to +40.0 °C. The ETS does not validate the temperature values. It is thus possible, for example, to select smaller setpoint temperatures for cooling mode than for heating mode, or to specify lower temperatures for comfort mode than for standby mode.
After commissioning using the ETS the setpoint temperatures can be changed via the bus by means of temperature telegrams. This can be done using the communication object "Setpoint active operating mode". When the controller receives a telegram via this object, it immediately sets the received temperature as the new setpoint of the active operating mode, and operates from then on with this setpoint. In this manner it is possible to adapt the setpoint temperatures of all operating modes separately for heating and cooling mode. The frost or heat protection temperature programmed in using the ETS cannot be changed in this manner.
- i** With absolute setpoint presetting there is no basic setpoint and also no deadband in the mixed operating mode "Heating and cooling" (if necessary also with additional level). Consequently, the room temperature controller cannot control the switchover of the operating mode automatically, which is why, in this configuration, the setting for the parameter "Switchover between heating and cooling" is fixed in the ETS to "Via object". Furthermore, setpoint shifting does not exist for absolute setpoint presetting.

- i** Since the setpoint shift option is not necessary when using the absolute setpoint presetting, the status LED function "Setpoint value shift display" is also ineffective.

The temperature setpoints programmed in the room temperature controller by the ETS during commissioning can be changed via communication objects. In the ETS the parameter "Overwrite setpoints in device during ETS programming operation?" can be used on the parameter page "Room temperature control -> Controller general -> Setpoints" to define whether the setpoints present in the device, which may have been changed subsequently, are overwritten during an ETS programming operation and thus replaced again by the values parameterised in the ETS. If this parameter is on "Yes", then the temperature setpoints are deleted in the device during a programming operation and replaced by the values of the ETS. If this parameter is configured to "No", then setpoints present in the device remain unchanged. The setpoint temperatures entered in the ETS then have no significance.

- i** During initial commissioning of the device the parameter "Overwrite setpoints in device during ETS programming operation?" must be set to "Yes" in order to perform valid initialisation of the memory slots in the device. The setting "Yes" is also necessary if essential controller properties (operating mode, setpoint presetting, etc.) are being changed in the ETS using new parameter configurations!

Setpoint temperatures for relative setpoint presetting

Depending on the operating mode, different cases should be distinguished when specifying the relative setpoint temperature, which then have an impact on the temperature derivation from the basic setpoint.

Setpoints for operating mode "Heating"

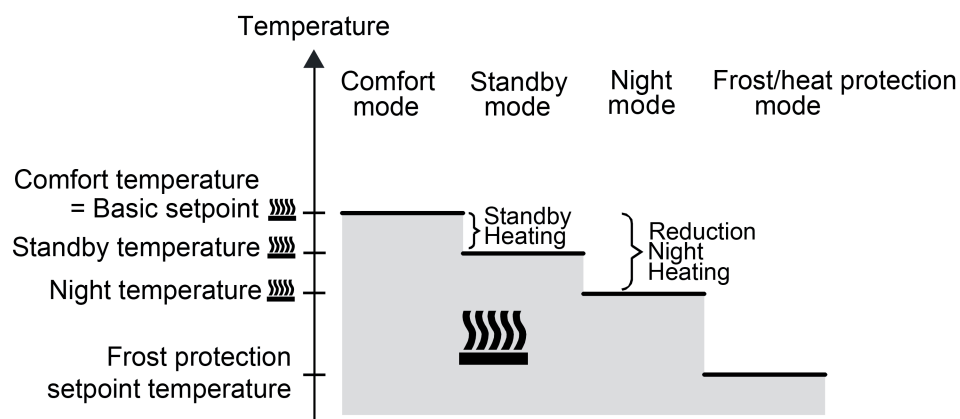

Figure 33: Setpoint temperatures in the operating mode "Heating"

The setpoint temperatures for comfort, standby and night mode exist for this operating mode. The frost protection temperature can be preset(Figure 33).
The following applies

$$T_{\text{Standby setpoint heating}} \leq T_{\text{Comfort setpoint heating}}$$

or

$$T_{\text{Night setpoint heating}} \leq T_{\text{Comfort setpoint heating}}$$

The standby and night setpoint temperatures are derived from the reduction temperatures configured in the ETS from the comfort setpoint temperature (basic setpoint). The frost protection is supposed to prevent the heating system from freezing. For this reason the frost protection temperature (default: +7 °C) should be to a set smaller value than the night temperature. In principle, however, it is possible to select frost protection temperature values between +7.0 °C and +40.0 °C. The possible range of values for a setpoint temperature lies between +7.0 °C and +99.9 °C for "heating" and is bounded by the frost protection temperature in the lower range.

The level offset configured in ETS will be additionally considered in a two-level heating mode (Figure 34).

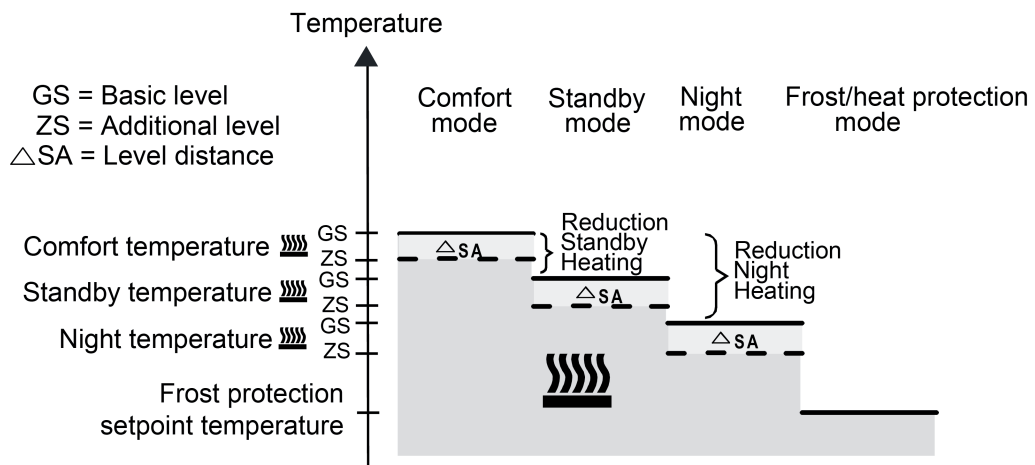

Figure 34: Setpoint temperatures in the operating mode "Basic and additional heating"

$$T_{\text{Comfort setpoint additional level heating}} \leq T_{\text{Comfort setpoint basic level heating}}$$

$$T_{\text{Standby setpoint additional level heating}} \leq T_{\text{Standby setpoint basic level heating}}$$

$$T_{\text{Standby setpoint heating}} \leq T_{\text{Comfort setpoint heating}}$$

or

$$T_{\text{Comfort setpoint additional level heating}} \leq T_{\text{Comfort setpoint basic level heating}}$$

$$T_{\text{Night setpoint additional level heating}} \leq T_{\text{Night setpoint basic level heating}}$$

$$T_{\text{Night setpoint heating}} \leq T_{\text{Comfort setpoint heating}}$$

Setpoints for the "cooling" operating mode

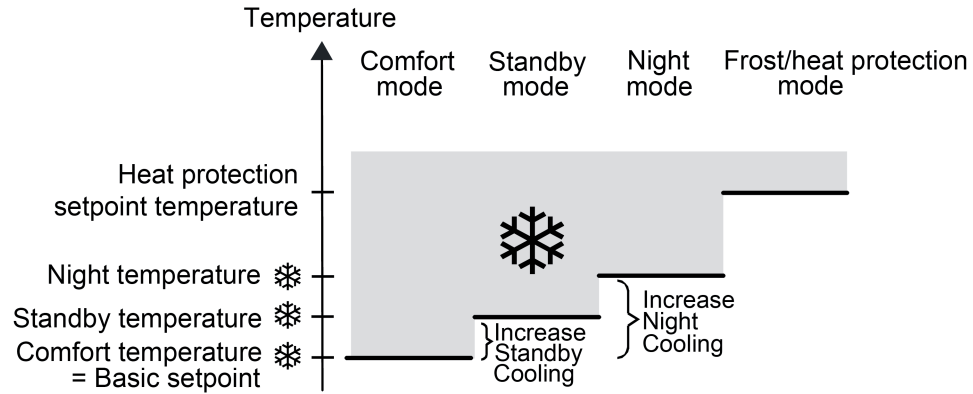

Figure 35: Setpoint temperatures in the operating mode "Cooling"

The setpoint temperatures for comfort, standby and night mode exist for this operating mode. The heat protection temperature can be preset(Figure 35). The following applies...

$$T_{\text{Comfort setpoint cooling}} \leq T_{\text{Standby setpoint cooling}}$$

or

$$T_{\text{Comfort setpoint cooling}} \leq T_{\text{Night setpoint cooling}}$$

The standby and night set-temperatures are derived after the configured increase temperatures from the comfort set-temperature (basic setpoint). The heat protection is supposed to ensure that the temperature does not exceed the maximum permissible room temperature in order to protect system components. For this reason the heat protection temperature (default: +35 °C) should be set to a larger value than the night temperature. In principle, however, it is possible to select heat protection temperature values between +7.0 °C and +45.0 °C. The possible range of values for a setpoint temperature lies between -99.9 °C and +45.0 °C for "cooling" and is bounded by the heat protection temperature in the upper range.

The level offset configured in ETS will be additionally considered in a two-level cooling mode(Figure 36).

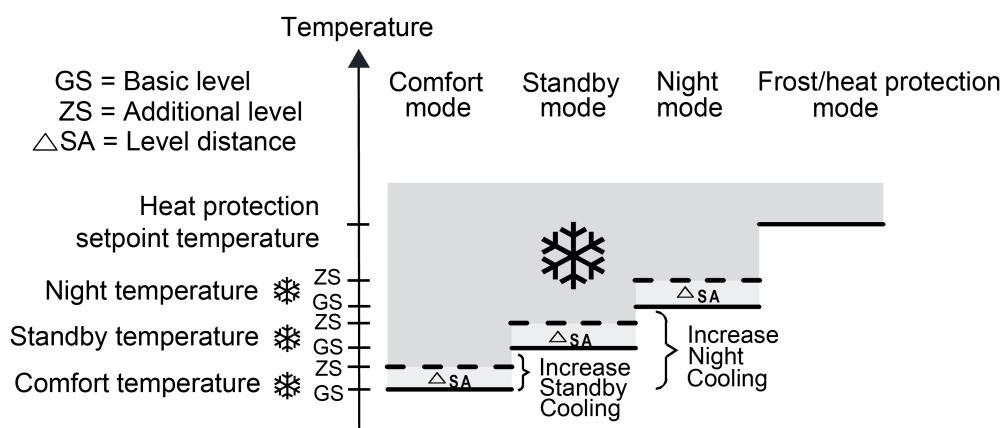

Figure 36: Setpoint temperatures in the operating mode "Basic and additional cooling"

$$T_{\text{Comfort setpoint basic level heating}} \leq T_{\text{Comfort setpoint additional level heating}}$$

$$T_{\text{Standby setpoint basic level heating}} \leq T_{\text{Standby setpoint additional level heating}}$$

$$T_{\text{Comfort setpoint cooling}} \leq T_{\text{Standby setpoint cooling}}$$

or

$$T_{\text{Comfort setpoint basic level heating}} \leq T_{\text{Comfort setpoint additional level heating}}$$

$$T_{\text{Night setpoint basic level heating}} \leq T_{\text{Night setpoint additional level heating}}$$

$$T_{\text{Comfort setpoint cooling}} \leq T_{\text{Night setpoint cooling}}$$

Setpoints for the "heating and cooling" operating mode

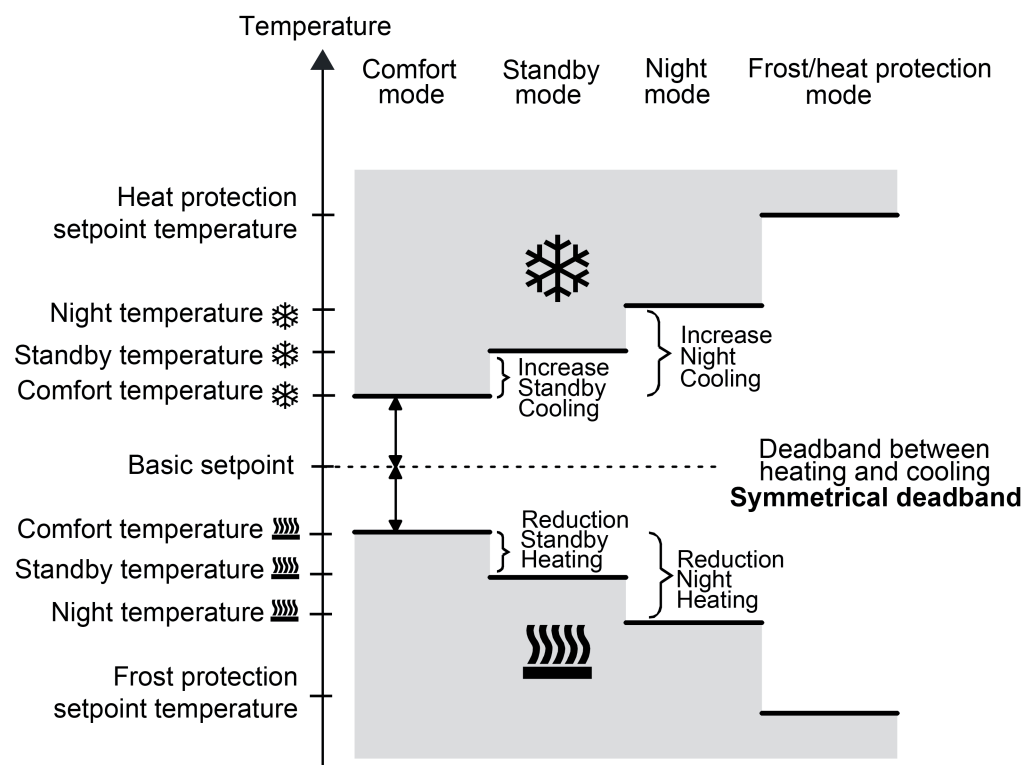

Figure 37: Setpoint temperatures in the operating mode "Heating and cooling" with symmetrical deadband

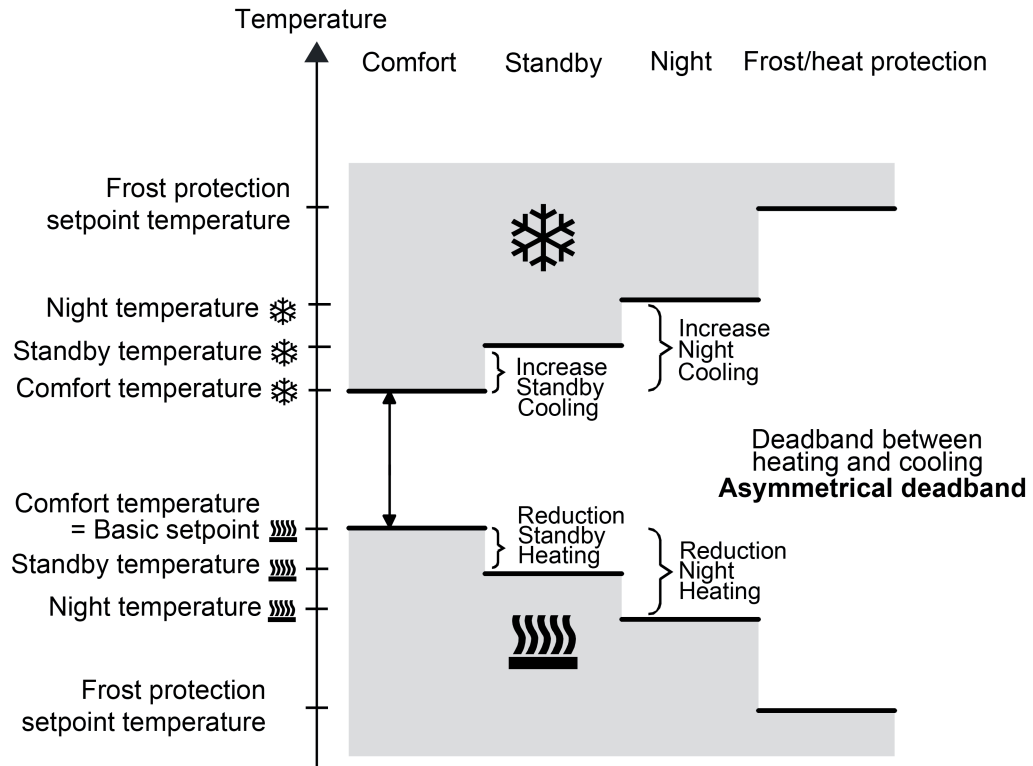

Figure 38: Setpoint temperatures in the operating mode "Heating and cooling" with asymmetrical deadband

For this heating/cooling operating mode, the setpoint temperatures of both heating/cooling modes exist for the Comfort, Standby and Night operating modes as well as the deadband. A distinction is made in the deadband position with combined heating and cooling. A symmetrical (Figure 37) or an asymmetrical (Figure 38) dead zone position can be configured. In addition, the frost protection and the heat protection temperatures can be preset.

The following applies...

$$T_{\text{Standby setpoint heating}} \leq T_{\text{Comfort setpoint heating}} \leq T_{\text{Comfort setpoint cooling}} \leq T_{\text{Standby setpoint cooling}}$$

or

$$T_{\text{Night setpoint heating}} \leq T_{\text{Comfort setpoint heating}} \leq T_{\text{Comfort setpoint cooling}} \leq T_{\text{Night setpoint cooling}}$$

The set-temperatures for "Standby" and "Night" are derived from the comfort setpoint temperatures for heating or cooling. The temperature increase (for cooling) and the temperature decrease (for heating) of both operating modes can be preset in ETS. The comfort temperatures itself are derived from the deadband and the basic setpoint.

The frost protection is supposed to prevent the heating system from freezing. For this reason the frost protection temperature (default: +7 °C) should be set to a smaller value than the night temperature for heating. In principle, however, it is possible to select frost protection temperature values between +7.0 °C and +40.0 °C. The heat protection is supposed to ensure that the temperature does not exceed the maximum permissible room temperature in order to protect system components. For this reason the heat protection temperature (default: +35 °C) should be set to a larger value than the night temperature for cooling. In principle, however, it is possible to select heat protection temperature values between +7.0 °C and +45.0 °C.

The possible range of values for a setpoint temperature ("heating and cooling") lies between +7.0 °C and +45.0 °C and is bounded by the frost protection temperature in the lower range and by the heat protection temperature in the upper range.

The level offset configured in ETS will be additionally considered in a two-level heating or cooling mode.

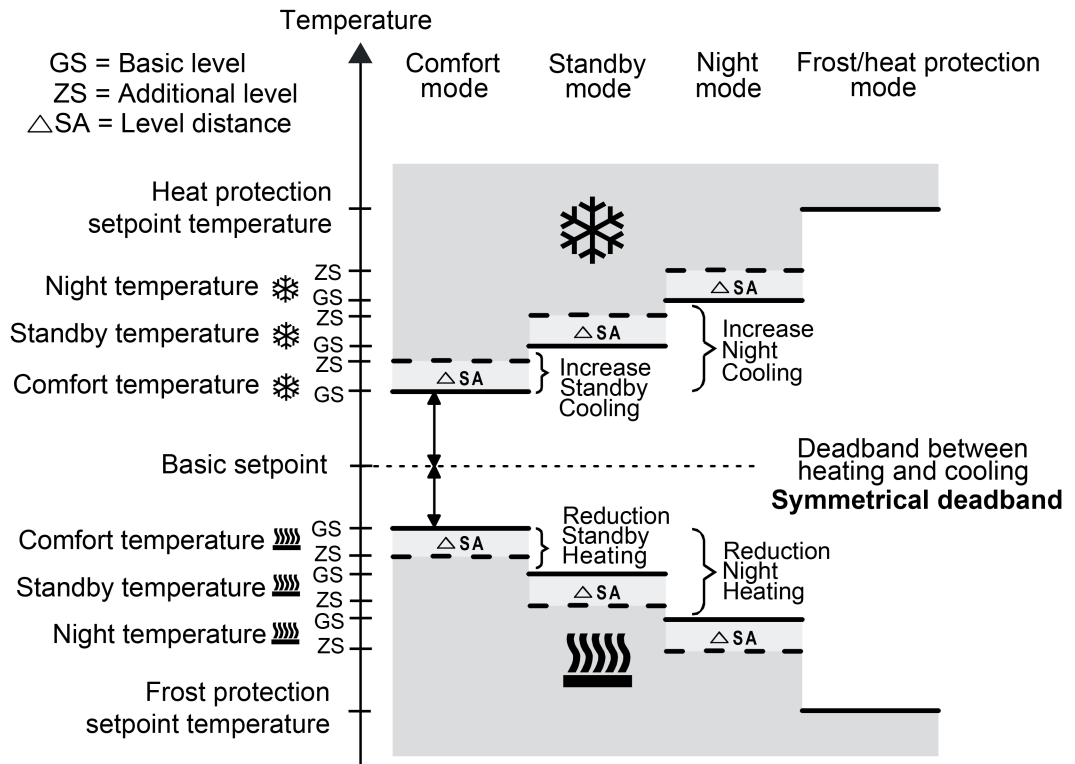

Figure 39: Setpoint temperatures in the operating mode "Basic and additional heating and cooling" with symmetrical deadband

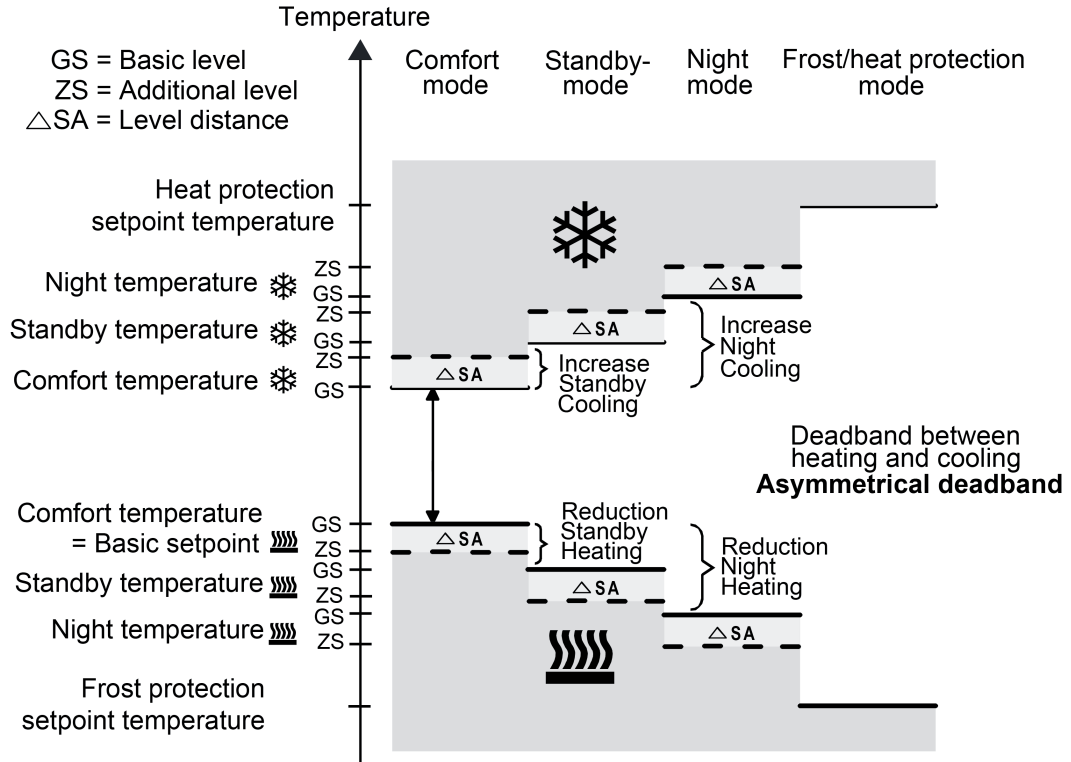

Figure 40: Setpoint temperatures in the operating mode "Basic and additional heating and cooling" with asymmetrical deadband

$$T_{\text{Comfort setpoint add. level Heating}} \leq T_{\text{Comfort setpoint basic level Heating}} \leq T_{\text{Comfort setpoint basic level Cooling}} \leq T_{\text{Comfort setpoint add. level Cooling}}$$

$$T_{\text{Standby setpoint add. level Heating}} \leq T_{\text{Standby setpoint basic level Heating}} \leq T_{\text{Standby setpoint basic level Cooling}} \leq T_{\text{Standby setpoint add. level Cooling}}$$

$$T_{\text{Standby setpoint heating}} \leq T_{\text{Comfort setpoint heating}} \leq T_{\text{Comfort setpoint cooling}} \leq T_{\text{Standby setpoint cooling}}$$

OR

$$T_{\text{Comfort setpoint add. level Heating}} \leq T_{\text{Comfort setpoint basic level Heating}} \leq T_{\text{Comfort setpoint basic level Cooling}} \leq T_{\text{Comfort setpoint add. level Cooling}}$$

$$T_{\text{Night setpoint add. level Heating}} \leq T_{\text{Night setpoint basic level Heating}} \leq T_{\text{Night setpoint basic level Cooling}} \leq T_{\text{Night setpoint add. level Cooling}}$$

$$T_{\text{Night setpoint heating}} \leq T_{\text{Comfort setpoint heating}} \leq T_{\text{Comfort setpoint cooling}} \leq T_{\text{Night setpoint cooling}}$$

deadband and deadband positions in the combined heating and cooling operating mode

With relative setpoint presetting, the comfort setpoint temperatures for heating and cooling are derived from the basic setpoint in consideration of the adjusted Dead band. The deadband (temperature zone for which there is neither heating nor cooling) is the difference between the comfort setpoint temperatures. This deadband does not exist for absolute setpoint presetting.

The "deadband between heating and cooling", "deadband position" parameters as well as the "Basic temperature after reset" parameter are preset in the ETS configuration. One distinguishes between the following settings...

- deadband = "symmetrical"
The deadband preset in the ETS is divided into two parts at the basic setpoint. The comfort setpoint temperatures are derived directly from the basic setpoint resulting from the half deadband.

The following applies...

$$T_{\text{Basic setpoint}} - \frac{1}{2}T_{\text{deadband}} = T_{\text{Comfort heating setpoint}}$$

and

$$T_{\text{Basic setpoint}} + \frac{1}{2}T_{\text{deadband}} = T_{\text{Comfort setpoint cooling}}$$

$$\rightarrow T_{\text{Comfort cooling setpoint}} - T_{\text{Comfort heating setpoint}} = T_{\text{deadband}}$$

$$\rightarrow T_{\text{Comfort cooling setpoint}} \geq T_{\text{Comfort heating setpoint}}$$

- deadband position = "Asymmetrical"
With this setting the comfort setpoint temperature for heating equals the basic setpoint. The deadband preset in the ETS is effective only from the basic setpoint in the direction of comfort temperature for cooling. Thus the comfort set-temperature for cooling is derived directly from the comfort setpoint for heating.

The following applies...

$$T_{\text{Basic setpoint}} = T_{\text{Comfort heating setpoint}}$$

$$\rightarrow T_{\text{Basic setpoint}} + T_{\text{deadband}} = T_{\text{Comfort cooling setpoint}}$$

$$\rightarrow T_{\text{Comfort cooling setpoint}} - T_{\text{Comfort heating setpoint}} = T_{\text{deadband}}$$

$$\rightarrow T_{\text{Comfort cooling setpoint}} \geq T_{\text{Comfort heating setpoint}}$$

Accept setpoints permanently

If the basic setpoint has been modified by the communication objects "Basic setpoint" or "Setpoint of active operating mode", two possible cases can be distinguished, which are set by the parameter "Apply change of the setpoint of the basic temperature" (with relative setpoint presetting) or "Apply change of the setpoint permanently" (with absolute setpoint presetting)...

- Case 1: The setpoint adjustment is permanently accepted ("Yes" setting):
If, with this setting, the temperature setpoint is adjusted, the controller saves the value permanently to the EEPROM (permanent storage). The newly adjusted value will overwrite the initial value, i.e. the basic temperature originally configured via the ETS after a reset or the absolute setpoint temperature loaded using the ETS. The changed values are also retained after a device reset, after a switch-over of the operating mode or after a switch-over of the heating/cooling mode (with absolute setpoint presetting individually for each operating mode for heating and cooling).
With this setting, it should be noted that frequent changing of the basic temperature (e.g. several times a day because of cyclical telegrams) can affect the product life of the device as the non-volatile storage is designed for less frequent write access.
The "Basic setpoint" object (relative setpoint presetting) is not bidirectional, meaning that a shifted basic setpoint is not signalled back to the KNX. The object "Setpoint active operating mode" (absolute setpoint presetting) can be bidirectional if necessary (set "Transmit" flag!). This makes it possible to use this object to feedback to the bus the setpoint temperature resulting from a setpoint shift.
 - Case 2: The basic setpoint adjustment is only temporarily accepted ("No" setting):
The setpoints received via the objects remain active only temporarily. In case of a bus voltage failure or following a switch-over to another operating mode (e.g. Comfort followed by Standby, or also Comfort followed by Comfort), or after a switch-over of the heating/cooling mode (e.g. heating after cooling), the last setpoint changed will be discarded and replaced by the initial value.
- i** If the setpoint is accepted on a non-temporary basis ("Yes" setting), the setpoints restored after a device reset are not effected immediately in the communication objects. Only after the telegrams have been received from the bus via the objects and the room temperature controller accepts the newly received setpoint can the objects be read out, for example for visualisation purposes (Set "Read" flag!).
- i** With relative setpoint presetting: Independent of the "accept modification of the basic temperature setpoint value permanently" parameter, the temperature setpoints for the standby or night mode or "cooling" comfort mode (deadband) will always be stored in the non-volatile EEPROM memory.
With absolute setpoint presetting: As described, dependent on the "accept modification of the setpoint value permanently" parameter, the temperature setpoints for the standby or night mode for heating or cooling will always be stored in the volatile or non-volatile memory.

Basic setpoint shift for relative setpoint presetting

In addition to presetting individual temperature setpoints by the ETS or basic setpoint object, the user, when presetting relative setpoints, can shift the basic setpoint in predefined limits within a specific range. When doing so, the basic setpoint is adjusted up or down in levels. The step width of the setpoint shift is defined by the parameter of the same name (0.1 K, 0.5 K or 1.0 K).

- i** No basic setpoint shift can be performed if the controller is configured for absolute setpoint presetting.

- i** It has to be considered that a shift of the displayed setpoint temperature (temperature offset of the basic temperature) will directly affect the basic setpoint and as a result shift all other temperature setpoints.
A positive shift is possible up to the configured heat protection temperature. A negative shift is possible up to the set frost protection temperature.

- i** The "Basic setpoint" object is not bidirectional, meaning that a shifted basic setpoint is not signalled back to the KNX.

Whether a basic setpoint shifting only affects the currently active operating mode or whether it influences all other set-temperatures of the remaining operating modes is determined by the "Permanently apply change to basic setpoint shift" parameter in the "Room temperature control -> Controller general -> Setpoints" parameter page...

- "No" setting:
The basic setpoint shifting carried out is in effect for only as long as the operating mode or heating/cooling mode has not changed or the basic setpoint is maintained. Otherwise the setpoint shift will be reset to "0".

- Setting "yes":
In general, the shifting of the basic setpoint carried out affects all operating modes. The shift is maintained even after a switchover of the operating mode or the heating/cooling mode or adjusting the basic setpoint.

- i** Since the value for the basic setpoint shift is stored exclusively in volatile memory (RAM), the shift will get lost in case of a reset (e.g. bus voltage failure).

- i** A setpoint shift does not affect the temperature setpoints for frost or heat protection!

Communication objects for the basic setpoint shift:

The setpoint shift of the controller can be adjusted externally by the communication object "Setpoint shift specification" with a 1-byte counter value (in compliance with KNX DPT 6.010 – Depiction of positive and negative values in a double complement. By connecting to the "Setpoint shift specification" object the controller extensions are able to directly adjust the current setpoint shift of the controller. As soon as the controller receives a value, it will adjust the setpoint shift correspondingly. Values that lie within the possible value range of the basic setpoint shift can be directly jumped to.

The controller monitors the received value independently. As soon as the external preset value exceeds the limits of the adjustment options for the setpoint shift in positive or negative direction, the controller will correct the received value and adjust the setpoint shift to maximum. Depending on the direction of the shift, the value feedback is set to the maximum value via the communication object "Current setpoint shift".

The current setpoint shift is tracked by the controller in the communication object "Current setpoint shift". This object has the same data point type and value range as the object "Setpoint shift specification" (see above). By connecting to this object the controller extensions are also able to display the current setpoint shift. As soon as there is an adjustment by one temperature increment in positive direction, the controller counts up the value. The counter value will be counted down if there is a negative adjustment of the temperature. A value of "0" means that no setpoint shifting has been adjusted.

Example:

Starting situation: current setpoint temperature = 21.0°C / Counter value in "Current setpoint shift" = "0" (no active setpoint shift)

After the setpoint shifting:

-> A setpoint shift by one temperature increment in the positive direction will count up the value in the "Current setpoint shift" object by one = "1".

-> Current setpoint temperature = 21.5°C

-> An additional setpoint shift by one temperature increment in the positive direction will again count up the value in the "Current setpoint shift" object by one = "2".

-> Current setpoint temperature = 22.0°C

-> A setpoint shift by one temperature increment in the negative direction will count down the value in the "Current setpoint shift" object by one = "1".

-> Current setpoint temperature = 21.5°C

-> An additional setpoint shift by one temperature increment in the negative direction will again count down the value in the "Current setpoint shift" object by one = "0".

-> Current setpoint temperature = 21.0°C

-> An additional setpoint shift by one temperature increment in the negative direction will again count down the value in the "Current setpoint shift" object by one = "-1".

-> Current setpoint temperature = 20.5°C, etc. ...

- i** To ensure that controller extensions indicate the correct shifts and also control the functions of the controller (as main unit) correctly, it is necessary for the controller extensions to be set to the same shift limits of the setpoint shift as the main unit. Controller extensions must work with the same step width for the setpoint shift as the controller itself (0.1 K, 0.5 K or 1.0 K).

Transmitting the setpoint temperature

The setpoint temperature, which is given by the active operating mode can be actively transmitted onto the bus via the 2-byte "Set temperature" object. The "Transmission at setpoint temperature modification by..." parameter in the "Room temperature control -> controller general -> setpoint values" parameter node determines the temperature value by which the setpoint has to change in order to have the setpoint temperature value transmitted automatically via the object. Possible temperature value changes lie within a range of 0.1 K and 25.5 K. The setting "0" at this point will deactivate the automatic transmission of the setpoint temperature.

In addition, the setpoint can be transmitted periodically. The "Cyclical transmission of setpoint temperature" parameter determines the cycle time (1 to 255 minutes). The value "0" will deactivate the periodical transmission of the setpoint temperature value. It has to be pointed out that with deactivated periodical transmission and deactivated automatic transmission, no setpoint temperature telegrams will be transmitted in case of a change.

Setting the "Read" flag on the "Setpoint temperature" object makes it possible to read out the current setpoint. Following the return of bus voltage or after re-programming via the ETS, the object value will be initialised according to the current setpoint temperature value and actively transmitted to the bus.

4.2.4.5.6 Command value and status output

Command value objects

The format of the command value objects are determined depending on the control algorithm selected for heating and / or cooling and, if applicable, also for the additional levels. 1 bit or 1 byte command value objects can be created in the ETS. The control algorithm calculates the command values in intervals of 30 seconds and outputs them via the objects. With the pulse width modulated PI control (PWM) the command value is updated, if required, solely at the end of a time cycle.

Possible object data formats for the command values separately for both heating/cooling operating modes, for the basic and the additional level or for both control circuits are...

- continuous PI control: 1 byte
- Switching PI control: 1 bit + additionally 1 byte (for example for the status indication with visualisations),
- switching 2-point feedback control: 1 bit.

Depending on the selected heating/cooling operating mode, the controller is able to address heating and / or cooling systems, to determine command values and to output them via separate objects. One distinguishes between two cases for the "Heating and cooling" mixed operating mode...

- Case 1: Heating and cooling system are two separate systems
In this case the "Transmit heating and cooling command value to one common object" parameter should be set to "No" in the "Room temperature control -> Controller functions" parameter node. Thus, there are separate objects available for each command value, which can be separately activated via the individual systems.
This setting allows to define separate types of control for heating and cooling.
- Case 2: Heating and cooling system are a combined system
In this case the "Transmit heating and cooling command value to one common object" parameter may be set, if required, to "Yes". This will transmit the command values for heating and cooling to the same object. In case of a two-level feedback control, another shared object will be enabled for the additional levels for heating and cooling.
With this setting it is only possible to define the same type of feedback control for heating and for cooling as the feedback control and the data format must be identical. The ("Type of heating / cooling") control parameter for cooling and heating still has to be defined separately.
A combined command value object may be required, for example, if heating as well as cooling shall take place via a single-pipe system (combined heating and cooling system). For this, the temperature of the medium in the single-pipe system must be changed via the system control. Afterwards the heating/cooling operating mode is set via the object (often the single-pipe system uses cold water for cooling during the summer, hot water for heating during the winter).

If required, the command value can be inverted before the transmission to the KNX/EIB. With output via a combined object, the parameters "Output of heating command value", "Output of cooling command value" or "Output of command values..." output the command value in inverted fashion according to the object data format. The parameters for inverting the additional level(s) are additionally available in the two-level control.

The following applies...

For continuous command values:

-> not inverted: Command value 0 % ... 100 %, value 0 ... 255

-> inverted: Command value 0 % ... 100 %, value 255 ... 0

For switching command values:

-> not inverted: Command value off / on, value 0 / 1

-> inverted: Command value off / on, value 1 / 0

Automatic transmission

On automatic transmission, a distinction is made with regard to the type of control...

- Continuous PI control:
In case of a continuous PI control, the room temperature controller calculates a new command value periodically every 30 seconds and outputs it to the bus via a 1-byte value object. The change interval of the command value can be determined in percent according to which a new command value is to be output on the bus via the "Automatic transmission on change by..." parameter in the "Room temperature control -> Controller general -> Command values and status output" parameter node. The change interval can be configured to "0" so that a change in the command value will not result in an automatic transmission.
In addition to the command value output following a change, the current command value value may be periodically transmitted on the bus. In addition to the times when changes are to be expected, other command value telegrams will be output according to the active value after a configurable cycle time. This ensures that during a periodic access control of the command value in servo drive or in the addressed switching actuator, telegrams are received within the control interval. The time interval predetermined by the "Cycle time for automatic transmission..." parameter should correspond to the control interval in the actuator (cycle time in the controller is preferably to be configured smaller). The "0" setting will deactivate the periodic transmission of the command value.
With continuous PI control it must be noted that if the cyclical and the automatic transmission are both deactivated, no command value telegrams will be transmitted in case of a change!

- Switching PI control (PWM):
In case of a switching PI control (PWM), the room temperature controller calculates a new command value internally every 30 seconds. With this control, however, the update of the command value takes place, if required, solely at the end of a PWM cycle. The parameters "automatic transmission on change by..." and "Cycle time for automatic transmission..." are not enabled with this control algorithm. The parameter "Cycle time of the switching command value..." defines the cycle time of the PWM command value signal.

- 2-point feedback control:
In case of a 2-point feedback control, the room temperature and thus the hysteresis values are evaluated periodically every 30 seconds, so that the command values, if required, will change solely during these times. The "Automatic transmission on change by..." parameter is not enabled as this control algorithm does not calculate continuous command values.
In addition to the command value output following a change, the current command value value may be periodically transmitted on the bus. In addition to the times when changes are to be expected, other command value telegrams will be output according to the active value after a configurable cycle time. This ensures that during a periodic access control of the command value in servo drive or in the addressed switching actuator, telegrams are received within the control interval. The time interval predetermined by the "Cycle time for automatic transmission..." parameter should correspond to the control interval in the actuator (cycle time in the controller is preferably to be configured smaller). The "0" setting will deactivate the periodic transmission of the command value.

Controller status

The room temperature controller can transmit its current status to the KNX/EIB. A choice of data formats is available for this. The "Controller status" parameter in the "Room temperature control -> Controller general -> Command value and status output" parameter branch will enable the status signal and set the status format...

- "KNX compliant"
The KNX-compliant controller status feedback is harmonised on a manufacturer-specific basis, and consists of 3 communication objects. The 2-byte object "KNX status" (DPT 22.101) indicates elementary functions of the controller (see Table 8). This object is supplemented by the two 1-byte objects "KNX status operating mode" and "KNX status forced operating mode" (DPT 20.102), which report back the operating mode actually set on the controller. The last two objects mentioned above are generally used to enable controller extensions to display the controller operating mode correctly in the KNX compliant status display. Therefore, these objects should be connected with controller extensions if the KNX-compliant status feedback is not configured.

Bit of the status telegram	Meaning
0	Controller error status ("0" = no error / "1" = error)
1	not used (permanent "0")
2	not used (permanent "0")
3	not used (permanent "0")
4	not used (permanent "0")
5	not used (permanent "0")
6	not used (permanent "0")
7	not used (permanent "0")
8	Operating mode ("0" = Cooling / "1" = Heating)
9	not used (permanent "0")
10	not used (permanent "0")
11	not used (permanent "0")
12	Controller disabled (dew point operation) ("0" = Controller enabled / "1" = Controller disabled)
13	Frost alarm ("0" = Frost protection temperature exceeded / "1" = frost protection temperature undershot)
14	Heat alarm ("0" = heat protection temperature exceeded / "1" = Heat protection temperature exceeded)
15	not used (permanent "0")

Table 8: Bit encoding of the 2 byte KNX compliant status telegram

- "Controller general":
The general controller status collects essential status information of the controller in two 1-byte communication objects. The "Controller status" object contains fundamental status information (see Table 9). The "Status signal addition" object collects in a bit-orientated manner further information that is not available via the "Controller status" object (see Table 10). For example, controller extensions can evaluate the additional status information, in order to be able to display all the necessary controller status information on the extension display.

Bit of the status telegram	Meaning
0	On "1": Comfort operation activated
1	On "1": Standby mode active
2	On "1": Night mode active
3	On "1": Frost/heat protection mode active
4	On "1": Controller disabled
5	On "1": Heating, on "0": Cooling
6	On "1": Controller inactive (deadband)
7	On "1": Frost alarm ($T_{\text{Room}} \leq +5 \text{ }^{\circ}\text{C}$)

Table 9: Bit encoding of the 1 byte status telegram

Bit of the status telegram	Meaning on "1"	Meaning on "0"
0	Normal operating mode	Forced operating mode
1	Comfort extension active	No comfort extension
2	Presence (Presence detector)	No presence (Presence detector)
3	Presence (Presence button)	No presence (Presence button)
4	Window opened	No window opened
5	Additional level active	Additional level inactive
6	Heat protection active	Heat protection inactive
7	Controller disabled (dew point operation)	Controller not disabled

Table 10: Bit encoding of the 1 byte additional status telegram

- "Transmit individual state"
The 1 bit status object "Controller status, ..." contains the status information selected by the "Single status" parameter. Meaning of the status signals:
 - "Comfort mode active" -> Active if operating mode "Comfort " or a comfort extension "" is activated.
 - "Standby mode active" -> active if the "standby " operating mode is activated.
 - "Night-mode active" -> active if the "night " operating mode is activated.
 - "Frost/heat protection active" -> active if the "frost/heat protection" operating mode is activated.
 - "Controller disabled" -> Active if controller disable is activated (dew point mode).
 - "Heating / cooling" -> Active if heating is activated and inactive if cooling is activated. Inactive if controller is disabled.
 - "Controller inactive" -> Active with the "heating and cooling" operating mode when the measured room temperature lies within the dead zone. This status information is always "0" for the individual "Heating" or "Cooling" operating modes. Inactive if controller is disabled.
 - "Frost alarm" -> Is active if the detected room temperature reaches or falls below +5 °C. This status signal will have no special influence on the control behaviour.

i Upon a reset, the status objects will be updated after the initialisation phase. After this, updating is performed cyclically every 30 seconds in parallel with the command value calculation of the controller command values. Telegrams are only transmitted to the bus when the status changes.

Additional controller status

The additional controller status is a 1-byte object, in whose value various information is collected in orientated to bits. In this way, controller statuses, which are not available via the 'normal' 1-bit or 1-byte controller status, can be displayed on other KNX/EIB devices or processed further (see Table 11). For example, controller extensions can evaluate the additional status information, in order to be able to display all the necessary controller status information on the extension display.

The 1-byte object "Status signal addition" is a pure visualisation object, which cannot be written.

i The object "Status signal addition" is only visible when the parameter "Status controller" is configured to "Controller general".

Bit of the status telegram	Meaning on "1"	Meaning on "0"
0	Normal operating mode	Forced operating mode
1	Comfort extension active	No comfort extension
2	Presence (Presence detector)	No presence (Presence detector)
3	Presence (Presence button)	No presence (Presence button)
4	Window opened	No window opened

5	Additional level active	Additional level inactive
6	Heat protection active	Heat protection inactive
7	Controller disabled (dew point operation)	Controller not disabled

Table 11: Bit encoding of the 1 byte additional status telegram

- i** Upon a reset, the additional status object will be updated after the initialisation phase. After this, the status will be updated cyclically every 30 seconds in parallel with the command value calculation of the controller command values.

Command value limit

Optionally a command value limit can be configured in the ETS. The command value limit allows the restriction of calculated command values to the range limits "minimum" and "maximum". The limits are permanently set in the ETS and, if command value limitation is active, can be neither undershot or exceeded during device operation. It is possible, if available, to specify various limiting values for the basic and additional stages and for heating and cooling.

- i** It should be noted that the command value limit has no effect with "2-point feedback control" and with "Transmitting of command values for heating and cooling via a common object"! In that case it is still possible to configure the command value limit in the ETS, but it will have no function.

The "Command value limit" parameter on the parameter page "Room temperature control -> Controller general -> Command values and status output" defines the mode of action of the limiting function. The command value limit can either be activated or deactivated using the 1-bit communication object "Command value limit", or be permanently active. When controlling via the object, it is possible to have the controller activate the command value limit automatically after bus voltage return or an ETS programming operation. Here the "Command value limit after reset" parameter defines the initialisation behaviour. In the "Deactivated" setting, the command value limit is not automatically activated after a device reset. A "1" telegram must first be received via the "Command value limit" object for the limit to be activated. In the "Activated" setting, the controller activates the command value limit automatically after a device reset. To deactivate the limit a "0" telegram must be received via the "Command value limit" object. The limit can be switched on or off at any time using the object.

With a permanently active command value limit, the initialisation behaviour cannot be configured separately after a device reset, as the limit is always active. In this case it is also not possible to configure any object.

As soon as the command value limit is active, calculated command values are limited according to the limiting values from the ETS. The behaviour with regard to the minimum or maximum command value is then as follows...

- **Minimum command value:**
The "Minimum command value" parameter specifies the lower command value limiting value. The setting can be made in 5 % increments in the range 5 % ... 50 %. With an active command value limit, the set minimum command value is not undershot by command values. If the controller calculates smaller command values, it sets the configured minimum command value. The controller transmits a 0% command value if no more heating or cooling energy has to be demanded.

- **Maximum command value:**
The "Maximum command value" parameter specifies the upper command value limiting value. The setting can be made in 5 % increments in the range 55 % ... 100 %. With an active command value limit, the set maximum command value is not exceeded. If the controller calculates larger command values, it sets the configured maximum command value.

If the limit is removed, the device automatically repositions the most recently calculated command value to the unlimited values when the next calculation interval for the command values (30 seconds) has elapsed.

- i** If the device executes a valve rinsing function, the command value limit is temporarily deactivated in order to make use of the full motion range of the valve.
- i** An active command value limit has a negative effect on the control result when the command value range is very restricted. A control deviation must be expected.

Special case for command value 100% (Clipping mode)

If with a PI control the calculated command value of the controller exceeds the physical limits of the actuator, in other words if the calculated command value is greater than 100%, then the command value is set to the maximum value (100%) and thus limited. This special, necessary control behaviour is also called "clipping". With PI control the command value can reach the value "100%" if there is a large deviation of the room temperature from the setpoint temperature or the controller requires a long time to adjust to the setpoint with the heating or cooling energy that is being applied. The controller can evaluate this state in a particular manner and react to it in various ways.

The parameter "Behaviour with command value = 100% (clipping mode PI control)" on the parameter page "Room temperature control -> Controller general -> Command values and status output" defines the functions of the PI controller when the command value is 100%...

- "keep 100% until setpoint = actual, then 0%" setting:
The controller keeps the maximum command value until the room temperature (actual value) reaches the setpoint temperature. After that, it reduces the command value down to 0% all at once (controller reset).
The advantage of this control behaviour is that in this way sustainable heating up of undercooled rooms or effective cooling of overheated rooms will be achieved by overshooting the setpoint. The disadvantage is that in some circumstances the overshooting of the room temperature may be found disturbing.
- Setting "keep 100% as required, then adjust downwards":
The controller maintains the maximum command value only as long as it is necessary. After that, it adjusts the command value downwards according to the PI algorithm. The advantage of this control characteristic is the fact that the room temperature does not exceed the setpoint temperature at all, or only slightly. The disadvantage is that this control principle increases the tendency to oscillate about the setpoint.

Which of the methods of functioning described above is used often depends on what heating or cooling system is used (underfloor heating, radiators, fan coils, cooling ceilings, etc.), and how effective these systems are. We recommend selecting the setting "keep 100% until setpoint = actual, then 0%" (default setting). Only if this control behaviour has an adverse effect on the people's perception of the temperature in a room should the setting "keep 100% as required, then adjust downwards" be used.

- i** Clipping may also occur when a command value limit is active (maximum command value). In this case, if the internally calculated command value reaches 100%, then the controller only transmits to the bus the maximum command value according to the ETS configuration. The clipping (switching off when setpoint = actual or adjusting downwards) is performed, however.
- i** It should be noted that the clipping mode has no effect with "2-point feedback control"! In that case it is still possible to configure the parameter "Behaviour with command value = 100%" in the ETS, but it will have no function.

4.2.4.5.7 Fan controller

Operating mode and fan levels

The room temperature control can be supplemented with a fan controller. This makes it possible to control the fan from heating and cooling systems operated by circulating air, such as fan coil units (FanCoil units), depending on the command value calculated in the controller or using manual operation. If necessary, the fan controller can be enabled separately by setting the "Fan controller available" parameter in the "Room temperature control -> Controller general" parameter node to "Yes". When the function is enabled additional parameters will appear in the ETS in the "Room temperature control -> Controller general -> Fan controller" as well as additional communication objects.

- i** The fan controller works only in conjunction with PI feedback controls with continuous or switching (PWM) command value output. In 2-point feedback control, the fan controller is inactive, even if the function is enabled in the ETS.

Depending on the operating mode of the room temperature control, as configured in the ETS (see chapter 4.2.4.5.1. Operating modes and operating mode change-over) various controller command values can be used as the basis for fan control. The "Fan operating mode" parameter specifies which command value of the controller controls the fan controller. With one-level room temperature control, it is possible to select whether the fan is activated during heating and/or during cooling. With two-level room temperature control, it is also possible for the fan controller to be set to the basic level or the additional level during heating and cooling. However, under no circumstances is it possible to use the basic and additional levels simultaneously for a fan controller within an operating mode.

Fan coil units are as a rule equipped with filters, and have multi-level blowers whose speed and thus ventilation output can be varied by means of fan level inputs. For this reason, the fan controller of the room temperature controller supports up to 8 fan level outputs, for which the actually used number of levels (1...8) is set using the "Number of fan levels" parameter. The controller controls the levels of a fan using KNX telegrams. Usually, the fan level telegrams are received and evaluated by simple switching actuators. The electrical control of the fan level inputs of a fan coil unit takes place via these actuators. Depending on the data format of the objects of the controlled actuators, the change-over between the fan levels can either take place via up to 8 separate 1-bit objects or, alternatively, via one 1-byte object. The "Fan level change-over via" parameter defines the data format of the controller. With the 1-bit objects, each fan level discreetly receives its own object. With the 1-byte object, the active fan level is expressed by a value.

Fan level	Object value
Fan OFF	0
1	1
2	2
3	3
4	4
5	5
6	6
7	7
8	8

Table 12: Value meaning for 1 byte fan level object

Due to fan motors' inertia, as a rule there is a limit to how short the time intervals for switching the fan levels can be, i.e. there is a limit to how quickly the fan speed can be varied. Often, the technical information for a fan coil unit specifies change-over times that the fan convector must maintain for each fan level change-over. The change-over direction, i.e. whether the level is being increased or decreased, does not play any role here.

With a change-over via one of the 1-bit objects, when the fan level is changed by the controller, the active fan level is first switched off before the new level is switched on. If the fan controller is working in automatic mode, the settable "Waiting time on level change-over" is maintained on change-over of the levels. For this short time, the fan level objects all receive the status "0 - Fan off". A new level is only then switched on when the waiting time has elapsed. Only one fan level output is ever switched on (changeover principle).

With change-over via the 1-byte object, on changing the fan level, the change-over takes place directly into the new level, without setting the "OFF" status. If the fan controller is working in automatic mode, the settable "Waiting time on level change-over" (dwell time) is always taken into account before change-over of the levels. With rapid level change-over, the change to the new level only takes place once the waiting time has elapsed.

- i** The change from level 1 to OFF always takes place immediately, without a waiting time. An optionally-configured switch-on level is applied directly.
- i** In manual mode, the "Waiting time on level change-over" is only significant for the switch-on level (Start-up via level). Here, the fan levels can be switched over without a delay through manual operation.
- i** When changing from manual operation to automatic operation, the waiting time is taken into account in the case of a connected level change.

- i** The fans of a fan coil unit are - as described above - controlled by the fan level objects of the controller. The electromechanical valves for heating and/or cooling, integrated into the blower devices, can be activated via suitable switching actuators using the objects "Heating message" or (see page 87)"Cooling message".
- i** The 1-byte object "Ventilation visualisation" can, if necessary, also be evaluated by other KNX devices (e.g. visualisation - panel / PC software). It always transmit the current fan level as a 1-byte value, either automatically on a change or passively on reading out (value explanation according to Table 12).
- i** The objects of the fan levels are only updated by the controller. These objects may not be written to by other KNX subscribers. Reading out is possible.
- i** After a device reset, the fan level objects and the visualisation object are updated and the status transmitted to the KNX.

Automatic operation / manual operation

The fan controller distinguishes between automatic and manual operation. The change-over between the two operation modes takes place using the 1-bit object "Ventilation, auto/manual". The parameter "Interpretation object fan control automatic/manual" in the fan control parameter group defines with which switching value the automatic or manual operation is set via the communication object. Automatic mode is always active after a device reset.

- i** The "Ventilation, auto/manual" object transmits actively ("Transmit" flag set). When the operating mode is changed over using local control, the valid status is transmitted to the KNX.
- i** Updates to the object value "Automatic mode active" -> "Automatic mode active" or "Manual mode active" -> "Manual mode active" do not produce any reaction.

Automatic mode:

The command value of the controller is used internally in the device for automatic control of the fan levels. As a transition between the levels, there are threshold values, defined according to the command value of the controller, which can be set using parameters in the ETS. If the command value exceeds the threshold value of a level, the appropriate level is activated. If the command value sinks below a threshold value, minus the configured hysteresis, then the change-over takes place into the next lowest fan level. The hysteresis value applies to all the threshold values.

The threshold values for the individual fan levels can be parameterised freely in the range from 1 ... 99 %. The threshold values are not checked for plausibility in the ETS, meaning that incorrect parameterisation is possible. For this reason, it must be ensured that the threshold values, compared to the level value, are configured in a rising direction (level 1 threshold value > level 2 threshold value > level 3 threshold value > etc.).

When the command value changes, and thus the fan level, it is only possible to switch directly into neighbouring levels (exception: switch-on level). Thus, in Automatic operation, it is only possible, for example, to switch from level 2 down to level 1 or up to level 3. If the command value change exceeds or undershoots the threshold values of multiple fan levels, then, starting with the current fan level, all the fan levels are activated in succession until the fan level specified by the command value is reached.

If the fan is switched off by the automatic system, then it runs on for the time configured as "Fan run-on time, heating" or "Fan run-on time, cooling", providing that these run-on times are configured in the ETS.

- i** In automatic mode, the fan level objects are updated according to the internal command value calculation (cyclically every 30 seconds) plus the waiting time configured for level change-over. Telegram transmission only takes place when the object values of the fan levels are changed. After a device reset, the fan level objects are updated and the status transmitted to the KNX.
- i** If a switch-on level is configured in the ETS ("Start-up via level" parameter), then, before the automatic activation of a fan level, it is possible to switch to a level, specified in the ETS and usually higher, for a brief time according to the command value (see section "Switch-on level").
- i** The command value evaluated by the fan controller in Automatic mode can be optionally limited by in the top and bottom command value ranges by the parameters "Command value is 0% until internal command value is greater than" and "Command value is 100% as soon as internal command value is greater than". In addition, the command value can also be raised by a constant value by the "Command value offset" parameter Controller function - Fan control - Command value limit values and command value offset.

Manual operation:

With the local control of a button configured to "Function = Fan control" and "Button function = Manual control" on the device, the controller makes a distinction as to whether it was in automatic or manual mode at the time the button was pressed.

If the controller is in automatic mode, then pressing a button switches to manual mode. The parameter "Fan level on change-over to manual" then decides whether the fan level most recently set in automatic mode is maintained, the fan is switched off or a defined fan level is set (see also next section "Switch-on level").

If, at the time the button is pressed, the manual controller is already active, then the controller switches to the next highest fan level without a delay. If the fan is in the highest level, then pressing a button switches it back to the OFF level. From there, every additional press causes the fan level to be raised. The switch-on level is ignored.

If the fan is switched off manually from the highest level, then it runs on for the time configured as "Fan run-on time, heating" or "Fan run-on time, cooling", providing that these run-on times are configured in the ETS. If, during the run-on time, the manual control button is pressed again, the controller will terminate the run-on time. The fan switches off briefly and then switches immediately to level 1.

In fan control in the second operating level, the fan level and automatic mode can be set directly without taking into account the parameter "Fan level on change-over to manual", the switch-on

level or fan run-on times.

- i** The 1-bit object "Ventilation, auto/manual" only allows change-over between automatic and manual operation. It is not possible to switch the fan levels on using the object. This function is reserved solely for local control.
- i** Local actuation of a button configured to "Function = Fan control" and "Button function = Automatic" on the device deactivates manual operation and causes the controller to change over to automatic operation.
- i** When changing from manual operation to automatic operation, the waiting time configured in the ETS is taken into account in the case of a connected level change.
- i** The parameter "Fan level on change-over to manual" is not checked for plausibility in the ETS, meaning that an incorrect configuration is possible. For this reason, care should be taken to ensure that there is no level in the configuration which is higher than the actual fan levels. If a level which does not exist is to be configured for the change-over to manual control, then the fan controller changes over to the maximum possible level when changing over to manual operation.
- i** In manual operation, the switch-on level only functions in certain situations (see next section "Switch-on level").

Switch-on level

The fan can, if it was switched off before and should now start up, be switched on at a defined switch-on level. This switch-on level can be any of the available fan levels, and is set in the ETS using the "Start-up via level" parameter. The switch-on level is generally one of the higher fan levels of a fan coil unit, so that at the beginning of a heating or cooling process the fan can start up correctly (reliable start-up of the fan motor through transfer of a higher torque, and thus a higher fan speed).

The switch-on level remains active for the "Waiting time on level change-over" configured in the ETS. In automatic operation, the controller only switches to the fan level specified by the command value, when the waiting time has elapsed. There is no change-over if, after the waiting time has elapsed, the fan level specified by the command value equals the switch-on level.

- i** If the controlled fan requires a longer period of time for the start-up, then the waiting time in the ETS should be configured to higher values (possible time range 100 ms ... 25.5 s). It should be noted that the waiting time is also taken into account on each level change-over in automatic operation!

The switch-on level is always taken into account by the fan controller in automatic mode on switching the fan on (if it was previously switched off by the command value evaluation) and, in certain situations, after activation of manual operation. On changing over to manual operation, the behaviour of the fan depends on the settings of the parameter "Fan level on changing over to manual" and "Start-up via level" and the previous fan level in automatic operation as follows...

- If, due to the "Fan level on change-over to manual" parameter, a defined level from level 1 to level 8 is requested, the controller will set this level on activating manual operation. In this case, the parameter "Start-up via level" is not taken into account if the fan was most recently switched off in automatic operation.

- If, due to the "Fan level on change-over to manual" parameter, "Fan level OFF" is requested, the controller will switch the fan off during the change-over to manual operation. On subsequent pressing of the button for manual control, the "Start-up via level" parameter is taken into account and the switch-on level set. Then, the controller waits in this level until further manual operation.

 - If, due to the "Fan level on change-over to manual" parameter, no defined level is requested ("No change" setting) and the fan was switched off during automatic operation, then it will remain switched off on changing over to manual operation. On subsequent pressing of the button for manual control, the fan is switched to the first level. The "Start-up via level" parameter is thus not taken into account.
-
- i** A configured switch-on level is applied directly without a waiting time.
 - i** With a fan change-over via the 1-bit objects, when the fan level is changed by the controller, the active fan level is first switched off before the new level is switched on. In this case, the switch-off of a fan level and the subsequent changeover to a new fan level is not evaluated as a fan start-up, also meaning that the switch-on level is not set. In automatic operation, the switch-on level is only taken into account if the fan was switched off previously by the command value evaluation (command value < level 1 threshold value minus hysteresis) and then it is to start up using a new command value.
 - i** The start-up via the switch-on level also takes place after a change-over from manual operation to automatic operation, providing that the fan was most recently switched off in manual operation and, in automatic operation, a new command value requires the fan to be switched on.
 - i** The parameter "Start-up via level" is not checked for plausibility in the ETS, meaning that an incorrect configuration is possible. For this reason, care should be taken to ensure that there is no switch-on level in the configuration which is higher than the actual fan levels. The fan controller automatically corrects a faulty parameterisation by activating level 1 for the start-up, meaning that the fan starts up normally without a switch-on level.

Fan level limit

To reduce the fan noise of a fan coil, the fan level limit can be activated. The level limit reduces the sound emissions by limiting the maximum fan level to a fan level value specified in the ETS by the "Level limit" parameter (limit level). The limitation can be switched on and off via a 1-bit "Fan, level limit" object, and thus activated in accordance with requirements, for example via a timer during night-time hours in order to reduce noise in bedrooms, or via "manual" operation of a pushbutton when a "quiet room" is needed (auditorium or the like). The limitation of the fan level is activated by receipt of a "1" telegram via the object "Fan, level limitation". Deactivation is therefore achieved through the receipt of a "0" telegram.

While a limitation is active, the fan controller prevents the fan from being switched to a higher level than the limitation level. If, at the instant that the limit is activated, the fan is running at a level that is greater than the limit level, then the fan level is immediately reduced to the limitation value. In this case the switching sequence of the individual levels and the waiting time configured in the ETS are also taken into account in the level change-over.

The limitation level can be one of the available fan levels.

The level controller distinguishes between Automatic and Manual operation.

- i** The fan level limit overdrives the switch-on level. As a result, when the fan is switched on, if the limit is active, the level has an active limit and the switch-on limit is not started. In this case, the limit level is jumped to without waiting.
- i** The level limit has no effect with an activated fan forced position.

- i** The parameter "Level limit" is not checked for plausibility, meaning that an incorrect configuration is possible. For this reason, care should be taken to ensure that there is no limit level in the configuration which is higher than the actual fan levels. If a higher limit level is configured, then the limit has no effect.

Forced fan position

The controller provides the option of activating a forced fan position via the bus. With an active forced position, the fan levels can neither be controlled nor switched over in either automatic or manual mode. The fan remains in the forced state until the forced position is removed using the bus. In this manner, it is possible to switch the fan to a locked and controlled state, for example for servicing purposes.

As soon as a "1" telegram is received via the 1-bit object "Ventilation, forced position", the controller immediately sets the fan level configured in the ETS without delay. The fan can also be completely switched off. The only special feature when activating the forced position is the fact that the fan controller is in automatic operation and a waiting time elapses, due to a previous level change-over. In this case, the fan controller only switches to the forced position level without the waiting time elapsing.

The forced position is dominant. For this reason, it cannot be overdriven from automatic mode, manual mode, the level limit or fan protection. Only when the forced position is removed does the fan control begin to control the fan levels according to the active operating mode.

The removal takes place when a "0" telegram is received via the object "Ventilation, forced position". The fan always switches itself off first. In automatic operation, the controller then evaluates the active command value and, when the waiting time configured in the ETS has elapsed, switches to the required fan level, taking an optionally-configured switch-on level into account. In manual operation, the fan first remains switched off. The fan level is only raised when the manual control button is pressed again. If a switch-on level is configured, the controller will, when a button is pressed, switch to the switch-on level and remain there until further operation occurs.

- i** The parameter "Behaviour in a forced position" is not checked for plausibility, meaning that an incorrect configuration is possible. For this reason, care should be taken to ensure that there is no fan level in the configuration which is higher than the actual fan levels. If a higher level is configured for behaviour in a forced position than the number of fan levels, then the fan controller will start up the maximum possible level when the forced position is activated.
- i** The forced fan position does not influence the control algorithm integrated in the controller. The command values of the PI feedback control continue to be transmitted to the bus, even with a forced fan.

Command value limiting values and command value offset

In automatic operation, the command value of the controller is used internally in the device to control the fan levels, according to the fan operating mode. As a transition between the levels, there are threshold values, defined according to the command value of the controller, which can be set using parameters in the ETS. The evaluation of the controller command values can be specially influenced for automatic fan control.

The command value to be evaluated for the fan controller can be influenced by the "Command value is 0% until internal command value is greater than" parameter in the lower command value range. The fan controller only evaluates the command value according to the configured threshold values when the internal command value of the controller exceeds the configured limiting value. With smaller command values, the fan remains at a standstill.

Similarly, the command value to be evaluated for the fan controller can be limited by the "Command value is 100% as soon as internal command value is greater than" parameter in the upper command value range. In this case, the controller evaluates command values which exceed the configured limiting value as 100%. This means that the fan works at full power even with command values not at the maximum.

The "Command value offset" parameter allows configuration of a constant command value offset for the fan. The fan controller always adds the configured offset to the command value to be evaluated. The effect of this is that the fan turns at greater power than required by the command value, according to the threshold values. The result of this is that, even if the command value is switched off, the fan will continue to work when the first command value threshold value is exceeded by the offset.

- i** A configured command value offset cannot not affect a command value of greater than 100%. The maximum command value of the fan controller is therefore defined as 100 %.

Fan protection

The fan protection function allows the fan of a fan coil unit, which has not been active for some time, to be temporarily switched to the maximum level. In this way, the controller fan motors can be protected against stiffness. In addition, the fan blades and the heat exchanger of the fan coil unit are protected against dust against dust.

If the fan protection is to be used, it must be enabled using the parameter of the same name in the ETS. Fan protection can then be activated or deactivated directly using the 1-bit communication object "Ventilation, fan protection", for example using a KNX/EIB time switch.

If the fan protection object has the switching value "1", then the fan protection function is active. The fan then works at the highest possible fan level and overdrives automatic and manual operation. Fan protection can then be switched off again using the "0" switching value in the communication object.

The reaction of the fan to switching fan protection depends on the operating mode of the automatic fan system. In automatic operation, the fan switches back to the level determined by the command value of the room temperature control. In manual operation, the fan switches off and can then be switched on again by additional manual actuation. The "Start-up via level" parameter is taken into account here.

- i** Even if the fan controller is inactive due to the controller operating mode, it is possible to activate the fan using fan protection.
- i** With an active level limit, the maximum fan level of fan protection is specified by the limit level.
- i** For reasons of safety, fan protection is not carried out with an active forced position.
- i** If fan run-on times are configured in the ETS, then the fan is switched off after a delay when fan protection is deactivated.

4.2.4.5.8 Disable functions of the room temperature controller

Certain operation conditions may require the deactivation of the room temperature control. For example, the controller can be switched-off during the dew point mode of a cooling system or during maintenance work on the heating or cooling system. The "Via object" setting in the "Switch off controller (dew point operation)" parameter in the "Room temperature control -> Controller functionality" parameter node enables the 1-bit "Disable controller" object. In addition, the controller disable function can be switched off when set to "No".

In case a "1" telegram is received via the enabled disable object, the room temperature control will be completely deactivated. In this case, all command values are equal "0" (wait 30 s for update interval of the command values). The controller, however, can be operated in this case.

The additional stage can be separately disabled when in two-stage heating or cooling mode. When set to "Yes", the "Additional level disabling object" parameter in the "Room temperature control -> Controller general" parameter node will enable the 1 bit "Disable additional level" object. In addition, the disable function of the additional level can be switched off when set to "No". In case a "1" telegram is received via the enabled disable object, the room temperature control is completely deactivated by the additional level. The command value of the additional level is "0" while the basic level continues to operate.

- i** A disable is always deleted after a reset (return of bus voltage, ETS programming operation).

4.2.4.6 Temperature limiting value

The device can monitor temperature values (only as of application program version "1.2"). The parameter "Limiting value monitoring" on the parameter page "Temperature limiting value" enables the limiting value monitoring of a temperature value and determines which temperature value is monitored. The temperature values "Remote sensor measured value", "Internal sensor measured value" or "Temperature measurement actual temperature value" can be monitored. The parameter "Limiting value monitoring" is not checked for plausibility. For this reason, make sure that the parameterised object is actually enabled. The objects are enabled depending on the setting of the parameters "Function input" (parameter page "Input") and "Temperature detection by" (parameter page "Room temperature measurement").

i For a functioning limiting value monitoring, the selected object must actually be enabled.

The parameters "Limiting value (°C)" and "Hysteresis (K)" define the temperature limiting value. The temperature limiting value must be exceeded or undershot so that the communication object "G.Output temperature limiting value" can optionally send a telegram to the KNX. The parameter "Limiting value function" defines whether the KNX telegram is transmitted when the value is exceeded or undershot.

The data format of the communication object "G.Output temperature limiting value" can be defined as a 1-bit object or as a 1-byte object. The 1-bit limiting value object sends a "1" or a "0" to the KNX according to the defined thresholds. The 1-byte limiting value object sends configurable values between 0 and 255 to the KNX according to the defined thresholds. These values define the parameters "Value at ON" and "Value at OFF".

Two delay times can be configured for the limiting value monitoring. Only after the configured delay times have elapsed the current state of the limiting value be accepted in the limiting value object. The switch-on delay defines the delay time for a change of the limiting value from "0" to "1" and the switch-off delay defines the delay time for a change of the limiting value from "1" to "0". The value of the limiting value object can be transmitted to the KNX during change or cyclically.

i If the parameter "Limiting value function" for a condition is set to "No telegram", then the cyclical telegrams are also suppressed when the set condition is fulfilled.

i If the parameter "Transmission on change" is set to "No" and the parameter "Cyclical transmission (x 10 seconds)" is set to "0", then the limiting value is not transmitted at all.

Among other things, the limiting value monitoring can be used for:

- Alerting when the temperature exceeds or falls below the limiting temperature
- Activation of a fan when a limiting temperature is exceeded
- Activation of a circulation pump at low return flow temperature and switching-off of the pump as soon as the return flow temperature has reached the limiting value

4.2.5 Parameters

4.2.5.1 General

Description	Values	Comment
<input type="checkbox"/> General		
Telegram rate limit	Disabled enabled	This parameter deactivates or activates the telegram rate limit.
Telegrams per 17 s	30 Telegrams per 17 s 60 Telegrams per 17 s 100 Telegrams per 17 s 127 Telegrams per 17 s	This parameter specifies the maximum telegram rate. Within 17 seconds, the designed number of telegrams can be transmitted at most. The setting can only be employed if the telegram rate limit is enabled.

4.2.5.2 Valve drive

Description	Values	Comment
<p>☐ Valve drive</p> <p>Actuation of the valve drive via</p>	<p>Object value</p> <p>Internal command value for heating / basic heating / heating and cooling of the controller</p> <p>Internal command value for cooling / basic cooling of the controller</p> <p>Internal command value additional heating of the controller</p> <p>Internal command value additional cooling of the controller</p>	<p>Only as of application program version "1.2".</p> <p>The valve drive infinitely implements received command values. The presetting of the command values can be set via a communication object or internally from the room temperature controller.</p> <p>If "Object value" is selected, the valve drive operates with command values which are received by the valve drive via the communication object "V.Command value". Then the parameter "Command value is received as" according to the output format of the controller.</p> <p>The settings "Internal command value ..." define that the presetting of the command values is made internally by the room temperature controller. The parameter "Command value is received as" is automatically set in accordance with the configured control type (parameter page "Room temperature controller" -> "Controller general").</p> <p>i The settings of the parameters "Valve drive control via" and "Operating mode" (parameter page "Controller general") must be adjusted to each other.</p>
<p>Operating mode</p>	<p>Normal (command value 0% -> valve closed)</p> <p>Inverse (command value 0% -> valve open)</p>	<p>This parameter assigns the command value to the valve position.</p> <p>In the "Normal (command value 0% -> Valve closed)" setting, the valve is closed at the command value 0% (0% = Closed; 100% = Open).</p> <p>The valve is opened at the command value 0%, if the parameter is set to "Inverse (command value 0% -> Valve opened)" (0% = Open; 100% = Closed).</p>
<p>Default position, command value during initialisation</p>	<p>0 % (Caution! No frost protection)</p> <p>10%</p> <p>20%</p> <p>30%</p> <p>40%</p>	<p>The default position is that plunger position which is automatically set by the valve drive after a successfully completed self-adjustment if the valve drive has not received a command value telegram during the self-adjustment.</p> <p>If emergency operation is not to be</p>

	<p>50%</p> <p>60%</p> <p>70%</p> <p>80%</p> <p>90%</p> <p>100%</p>	<p>performed using the internal temperature sensor and controllers, then the parameter "Default position, command value on initialisation" defines the fixed valve position to be approached during active emergency operation.</p>
Command value monitoring	<p>No</p> <p>Yes</p>	<p>Here, cyclical monitoring of the command values can be enabled as an option ("Yes" setting). If, during active cyclical monitoring, there are no command value telegrams during the monitoring time defined by the parameter of the same name, emergency operation will be activated. Monitoring of the command value telegrams is only possible when the room temperature controller function has been switched off. Accordingly, this parameter is only visible if the parameter "Room temperature controller function" is set to "Switched off".</p>
Monitoring time		<p>This parameter specifies the monitoring time of the command value monitoring. The valve drive must receive at least one command value telegram within the time frame preset here. If there is no command value telegram, then the valve drive will assume a fault and will activate emergency operation. This parameter is only available when monitoring is enabled.</p>
minutes	<p>0 ... 10 ... 255</p>	<p>presetting of the monitoring time minutes.</p>
Emergency operation	<p>Default position</p> <p>With internal temperature sensor and controller</p>	<p>This parameter defines the behaviour of the device if the device does not receive a valid command value telegram during the monitoring time. In the standard project design, the valve drive moves its plunger to the designed default position in active emergency operation. Optionally, in emergency operation, the valve drive can also be operated with values of the internal temperature sensor and the internal controller. In emergency operation is set with an internal temperature sensor and controller, three parameters of the room temperature controller become visible on the "Controller, emergency operation" parameter page. These</p>

parameters should be designed orientated to the system for emergency operation.
All the other parameters of the room temperature controller are not displayed in the database. They are loaded into the device with their standard values during a programming operation (see chapter 4.2.5.5. Room temperature controller).

i The room temperature controller has no communication objects for emergency operation. When emergency operating is active, the valve drive is internally linked in the device with the external room temperature controller.

Start self-adjustment in dependence on the number

of received command value telegram
of command value changes

This parameter defines through which event the internal meter is increased up to the next self-adjustment. The number of events is preset to 4096. The value can be calibrated using the parameter "Number of motor movements / object values until new adjustment". Self-adjustment of the valve drive takes place either after the defined number (default = 4096) of received command value telegrams or command value changes, in which case the received command value telegrams are insignificant.

☐ Controller, emergency operation

Only visible if: "Room temperature controller function" is switched off, "Command value monitoring" is set to Yes and "Emergency operation" is carried out with an internal temperature sensor and controller.

Operating mode

Heating
Cooling

This parameter specifies the operating mode of the room temperature controller during active emergency operation. There is the option of choosing between the "Heating" or "Cooling" operating modes. The operating modes specify whether you want the controller to use its variable to trigger heating systems ("heating" single operating mode) or cooling systems ("cooling" single operating mode).

i During emergency operation, it is not possible to activate mixed operation.

i Two-level control is also not possible during emergency operation.

Type of heating	<p>Hot water heater (5 K / 150 min)</p> <p>Underfloor heating (5 K / 240 min)</p> <p>Electric heating (4 K / 100 min)</p> <p>Fan convector (4 K / 90 min)</p> <p>Split unit (4 K / 90 min)</p>	<p>This parameter is used for adapting the PI algorithm to different heating systems using predefined values for the "Proportional range" and "Reset time" control parameters.</p> <p>This parameter is only visible if the operating mode for emergency controller operation is set to Heating.</p>
Type of cooling	<p>Cooling ceiling(5 K / 240 min)</p> <p>Fan convector(4 K / 90 min)</p> <p>Split unit(4 K / 90 min)</p>	<p>Adapting the PI algorithm to different cooling systems using predefined values for the proportional range and reset time control parameters.</p> <p>This parameter is only visible if the operating mode for emergency controller operation is set to Cooling.</p>
Setpoint temperature (°C)	7 ... 21 ... 40	<p>This parameter defines the temperature value to which the device should regulate during active emergency operation.</p>
<input type="checkbox"/> Valve rinsing		
Use function "Valve rinsing" ?	<p>Yes</p> <p>No</p>	<p>The automatic valve rinsing function can be used to prevent calcification or sticking of a valve which has not been activated for some time. Valve rinsing can be executed cyclically or using a KNX command, causing the activated valve to run through the full valve stroke for a preset period of time.</p> <p>During valve rinsing, the valve drive activates a command value of 100 % without interruption for the valve for the "Valve rinsing time". For this, the valve opens completely.</p> <p>After the time has elapsed, valve rinsing stops. The valve drive moves back to that command value active before valve rinsing.</p> <p>In the "Yes" setting, this parameter enables valve rinsing.</p>
Length of valve rinsing		<p>Here, preset for how long the rinse function is to be executed. Set the</p>

		length of the valve rinsing in such a way that the valve can open completely. This is usually guaranteed by configuring the rinsing length to double the adjustment cycle time. This parameter is only available if valve rinsing is enabled.
Minutes	0 ... 5 ... 59	This parameter defines the length of the valve rinsing in minutes.
Activate cyclical valve rinsing ?		The device can perform valve rinsing cyclically, if necessary. When using the cyclical valve rinsing, a rinse operation can be started automatically after a configurable cycle time (1...26 weeks). Here too, the valve rinsing length configured in the ETS defines the time for the once-only complete opening of the activated valves. At the end of a rinsing operation, the valve drive always restarts the cycle time. This parameter is only available if valve rinsing is enabled.
	Yes	Cyclical valve rinsing is enabled. Each ETS programming operation resets the cycle time. The first rinsing operation with cyclical valve rinsing takes place after an ETS programming operation after the first time cycle has elapsed. A bus voltage failure immediately interrupts an active rinsing operation. When the bus/mains voltage returns, a previously interrupted rinsing operation is not executed again. The device then starts a new time cycle for cyclical valve rinsing.
	No	Cyclical valve rinsing is completely disabled. Valve rinsing can only be started by the communication object (if enabled).
Time object	Yes	This parameter makes the appropriate communication object visible to prevent cyclical valve rinsing at night. The valve drive possesses an internal clock. This checks, in a 24-hour cycle, the designed cycle time in weeks. After the projected cycle time has elapsed, the device begins cyclical valve rinsing.
	No	
		<u>Yes setting:</u> The 3-byte communication object "V.Time" is visible for specifying the current time. Cyclical valve rinsing

begins at 10:00 a.m. at the earliest and at 6:00 p.m. at the latest. The internal clock of the device runs with a small gait deviation, which increases over time. For this reason, the internal clock should be synchronised with the KNX on a regular basis.

No setting: The 1-byte communication object "V.Day / Night" is visible for specifying the time. A KNX telegram tells the device whether it is day ("1") or night ("0"). If cyclical valve rinsing is to be performed during a night phase, then this is suppressed until this communication object receives a "1" telegram for day. Cyclical valve rinsing is carried out as planned as soon as the device is back in a day phase.

Cycle time

This parameter defines how often cyclical valve rinsing is to be performed automatically. This parameter is only available if cyclical valve rinsing is enabled.

Weeks

0 ... **4** ... 26

This parameter defines the cycle time of the cyclical valve rinsing in weeks.

Use intelligent valve rinsing ?

Yes
No

Optionally, intelligent cyclical valve rinsing can be additionally activated here. Here, valve rinsing is only executed repeatedly, if, in the current time cycle, a configured minimum command value limiting value was not exceeded. If the active command value exceeds the limiting value, the device will stop the cycle time. The device only restarts the cycle time if, in the further course of the command value change, a command value of "0 %" or "OFF" (completely closed) is set. This prevents valve rinsing if the valve has already run through a sufficiently defined stroke. If, after exceeding the configured limiting value, the value was not completely closed at least once (command value "0 %" or "OFF"), then no further cyclical valve rinsing will take place. This parameter is only available if cyclical valve rinsing is enabled.

Limiting value minimum command value for intelligent valve rinsing

10%
20%
30%
40%

This parameter defines the minimum command value limiting value of the intelligent valve rinsing. Intelligent valve rinsing is only executed repeatedly, if, in

	50% 60% 70% 80% 90% 100%	the current time cycle, a minimum command value limiting value configured here was not exceeded. If the active command value exceeds the limiting value, the device will stop the cycle time. This parameter is only available if cyclical valve rinsing is enabled.
Valve rinsing activated externally ?	Yes No	If necessary, valve rinsing can be started and, optionally, stopped using the input communication object "V.Valve rinsing start". This means that it is possible to activate a rinsing operation of the valve controlled by time or an event. The KNX control can only be used if it has been enabled here. This parameter is only available if valve rinsing is enabled.
Polarity object, "Start valve rinsing"	0 = Stop / 1 = Start 0 = Start / 1 = Stop 0,1=Start (Stop not possible)	This parameter sets the telegram polarity of the object for external valve rinsing. When a start command is received, the device immediately starts the configured time for a rinsing operation. The device also actively executes valve rinsing if no higher-priority function is active. If object-controlled stopping is permitted, then the actuator will also react to Stop commands by immediately interrupting running rinsing operations.
<input type="checkbox"/> Extended		
Command value is received as	8-bit value 1-bit switching function	The value of this parameter is permanently set accordance with the configured control type (parameter page "Room temperature controller" -> "Controller general") if the parameter "Valve drive control via" is set to an internal command value. This parameter can be configured if the parameter "Valve drive control via" is set to "Object value". The valve drive receives 1-bit or 1-byte command value telegrams, transmitted, for example, by KNX room temperature controllers. Usually, the room temperature controller determines the room temperature and generates the command value telegrams using a control algorithm. The valve drive controls its plunger according to the data format of the command values and the configuration in the ETS. The

		<p>communication object "V.Command value" is enabled in the appropriate data format.</p> <p>In the case of a 1-bit command value, the telegram received via the command value object is forwarded, taking the configured operating mode into account. The following parameters define the command value to be set if an "ON" or "OFF" telegram is received.</p> <p>i This parameter is not visible if the parameters "Valve drive control via" (parameter page "Valve drive") and "Operating mode" (parameter page "Controller general") are not adjusted to each other.</p>
Command value for object value 0 (%)	0 ... 20 ... 100	<p>The set value defines the valve position to be approached when the object value "0" is received via the KNX. This parameter is only available when the command value is transmitted as a 1-bit switching function.</p>
Command value for object value 1 (%)	0 ... 80 ... 100	<p>The set value defines the valve position to be approached when the object value "1" is received via the KNX. This parameter is only available when the command value is transmitted as a 1-bit switching function.</p>
Object transmits "Actual position"	<p>Actual valve position</p> <p>linearised actual position</p>	<p>In the "Actual valve position" setting, the actual position (0...100% = 0...255) is transmitted as the actual value. In the "Linearised actual position" setting, the position is transmitted, taking the characteristic curve adjustment into account.</p>
Valve type	<p>Standard valve</p> <p>Optimised for Heimeier standard to 1/2"</p> <p>User-defined valve</p>	<p>This parameter adapts the device to the connected valve.</p> <p>Standard valve: The characteristic curve data of the valve type "Standard valve" correspond to a linear characteristic curve, meaning that the received command value corresponds to the actual valve position to be set and the linearised actual position.</p> <p>Optimised for Heimeier standard up to 1/2": The characteristic curve of the valve type (Optimised for Heimeier standard up to 1/2") achieves a more rapid increase of the actuating valve</p>

		relative to the setpoint with setpoint specifications in the range 0...10%.
		User-defined valve: Access to the user-defined valve settings is only intended for the manufacturer and specially-trained people. In the "User-defined valve" setting, a further parameter becomes visible.
Release code to adapt valve parameters	0000 ... 9999	Access to the user-defined valve settings is only intended for the manufacturer and specially-trained people and is gained by entering a fixed numeric code.
□ Forced position		
Activate forced position 1	Forced position inactive Active at object value 1 Active at object value 0	This parameter defines whether, and, if yes, upon which object value, the forced position 1 is set.
Command value for forced position 1	0 % (Caution! No frost protection) 10% 20% 30% 40% 50% 60% 70% 80% 90% 100%	If forced position 1 is activated, the valve is moved to the percentage value chosen here.
Duration of 0% phase with active forced position 1		This parameter specifies the length of the 0% phase, during which the valve first closes completely after activation of forced position 1. Only then is the actual value set for forced position 1.
Hours	0 ... 8	This parameter specifies the length of the 0% phase in hours.
Minutes	0 ... 59	This parameter specifies the length of the 0% phase in minutes.
Activate forced position 2	Forced position inactive Active at object value 1	This parameter defines whether, and, if yes, upon which object value the forced position 2 is set.

Command value for forced position 2	<p>Active at object value 0</p> <p>0 % (Caution! No frost protection)</p> <p>10%</p> <p>20%</p> <p>30%</p> <p>40%</p> <p>50%</p> <p>60%</p> <p>70%</p> <p>80%</p> <p>90%</p> <p>100%</p>	If forced position 2 is activated, the valve is moved to the percentage value chosen here.
Duration of 0% phase with active forced position 2		This parameter specifies the length of the 0% phase, during which the valve first closes completely after activation of forced position 2. Only then is the actual value set for forced position 2.
Hours	0 ... 8	This parameter specifies the length of the 0% phase in hours.
Minutes	0 ... 59	This parameter specifies the length of the 0% phase in minutes.
Highest priority	<p>Forced position 1</p> <p>Forced position 2</p>	This parameter defines the forced position with the higher priority for the case that both forced positions are active simultaneously.
Behaviour at end of forced position	<p>Waiting for next setpoint</p> <p>Move to last setpoint</p>	This parameter defines the behaviour of the device after termination of the forced position.
<p><input type="checkbox"/> Limit</p> <p>Activation min. limit</p>	<p>Limiting inactive</p> <p>Active at object value 0</p> <p>Active at object value 1</p> <p>Always active</p>	This parameter enables the minimum limit of the command value. In so doing, it defines using which object value the minimum limit is activated or whether it is always active.
Minimum command value limit	<p>0 % (Caution! No frost protection)</p> <p>10%</p> <p>20%</p> <p>30%</p>	This parameter specifies the value of the minimum command value limit.

	40%	
	50%	
Activation max. limit	Limiting inactive	This parameter enables the maximum limit of the command value. In so doing, it defines using which object value the maximum limit is activated or whether it is always active.
	Active at object value 0	
	Active at object value 1	
	Always active	
Maximum command value limit	55%	This parameter specifies the value of the maximum command value limit.
	60%	
	70%	
	80%	
	90%	
	100%	
□ Limiting value		
Limiting value	0%	This parameter specifies the value of the valve position, which must be exceeded or fallen below for the communication object "V.Limiting value" to send a "1" telegram to the KNX as an option. The parameter "Limiting value message" defines whether the KNX telegram is transmitted when the value is exceeded or fallen below.
	10%	
	20%	
	30%	
	40%	
	50%	
	60%	
	70%	
	80%	
	90%	
	100%	
Limiting value message	DO not transmit	This parameter defines whether a limiting value message is transmitted to the KNX. A limiting value message can be output either when the value defined by the parameter "Limiting value" is exceeded or fallen below.
	"ON" telegram if exceeded	
	"ON" telegram if fallen below	
□ Fault message		
Fault message	DO not transmit	The parameter "Fault message" enables a communication object. A "1" telegram is optionally sent via the object "V.Fault" if there is an adjustment error, during adjustment operation or on a controller timeout. After the fault has been eliminated, the communication object "V.Fault" transmits a "0" telegram to the KNX.
	"ON" telegram for adjustment error	
	"ON" telegram for adjustment mode	
	"ON" telegram for controller timeout	
□ Valve parameters		
This parameter page is only visible if, on the "Advanced" parameter page, the selection "User-		

defined valve" was selected under "Valve type" and the correct enabling code was entered. Access to the user-defined valve settings is only intended for the manufacturer and specially-trained people and is gained by entering a fixed numeric code.

Min. absolute setpoint change for addressing the drive	0 ... 2 ... 255	Minimum necessary change to the emergency value, leading to a movement of the drive. This means that, for example, deviations in the command value by a level, which can occur during the A/D conversion in the temperature sensor through tipping of the lowest-value bit, can be caught.
Measurement delay (ms)	0 ... 100 ... 65535	Waiting time, after which the current measurements can be performed after starting the motor. Avoidance of "incorrect measurements", as the start-up current is not measured here.
Limiting value for point OA	150	Current limiting value for the detection of the top stop (OA) of the valve drive. Reference point for further measurements, e.g. stroke check. The parameter value is proportional to the measured current. The limiting value for the OA point is fixed to 150.
Start-up pulse	0 ... 5 ... 65535	This parameter defines the minimum number of pulses which occur until the top stop (OA) in the drive is reached. If the top stop is not reached with the defined number of start-up pulses, then the drive will move back a bit before recommencing adjustment in the direction of the top stop.
Pause time for direction change (ms)	0 ... 1500 ... 65535	Here, a pause time is defined in milliseconds which should elapse before the valve drive motor starts in the opposite direction. The time is observed for each direction change of the motor (e.g. during self-adjustment).
Delta pulse rate for point D	0 ... 77 ... 65535	Specification of the reference points for current measurement. The reference points are used to determine a reference current. After the start of an adjustment from the top stop towards the closing point, the device measures the current as a reference value. Here, it is possible to set after which quantity of pulses the reference value for the current is

		measured, in order to determine the closing point.
Stroke check point OA - > C	0 ... 160 ... 65535	If the number of counted light barrier pulses between the top stop of the valve drive (OA) and the closing point of the valve (C) is greater than the value entered here, then this is evaluated as an error and adjustment is terminated. If this value is set too high, then the piston may become loose if there is no valve and fall out of the drive.
Delta current value for point C	0 ... 60 ... 65535	Current limiting value for the detection of the closing point C of the valve. The closing point is determined when the measured current of the drive motor reaches the total of a determined reference current and the "Delta current value for point C".
Delta pulse rate for point E	0 ... 13 ... 65535	Specification of the reference points for current measurement. The reference points are used to determine a reference current. After the start of an adjustment from the top stop towards the closing point, the device measures the current as a reference value. Here, it is possible to set after which quantity of pulses the reference value for the current is measured, in order to determine the closing point.
Maximum valve stroke	0 ... 75 ... 65535	If, during adjustment, the measured stroke is greater than the configured maximum valve stroke, then this is evaluated as an error.
Delta current value for point B	0 ... 30 ... 65535	Current limiting value for the detection of the opening point B of the valve. The opening point is determined when the measured current of the drive motor reaches the total of a determined reference current and the "Delta current value for point B". The opening point is the point at which the piston leaves the spindle.
Minimum valve stroke	0 ... 26 ... 65535	If, during adjustment, the measured stroke is smaller than the configured minimum valve stroke, then this is evaluated as an error.

Limiting value for 0	0 ... 2 ... 255	Received command value telegrams, which are smaller than the value set here, are interpreted as 0 (0...255 -> 0...100%).
Number of motor movements / object values until new adjustment	0 ... 4096 ... 65535	After a defined number of motor movements or received command value telegrams, the valve drive restarts self-adjustment.
State timeout (s)	0 ... 200 ... 65535	This parameter defines the maximum length in seconds in which the valve drive may remain in a calibrated state (open or close). If this time is fallen below, then the valve drive assumes an error and self-adjustment of the drive is performed again.
Delta pulse rate for point V	0 ... 4 ... 65535	Specification of the reference points for current measurement. The reference points are used to determine a reference current. After the start of an adjustment from the top stop towards the closing point, the device measures the current as a reference value. Here, it is possible to set after which quantity of pulses the reference value for the current is measured, if the piston is located between the top stop and contact with the valve spindle.
Delta current value for seal	0 ... 20 ... 65535	This parameter defines the current value for detecting the area of the valve seal. The current value must exceed the reference value at point D by the value set here, so that the device can recognise the start of the valve seal area.
Delta current value for plunger	0 ... 20 ... 65535	This parameter defines the current value for detecting the piston. The current value must exceed the reference value at point V by the value set here, so that the device can recognise contact with the piston.
First support point, setpoint	0 ... 255	For characteristic curve adjustment: Specification of the appropriate setpoints for the characteristic curve (X

		axis)
Second support point, setpoint	0 ... 80 ... 255	For characteristic curve adjustment: Specification of the appropriate setpoints for the characteristic curve (X axis)
Third support point, setpoint	0 ... 160 ... 255	For characteristic curve adjustment: Specification of the appropriate setpoints for the characteristic curve (X axis)
Fourth support point, setpoint	0 ... 255	For characteristic curve adjustment: Specification of the appropriate setpoints for the characteristic curve (X axis)
First support point, actuating value	0 ... 255	For characteristic curve adjustment: Specification of the appropriate actuating values for the characteristic curve (Y axis)
Second support point, actuating value	0 ... 80 ... 255	For characteristic curve adjustment: Specification of the appropriate actuating values for the characteristic curve (Y axis)
Third support point, actuating value	0 ... 160 ... 255	For characteristic curve adjustment: Specification of the appropriate actuating values for the characteristic curve (Y axis)
Fourth support point, actuating value	0 ... 255	For characteristic curve adjustment: Specification of the appropriate actuating values for the characteristic curve (Y axis)

4.2.5.3 Input

Description	Values	Comment
<p>☐↵ Input</p> <p>Function input</p>	<p>No function</p> <p>Switching</p> <p>Dimming</p> <p>Venetian blind</p> <p>Dimming value transmitter</p> <p>Light scene extension without memory function.</p> <p>Light scene extension with memory function</p> <p>Temperature value transmitter</p> <p>Brightness value transmitter</p> <p>Remote sensor</p> <p>Temperature limiter underfloor heating</p>	<p>This parameter defines the basic function of the binary input. In the "no function" setting, the input is deactivated. Depending on the selected function, other parameters and parameter pages are enabled.</p>
<p>Delay after reset or when bus voltage returns</p>		<p>This parameter defines the delay after a reset or bus voltage return in minutes and seconds. This transmission delay only takes effect for automatically transmitting objects of the device after bus voltage return. The delay after a reset or a bus voltage return applies to almost all the functions of the input. An exception to this are the functions: "Remote sensor" and "Temperature limiter, underfloor heating". Accordingly, this parameter can be seen on the "Input" parameter page.</p>
<p>minutes</p>	<p>0 ... 255</p>	<p>This parameter defines the minutes of the delay time.</p>
<p>Seconds</p>	<p>0 ... 255</p>	<p>This parameter defines the seconds of the delay time.</p>
		<p>The device - depending on configuration - has various feedback objects. These objects can be configured as "actively transmitting" so that a feedback telegram can be transmitted</p>

automatically to the KNX when the state changes. These objects then transmit the current object value constantly even after bus voltage return in order to initialise other KNX subscribers. A high telegram load can result after bus voltage return, particularly in large KNX systems with many sensors. To counteract such an overload, a transmission delay after bus voltage return is configurable here.

☐ Switching

Debounce time

This parameter specifies the software debouncing time. Depending on the quality of the connected contacts, you can define here after which actuation period the binary input detects a valid actuation.

Milliseconds

10 ... **30** ... 255

This parameter specifies the software debouncing time in milliseconds.

Command on rising edge
Switching object 1.1

No reaction
On
Off
Toggle

This parameter can be used to define which object value is transmitted first to the KNX via the first communication object of the input when there is a rising edge (TOGGLE - switchover of the object value).

Command on falling edge
Switching object 1.1

No reaction
On
Off
Toggle

This parameter can be used to define which object value is transmitted first to the KNX via the first communication object of the input when there is a falling edge (TOGGLE - switchover of the object value).

Command on rising edge
Switching object 1.2

No reaction
On
Off
Toggle

This parameter can be used to define which object value is transmitted first to the KNX via the second communication object of the input when there is a rising edge (TOGGLE - switchover of the object value).

Command on falling edge
Switching object 1.2

No reaction
On
Off
Toggle

This parameter can be used to define which object value is transmitted first to the KNX via the second communication object of the input when there is a falling edge (TOGGLE - switchover of the object value).

Response to bus voltage return

After a device reset (bus voltage return or ETS programming operation), the communication objects of the input can be initialised. If, in the ETS, a delay is set for the input after bus voltage return, the device only transmits the telegrams when the delay has elapsed.

No reaction

After a device reset, no reaction takes place automatically (no telegram is transmitted to the KNX).

Send ON telegram

In this configuration, an "ON" telegram is actively transmitted to the KNX after a device reset.

Send OFF telegram

In this configuration, an "OFF" telegram is actively transmitted to the KNX after a device reset.

Transmit current input status

In this setting, the device evaluates the static signal status of the input and, according to this, transmits the appropriately configured telegram to the KNX (contact closed at the input = telegram as with rising edge; contact open at input = telegram as with falling edge). If, in this case, the edge command dependent on the current status is configured to "No reaction", the device does not transmit a telegram to the bus on initialisation.

Cyclical transmission (switching)

Cyclical transmission switching object 1.1

Optionally, the object values can be transmitted cyclically to the KNX for the "Switching" function. For this, the transmission criteria must first be defined in the ETS. This parameter specifies with which value cyclical transmission should take place. The object value entered in the switching objects by the device on a edge change or externally by the KNX is always transmitted cyclically. The object value is then also transmitted cyclically when "no reaction" is assigned to a rising or falling edge. Cyclical transmission also takes place directly after bus voltage return, if the reaction after bus voltage return corresponds to the transmission criterion for cyclical transmission. During an active disable, no cyclical transmissions take place via the disabled input.

	no cyclical transmission	There is no cyclical transmission.
	Repeat on ON	Transmission takes place cyclically when the object value is "ON".
	Repeat on OFF	Transmission takes place cyclically when the object value is "OFF".
	Repeat on ON and OFF	Transmission takes place cyclically irrespective of the object value.
Cyclical transmission, switching object 1.2	no cyclical transmission	(See parameter "Cyclical transmission Switching object 1.1")
	Repeat on ON	
	Repeat on OFF	
	Repeat on ON and OFF	
<input type="checkbox"/> Disable (switching)		
Disabling function switching object 1.1	Disabled enabled	The inputs can be separately disabled via the KNX using 1-bit objects. With the "Switching" function, it is possible to disable the two switching objects of an input independently of each other. With an active disabling function, signal edges at the input are ignored by the device related to the affected objects. This parameter enables the disabling function of the first communication object.
Polarity of the disabling object	Disable = 0 (Enable = 1) Disable = 1 (Enable = 0)	This parameter defines the polarity of the disabling object.
Behaviour at the beginning of the disabling function switching object 1.1	No reaction On Off Toggle	With an active disable, the first switching object is disabled. This parameter specifies the command transmitted via this object at the beginning of the disabling. "TOGGLE" switches over the current object value.
Behaviour at the end of the disabling function switching object 1.1	No reaction On Off Transmit current input status	With an active disable, the first switching object is disabled. This parameter specifies the command transmitted via this object at the end of the disabling. In the "Transmit current input status" setting, the device evaluates the current static signal status of the input and, according to this, transmits the appropriately configured telegram to the KNX (contact closed at the input =

		telegram as with rising edge; contact open at input = telegram as with falling edge).
Disabling function switching object 1.2	Disabled enabled	The inputs can be separately disabled via the KNX using 1-bit objects. With the "Switching" function, it is possible to disable the two switching objects of an input independently of each other. With an active disabling function, signal edges at the input are ignored by the device related to the affected objects. This parameter enables the disabling function of the second communication object.
Polarity of the disabling object	Disable = 0 (Enable = 1) Disable = 1 (Enable = 0)	This parameter defines the polarity of the disabling object.
Behaviour at the beginning of the disabling function switching object 1.2	No reaction On Off Toggle	With an active disable, the second switching object is disabled. This parameter specifies the command transmitted via this object at the beginning of the disabling. "TOGGLE" switches over the current object value.
Behaviour at the end of disabling function switching object 1.2	No reaction On Off Transmit current input status	With an active disable, the second switching object is disabled. This parameter specifies the command transmitted via this object at the end of the disabling. In the "Transmit current input status" setting, the device evaluates the current static signal status of the input and, according to this, transmits the appropriately configured telegram to the KNX (contact closed at the input = telegram as with rising edge; contact open at input = telegram as with falling edge).
 □ Dimming		
Debounce time		This parameter specifies the software debouncing time. Depending on the quality of the connected contacts, you can define here after which actuation period the binary input detects a valid actuation.
Milliseconds	10 ... 30 ... 255	This parameter specifies the software debouncing time. Depending on the quality of the connected contacts, you

		can define here after which actuation period the binary input detects a valid actuation.
Operation		This parameter specifies the reaction to a rising edge at the input.
	Single area operation: darker/brighter (TOGGLE)	With a short signal length at the input, the object value of the switching object is toggled and an appropriate telegram transmitted. With a long signal length, a dimming telegram (brighter / darker). The dimming direction is only stored internally and switched on sequential dimming operations.
	Dual-area operation Brighter (On)	With a short signal length at the input, an ON telegram is triggered and, if there is a long signal length, a dimming telegram (brighter) is triggered.
	Dual-area operation Darker (OFF)	With a short signal length at the input, an OFF telegram is triggered and, if there is a long signal length, a dimming telegram (darker) is triggered.
	Dual-area operation Brighter (Toggle)	With a short signal length at the input, the object value of the switching object is toggled and an appropriate telegram transmitted, if there is a long signal length, a dimming telegram (brighter) is triggered.
	Dual-area operation Darker (Toggle)	With a short signal length at the input, the object value of the switching object is toggled and an appropriate telegram transmitted, if there is a long signal length, a dimming telegram (darker) is triggered.
Time between switching and dimming		Time from which the dimming function ("long signal length") is executed.
Seconds	0 ... 59	Sets the time seconds.
Milliseconds	4 ... 9	Sets the time milliseconds. The entered value, multiplied by 100, produces the time in milliseconds.
Response to bus voltage return		After a device reset (bus voltage return or ETS programming operation), the communication object "Switching" of the

		input can be initialised. If, in the ETS, a delay is set for the inputs after bus voltage return, the device only transmits the telegrams when the delay has elapsed.
Response to bus voltage return	No reaction	After a device reset, no reaction takes place automatically (no telegram is transmitted to the KNX).
Response to bus voltage return	Send ON telegram	In this configuration, an "ON" telegram is actively transmitted to the KNX after a device reset.
Response to bus voltage return	Send OFF telegram	In this configuration, an "OFF" telegram is actively transmitted to the KNX after a device reset.
Increase brightness by	100% 50% 25% 12.5% 6% 3% 1.5%	A dimming telegram can increase brightness by a maximum of X %. This parameter determines the maximum dimming step width for a dimming telegram. This parameter depends on the set operation.
reduce brightness by	100% 50% 25% 12.5% 6% 3% 1.5%	A dimming telegram can increase darkness by a maximum of X %. This parameter determines the maximum dimming step width for a dimming telegram. This parameter depends on the set operation.
Send stop telegram ?	No Yes	One or no telegram is transmitted on releasing a pushbutton at the input (falling edge).
Telegram repetition ?	No Yes	It is possible to use this parameter to determine whether the dimming telegram should be repeated cyclically for a long signal length (actuation of a pushbutton at the input).
Time between two telegrams		
Seconds	0 ... 1 ... 59	Time between two telegrams when telegram repetition is active. A new dimming telegram is transmitted after

		<p>this time has elapsed. Sets the time seconds.</p>
<p>Milliseconds</p>	<p>5 ... 9</p>	<p>Sets the time milliseconds. The entered value, multiplied by 100, produces the time in milliseconds.</p>
<p>☐ ↵ Disable (dimming)</p>		
<p>Disabling function</p>	<p>Disabled enabled</p>	<p>The inputs can be separately disabled via the bus using 1-bit objects. With an active disabling function, signal edges at the input are ignored by the device related to the affected objects. This parameter enables the disabling function of the input.</p>
<p>Polarity of the disabling object</p>	<p>Disable = 0 (Enable = 1) Disable = 1 (Enable = 0)</p>	<p>This parameter defines the polarity of the disabling object.</p>
<p>Behaviour at the beginning of the disabling function</p>	<p>No reaction On Off Toggle</p>	<p>With an active disable, the input is disabled. This parameter specifies the command transmitted via the "Switching" object at the beginning of the disabling. "TOGGLE" switches over the current object value.</p>
<p>Behaviour at the end of the disabling function</p>	<p>No reaction Off</p>	<p>With an active disable, the input is disabled. This parameter specifies the command transmitted via the "Switching" object at the end of the disabling.</p>
<p>☐ ↵ Venetian blind</p>		
<p>Debounce time</p>		<p>This parameter specifies the software debouncing time. Depending on the quality of the connected contacts, you can define here after which actuation period the binary input detects a valid actuation.</p>
<p>Milliseconds</p>	<p>10 ... 30 ... 255</p>	<p>This parameter specifies the software debouncing time in milliseconds.</p>
<p>Command on rising edge</p>	<p>No function</p>	<p>This parameter specifies the reaction to a rising edge at the input.</p>

		The input is deactivated.
	up	A short time telegram (UP) is triggered by a short signal length and a long time telegram (high) is triggered by a long signal length.
	Down	A short time telegram (DOWN) is triggered by a short signal length and a long time telegram (low) is triggered by a long signal length.
	Toggle	With this setting, the direction is switched over internally long signal length (MOVE). If a short time signal transmits a STEP telegram, then this STEP is always switched in the opposite direction of the last MOVE. Several STEP telegrams transmitted successively are switched in the same direction.
Response to bus voltage return		After a device reset (bus voltage return or ETS programming operation), the communication object "Long-time operation" of the input can be initialised. If, in the ETS, a delay is set for the binary inputs after bus voltage return, the device only transmits the telegrams when the delay has elapsed.
	No reaction	After a device reset, no reaction takes place automatically (no telegram is transmitted to the KNX).
	up	In this configuration, an "UP" telegram is actively transmitted to the KNX after a device reset.
	Down	In this configuration, a "DOWN" telegram is actively transmitted to the KNX after a device reset.
Operation concept		This parameter specifies the telegram sequence after actuation (rising edge).
	short - long - short	A STEP is transmitted with a rising edge and the "Time between short and long time operation" started. This STEP serves the purpose of stopping a continuous movement. If, within the started time, a falling edge is detected, the input does not transmit an additional telegram. If no falling edge was detected during the time, a MOVE is transmitted

		<p>automatically after the time has elapsed and the "slat adjustment time" is started. If a falling edge is detected within the slat adjustment time, the input transmits a STEP. This function is used for slat adjustment. The "slat adjusting time" should correspond to the time required for a 180° rotation of the slats.</p>
	long - short	<p>A MOVE is transmitted when there is a rising edge at the input and the "slat adjustment time" started. If a falling edge is detected within the started time, the input transmits a STEP. This function is used for slat adjustment. The "slat adjusting time" should correspond to the time required for a 180° rotation of the slats.</p>
Time between step and move operation		
Seconds	0 ... 59	Time after which the function of a long actuation is executed. Only visible with "Operation concept = "Short – Long – Short". Sets the time seconds.
Milliseconds	4 ... 9	Sets the time milliseconds. The entered value, multiplied by 100, produces the time in milliseconds.
Slat adjusting time		Time during which a long time telegram for slat adjustment can be terminated by a falling edge at the input.
Seconds	0 ... 2 ... 59	Sets the time seconds.
Milliseconds	0 ... 9	Sets the time milliseconds. The entered value, multiplied by 100, produces the time in milliseconds.
<input type="checkbox"/> Disable (Venetian blind)		
Disabling function	Disabled enabled	The inputs can be separately disabled via the bus using 1-bit objects. With an active disabling function, signal edges at the input are ignored by the device related to the affected objects. This parameter enables the disabling function of the input.
Polarity of the disabling object	Disable = 0 (Enable = 1) Disable = 1 (Enable = 0)	This parameter defines the polarity of the disabling object.

Behaviour at the beginning of the disabling function	No function up Down Toggle	With an active disable, the input is disabled. This parameter specifies the command transmitted via the "Long time operation" object at the beginning of the disabling. "TOGGLE" switches over the current object value.
Behaviour at the end of the disabling function	No function up Down Toggle	With an active disable, the input is disabled. This parameter specifies the command transmitted via the "Long time operation" object at the end of the disabling. "TOGGLE" switches over the current object value.
□ Dimming value transmitter		
Debounce time		This parameter specifies the software debouncing time. Depending on the quality of the connected contacts, you can define here after which actuation period the binary input detects a valid actuation.
Milliseconds	10 ... 30 ... 255	This parameter specifies the software debouncing time in milliseconds.
Transmit value on	rising edge (Button as NO contact) falling edge (Pushbutton as NC contact) rising and falling edge (Switch)	This parameter specifies the edge which starts signal evaluation in the device.
Value on rising edge	0 ... 100 ... 255	This parameter specifies the value transmitted on a rising edge. Only visible with "Transmit value on = rising edge (pushbutton as NO contact)" and "Transmit value on = rising and falling edge (switch)".
Value on falling edge	0 ... 255	This parameter specifies the value transmitted on a falling edge. Only visible with "Transmit value on = falling edge (pushbutton as NC contact)" and "Transmit value on = rising and falling edge (switch)".

Response to bus voltage return

After a device reset (bus voltage return or ETS programming operation), the communication object of the value transmitter can be initialised. If, in the ETS, a delay is set for the binary input after bus voltage return, the device only transmits the telegrams when the delay has elapsed.

No reaction

After a device reset, no reaction takes place automatically (no telegram is transmitted to the KNX).

Reaction as rising edge

In this configuration, a telegram is actively transmitted to the KNX after a device reset in accordance with the configuration for the rising edge. This setting can only be configured with "Transmit value on = rising edge (pushbutton as NO contact)".

Reaction as falling edge

In this configuration, a telegram is actively transmitted to the KNX after a device reset in accordance with the configuration for the falling edge. This setting can only be configured with "Transmit value on = falling edge (pushbutton as NC contact)".

Transmit current input status

In this setting, the device evaluates the static signal status of the input and, according to this, transmits the appropriately configured telegram to the KNX (contact closed at the input = telegram as with rising edge; contact open at input = telegram as with falling edge). This setting can only be configured with "Transmit value on = rising and falling edge (switch)".

Adjustment via long actuation

No

Yes

With the dimming value transmitter, the value to be transmitted can be calibrated at any time during device operation. A value adjustment can only be configured here when the value is to be transmitted only on a rising edge or only on a falling edge, i.e. a push-button is connected to the input. A value adjustment is introduced by a long signal at the input (> 5 s) and continues for as long as the signal is detected as active, i.e. the push-button is actuated. With the first adjustment after commissioning, the value programmed by the ETS is increased cyclically by the step width configured for the dimming value transmitter and transmitted. The

		<p>previously transmitted value is saved after releasing the pushbutton. The next long pushbutton actuation adjusts the saved value and the direction of the value adjustment changes. Only visible with "Transmit value on = rising edge (push-button as NO contact)" and "Transmit value on = falling edge (push-button as NC contact)".</p>
Time between two telegrams		<p>The time between two telegrams on adjusting values can be configured here. Only visible on "Adjustment via long actuation = Yes".</p>
Seconds	0 ... 1 ... 59	Sets the time seconds.
Milliseconds	5 ... 9	Sets the milliseconds (5...9 x 100).
Step width	0 ... 10 ... 15	Step width by which the adjusted value is increased or decreased with long actuation.
<p><input type="checkbox"/> Disable (Dimming value transmitter)</p>		
Disabling function	<p>Disabled</p> <p>enabled</p>	<p>The inputs can be separately disabled via the bus using 1-bit objects. With an active disabling function, signal edges at the input are ignored by the device related to the affected objects. This parameter enables the disabling function of the input.</p>
Polarity of the disabling object	<p>Disable = 0 (Enable = 1)</p> <p>Disable = 1 (Enable = 0)</p>	<p>This parameter defines the polarity of the disabling object.</p>
Behaviour at the beginning of the disabling function	<p>No reaction</p> <p>Reaction as rising edge</p> <p>Reaction as falling edge</p> <p>Transmit current input status</p>	<p>With an active disable, the input is disabled. This parameter specifies the command transmitted via the value object at the beginning of the disabling. In the "Transmit current input status" setting, the device evaluates the static signal status of the input and, according to this, transmits the appropriately configured telegram to the bus (contact closed at the input = telegram as with rising edge; contact open at input = telegram as with falling edge). The selection of the settings of this parameter depends on the configured</p>

edge evaluation of the input.

Behaviour at the end of the disabling function

No reaction

Reaction as rising edge

Reaction as falling edge

Transmit current input status

With an active disable, the input is disabled. This parameter specifies the command transmitted via the value object at the end of the disabling. In the "Transmit current input status" setting, the device evaluates the static signal status of the input and, according to this, transmits the appropriately configured telegram to the bus (contact closed at the input = telegram as with rising edge; contact open at input = telegram as with falling edge). The selection of the settings of this parameter depends on the configured edge evaluation of the input.

☐ Light scene extension without memory function

Debounce time

This parameter specifies the software debouncing time. Depending on the quality of the connected contacts, you can define here after which actuation period the binary input detects a valid actuation.

Milliseconds

10 ... **30** ... 255

This parameter specifies the software debouncing time in milliseconds.

Transmit light scene number on

**rising edge
(Button as NO contact)**

This parameter specifies the edge which starts signal evaluation in the device.

falling edge
(Pushbutton as NC contact)

rising and falling edge
(Switch)

Light scene on rising edge

1 ... 64

This parameter specifies the light scene number transmitted on a rising edge. Only visible with "Transmit value on = rising edge (pushbutton as NO contact)" and "Transmit value on = rising and falling edge (switch)".

Light scene on falling edge

1 ... 64

This parameter specifies the light scene number transmitted on a falling edge. Only visible with "Transmit value on = falling edge (pushbutton as NC contact)" and "Transmit value on = rising and falling edge (switch)".

Response to bus voltage return		After a device reset (bus voltage return or ETS programming operation), the communication object of the light scene extension can be initialised. If, in the ETS, a delay is set for the binary inputs after bus voltage return, the device only transmits the telegrams when the delay has elapsed.
	No reaction	After a device reset, no reaction takes place automatically (no telegram is transmitted to the KNX).
	Reaction as rising edge	In this configuration, a telegram is actively transmitted to the KNX after a device reset in accordance with the configuration for the rising edge. This setting can only be configured with "Transmit value on = rising edge (pushbutton as NO contact)".
	Reaction as falling edge	In this configuration, a telegram is actively transmitted to the KNX after a device reset in accordance with the configuration for the falling edge. This setting can only be configured with "Transmit value on = falling edge (pushbutton as NC contact)".
☐- Disable (Light scene extension without memory function)		
Disabling function	Disabled enabled	The inputs can be separately disabled via the bus using 1-bit objects. With an active disabling function, signal edges at the input are ignored by the device related to the affected objects. This parameter enables the disabling function of the input.
Polarity of the disabling object	Disable = 0 (Enable = 1) Disable = 1 (Enable = 0)	This parameter defines the polarity of the disabling object.
Behaviour at the beginning of the disabling function	No reaction Reaction as rising edge Reaction as falling edge Transmit current input status	With an active disable, the input is disabled. This parameter specifies the command transmitted via the value object at the beginning of the disabling. In the "Transmit current input status" setting, the device evaluates the static signal status of the input and, according to this, transmits the appropriately configured telegram to the bus (contact closed at the input = telegram as with rising edge; contact open at input = telegram as with falling edge). The selection of the settings of this

		parameter depends on the configured edge evaluation of the input.
Behaviour at the end of the disabling function	<p>No reaction</p> <p>Reaction as rising edge</p> <p>Reaction as falling edge</p> <p>Transmit current input status</p>	<p>With an active disable, the input is disabled. This parameter specifies the command transmitted via the value object at the end of the disabling. In the "Transmit current input status" setting, the device evaluates the static signal status of the input and, according to this, transmits the appropriately configured telegram to the bus (contact closed at the input = telegram as with rising edge; contact open at input = telegram as with falling edge). The selection of the settings of this parameter depends on the configured edge evaluation of the input.</p>
☐ Light scene extension with memory function		
Debounce time		This parameter specifies the software debouncing time. Depending on the quality of the connected contacts, you can define here after which actuation period the binary input detects a valid actuation.
Milliseconds	10 ... 30 ... 255	This parameter specifies the software debouncing time in milliseconds.
Transmit light scene number on	<p>rising edge (Button as NO contact)</p> <p>falling edge (Pushbutton as NC contact)</p>	This parameter specifies the edge which starts signal evaluation in the device.
only memory function ?	<p>No</p> <p>Yes</p>	If this parameter is set to "Yes", the input saves on a rising edge or a falling edge, depending on the project design. The input then transmits a memory telegram without prior light scene recall.
Time for long actuation for storage	5 ... 59	This parameter defines the actuation length of the pushbutton, so that the input transmits a storage telegram. Only visible, if the parameter "Only storage function" is set to "No".
Light scene on rising edge	1 ... 64	This parameter specifies the light scene number transmitted on a rising edge. Only visible with "Transmit value on =

		rising edge (pushbutton as NO contact)" and "Transmit value on = rising and falling edge (switch)".
Light scene on falling edge	1 ... 64	This parameter specifies the light scene number transmitted on a falling edge. Only visible with "Transmit value on = falling edge (pushbutton as NC contact)" and "Transmit value on = rising and falling edge (switch)".
Response to bus voltage return		After a device reset (bus voltage return or ETS programming operation), the communication object of the light scene extension can be initialised. If, in the ETS, a delay is set for the binary inputs after bus voltage return, the device only transmits the telegrams when the delay has elapsed.
	No reaction	After a device reset, no reaction takes place automatically (no telegram is transmitted to the KNX).
	Reaction as rising edge	In this configuration, a telegram is actively transmitted to the KNX after a device reset in accordance with the configuration for the rising edge. This setting can only be configured with "Transmit value on = rising edge (pushbutton as NO contact)".
	Reaction as falling edge	In this configuration, a telegram is actively transmitted to the KNX after a device reset in accordance with the configuration for the falling edge. This setting can only be configured with "Transmit value on = falling edge (pushbutton as NC contact)".
<input type="checkbox"/> Disable (Light scene extension with memory function)		
Disabling function	Disabled enabled	The inputs can be separately disabled via the bus using 1-bit objects. With an active disabling function, signal edges at the input are ignored by the device related to the affected objects. This parameter enables the disabling function of the input.
Polarity of the disabling object	Disable = 0 (Enable = 1) Disable = 1 (Enable = 0)	This parameter defines the polarity of the disabling object.

Behaviour at the beginning of the disabling function	<p>No function</p> <p>Reaction as rising edge</p> <p>Reaction as falling edge</p>	<p>With an active disable, the input is disabled. This parameter specifies the command transmitted via the value object at the beginning of the disabling. The selection of the settings of this parameter depends on the configured edge evaluation of the input.</p>
Behaviour at the end of the disabling function	<p>No function</p> <p>Reaction as rising edge</p> <p>Reaction as falling edge</p>	<p>With an active disable, the input is disabled. This parameter specifies the command transmitted via the value object at the end of the disabling. The selection of the settings of this parameter depends on the configured edge evaluation of the input.</p>
<p>☐ Temperature value transmitter</p>		
Debounce time		<p>This parameter specifies the software debouncing time. Depending on the quality of the connected contacts, you can define here after which actuation period the binary input detects a valid actuation.</p>
Milliseconds	10 ... 30 ... 255	<p>This parameter specifies the software debouncing time in milliseconds.</p>
Transmit value on	<p>rising edge (Button as NO contact)</p> <p>falling edge (Pushbutton as NC contact)</p> <p>rising and falling edge (switch)</p>	<p>This parameter specifies the edge which starts signal evaluation in the device.</p>
Value on rising edge	0°C ... 20°C ... 40°C	<p>This parameter specifies the temperature value transmitted on a rising edge. Only visible with "Transmit value on = rising edge (pushbutton as NO contact)" and "Transmit value on = rising and falling edge (switch)".</p>
Value on falling edge	0°C ... 18°C ... 40°C	<p>This parameter specifies the temperature value transmitted on a falling edge. Only visible with "Transmit value on = falling edge (pushbutton as NC contact)" and "Transmit value on = rising and falling edge (switch)".</p>

Response to bus voltage return	<p>After a device reset (bus voltage return or ETS programming operation), the communication object of the value transmitter can be initialised. If, in the ETS, a delay is set for the binary inputs after bus voltage return, the device only transmits the telegrams when the delay has elapsed.</p>	
No reaction	<p>After a device reset, no reaction takes place automatically (no telegram is transmitted to the KNX).</p>	
Reaction as rising edge	<p>In this configuration, a telegram is actively transmitted to the KNX after a device reset in accordance with the configuration for the rising edge. This setting can only be configured with "Transmit value on = rising edge (pushbutton as NO contact)".</p>	
Reaction as falling edge	<p>In this configuration, a telegram is actively transmitted to the KNX after a device reset in accordance with the configuration for the falling edge. This setting can only be configured with "Transmit value on = falling edge (pushbutton as NC contact)".</p>	
Transmit current input status	<p>In this setting, the device evaluates the static signal status of the input and, according to this, transmits the appropriately configured telegram to the KNX (contact closed at the input = telegram as with rising edge; contact open at input = telegram as with falling edge). This setting can only be configured with "Transmit value on = rising and falling edge (switch)".</p>	
Adjustment via long actuation	No	<p>With the temperature value transmitter, the value to be transmitted can be calibrated at any time during device operation. A value adjustment can only be configured here when the value is to be transmitted only on a rising edge or only on a falling edge, i.e. a push-button is connected to the input. A value adjustment is introduced by a long signal at the input (> 5 s) and continues for as long as the signal is detected as active, i.e. the push-button is actuated. With the first adjustment after commissioning, the value programmed by the ETS is increased cyclically by the</p>
	Yes	

		<p>step width (1 °C) permanently defined for the temperature value transmitter and transmitted. The previously transmitted value is saved after releasing the pushbutton. The next long pushbutton actuation adjusts the saved value and the direction of the value adjustment changes.</p> <p>Only visible with "Transmit value on = rising edge (push-button as NO contact)" and "Transmit value on = falling edge (push-button as NC contact)".</p>
Time between two telegrams		<p>The time between two telegrams on adjusting values can be configured here. Only visible on "Adjustment via long actuation = Yes".</p>
Seconds	0 ... 1 ... 59	Sets the time seconds.
Milliseconds	5 ... 9	Sets the milliseconds (5...9 x 100).
<p><input type="checkbox"/> Disable (Temperature value transmitter)</p>		
Disabling function	<p>Disabled</p> <p>enabled</p>	<p>The inputs can be separately disabled via the bus using 1-bit objects. With an active disabling function, signal edges at the input are ignored by the device related to the affected objects. This parameter enables the disabling function of the input.</p>
Polarity of the disabling object	<p>Disable = 0 (Enable = 1)</p> <p>Disable = 1 (Enable = 0)</p>	<p>This parameter defines the polarity of the disabling object.</p>
Behaviour at the beginning of the disabling function	<p>No reaction</p> <p>Reaction as rising edge</p> <p>Reaction as falling edge</p> <p>Transmit current input status</p>	<p>With an active disable, the input is disabled. This parameter specifies the command transmitted via the value object at the beginning of the disabling. In the "Transmit current input status" setting, the device evaluates the static signal status of the input and, according to this, transmits the appropriately configured telegram to the bus (contact closed at the input = telegram as with rising edge; contact open at input = telegram as with falling edge). The selection of the settings of this parameter depends on the configured edge evaluation of the input.</p>

Behaviour at the end of the disabling function	<p>No reaction</p> <p>Reaction as rising edge</p> <p>Reaction as falling edge</p> <p>Transmit current input status</p>	<p>With an active disable, the input is disabled. This parameter specifies the command transmitted via the value object at the end of the disabling. In the "Transmit current input status" setting, the device evaluates the static signal status of the input and, according to this, transmits the appropriately configured telegram to the bus (contact closed at the input = telegram as with rising edge; contact open at input = telegram as with falling edge). The selection of the settings of this parameter depends on the configured edge evaluation of the input.</p>
□- Brightness value transmitter		
Debounce time		<p>This parameter specifies the software debouncing time. Depending on the quality of the connected contacts, you can define here after which actuation period the binary input detects a valid actuation.</p>
Milliseconds	10 ... 30 ... 255	<p>This parameter specifies the software debouncing time in milliseconds.</p>
Transmit value on	<p>rising edge (Button as NO contact)</p> <p>falling edge (Pushbutton as NC contact)</p> <p>rising and falling edge (switch)</p>	<p>This parameter specifies the edge which starts signal evaluation in the device.</p>
Value on rising edge	0 Lux, 50 Lux, 100 Lux, 150 Lux, 200 Lux , ..., 1500 Lux	<p>This parameter specifies the brightness value (in 50 Lux steps) transmitted on a rising edge. Only visible with "Transmit value on = rising edge (pushbutton as NO contact)" and "Transmit value on = rising and falling edge (switch)".</p>
Value on falling edge	0 Lux , 50 Lux, 100 Lux, 150 Lux, ..., 1500 Lux	<p>This parameter specifies the brightness value (in 50 Lux steps) transmitted on a falling edge. Only visible with "Transmit value on = falling edge (pushbutton as NC contact)" and "Transmit value on = rising and falling edge (switch)".</p>

Response to bus voltage return		After a device reset (bus voltage return or ETS programming operation), the communication object of the value transmitter can be initialised. If, in the ETS, a delay is set for the binary inputs after bus voltage return, the device only transmits the telegrams when the delay has elapsed.
	No reaction	After a device reset, no reaction takes place automatically (no telegram is transmitted to the KNX).
	Reaction as rising edge	In this configuration, a telegram is actively transmitted to the KNX after a device reset in accordance with the configuration for the rising edge. This setting can only be configured with "Transmit value on = rising edge (pushbutton as NO contact)".
	Reaction as falling edge	In this configuration, a telegram is actively transmitted to the KNX after a device reset in accordance with the configuration for the falling edge. This setting can only be configured with "Transmit value on = falling edge (pushbutton as NC contact)".
	Transmit current input status	In this setting, the device evaluates the static signal status of the input and, according to this, transmits the appropriately configured telegram to the KNX (contact closed at the input = telegram as with rising edge; contact open at input = telegram as with falling edge). This setting can only be configured with "Transmit value on = rising and falling edge (switch)".
Adjustment via long actuation	No	With the brightness value transmitter, the value to be transmitted can be calibrated at any time during device operation. A value adjustment can only be configured here when the value is to be transmitted only on a rising edge or only on a falling edge, i.e. a push-button is connected to the input. A value adjustment is introduced by a long signal at the input (> 5 s) and continues for as long as the signal is detected as active, i.e. the push-button is actuated. With the first adjustment after commissioning, the value programmed by the ETS is increased cyclically by the
	Yes	

		step width (50 Lux) permanently defined for the brightness value transmitter and transmitted. The previously transmitted value is saved after releasing the pushbutton. The next long pushbutton actuation adjusts the saved value and the direction of the value adjustment changes. Only visible with "Transmit value on = rising edge (push-button as NO contact)" and "Transmit value on = falling edge (push-button as NC contact)".
Time between two telegrams		The time between two telegrams on adjusting values can be configured here. Only visible on "Adjustment via long actuation = Yes".
Seconds	0 ... 1 ... 59	Sets the time seconds.
Milliseconds (5...9)	5 ... 9	Sets the milliseconds (5...9 x 100).
☐ ↓ Disable (Brightness value transmitter)		
Disabling function	Disabled enabled	The inputs can be separately disabled via the bus using 1-bit objects. With an active disabling function, signal edges at the input are ignored by the device related to the affected objects. This parameter enables the disabling function of the input.
Polarity of the disabling object	Disable = 0 (Enable = 1) Disable = 1 (Enable = 0)	This parameter defines the polarity of the disabling object.
Behaviour at the beginning of the disabling function	No reaction Reaction as rising edge Reaction as falling edge Transmit current input status	With an active disable, the input is disabled. This parameter specifies the command transmitted via the value object at the beginning of the disabling. In the "Transmit current input status" setting, the device evaluates the static signal status of the input and, according to this, transmits the appropriately configured telegram to the bus (contact closed at the input = telegram as with rising edge; contact open at input = telegram as with falling edge). The selection of the settings of this parameter depends on the configured edge evaluation of the input.

Behaviour at the end of the disabling function	<p>No reaction</p> <p>Reaction as rising edge</p> <p>Reaction as falling edge</p> <p>Transmit current input status</p>	<p>With an active disable, the input is disabled. This parameter specifies the command transmitted via the value object at the end of the disabling. In the "Transmit current input status" setting, the device evaluates the static signal status of the input and, according to this, transmits the appropriately configured telegram to the bus (contact closed at the input = telegram as with rising edge; contact open at input = telegram as with falling edge). The selection of the settings of this parameter depends on the configured edge evaluation of the input.</p>
☐ Remote sensor		
Remote sensor calibration (K)	-128 ... 0 ... 127	<p>Determines the value by which the remote sensor's room temperature value is calibrated. The entered numeric value, multiplied by 0.1, produces the calibration value in Kelvin.</p> <p>This parameter is only visible when the temperature detection system requires a remote sensor.</p>
Transmission when room temperature change by (+/- K, 0 = inactive)	0 ... 255	<p>Only as of application program version "1.2". The parameter determines the size of the value change of the remote sensor's room temperature value, after which the temperature is automatically transmitted to the KNX via the objects "Measured value" and "Non-calibrated measured value". The entered numeric value, multiplied by 0.1, equals the temperature value by which the room temperature value must change so that it is transmitted.</p>
Response to bus voltage return	<p>no reaction</p> <p>Transmit current value</p>	<p>After a device reset (bus voltage return or ETS programming operation), the communication object of the remote sensor can be initialised. If, in the ETS, a delay is set for the binary input after bus voltage return, the device only transmits the telegrams when the delay has elapsed.</p> <p>After a device reset, no reaction takes place automatically (no telegram is transmitted to the KNX).</p> <p>In this setting, the device evaluates the current value at the input and, according to it, transmits the appropriate value</p>

		telegram to the KNX.
Cyclical transmission measured value	no cyclical transmission cyclical transmission	The calibrated value of the measured temperature of the remote sensor can be transmitted cyclically to the KNX. This parameter defines whether a telegram is transmitted cyclically to the KNX. Additional parameters for defining the cycle time become visible.
Hours	0 ... 23	The cycle time for transmitting the measured value can be configured here. Only visible with "Cyclical transmission of the measured value = Cyclical transmission"! Sets the time in hours.
minutes	0 ... 1 ... 59	The cycle time for transmitting the measured value can be configured here. Only visible with "Cyclical transmission of the measured value = Cyclical transmission"! Sets the time in minutes.
Seconds	1 ... 59	The cycle time for transmitting the measured value can be configured here. Only visible with "Cyclical transmission of the measured value = Cyclical transmission"! Sets the time seconds.
Cyclical transmission, non-balanced measured value	no cyclical transmission cyclical transmission	The uncalibrated value of the measured temperature of the remote sensor can be transmitted cyclically to the KNX. This parameter defines whether a telegram is transmitted cyclically to the KNX. Additional parameters for defining the cycle time become visible.
Hours	0 ... 23	The cycle time for transmitting the uncalibrated measured value can be configured here. Only visible with "Cyclical transmission of the uncalibrated measured value = Cyclical transmission"! Sets the time in hours.
minutes		The cycle time for transmitting the uncalibrated measured value can be

	0 ... 1 ... 59	configured here. Only visible with "Cyclical transmission of the uncalibrated measured value = Cyclical transmission"! Sets the time in minutes.
Seconds	1 ... 59	The cycle time for transmitting the uncalibrated measured value can be configured here. Only visible with "Cyclical transmission of the uncalibrated measured value = Cyclical transmission"! Sets the time seconds.

Temperature limiter underfloor heating

Only effective if the parameter "Underfloor heating temperature limiting" on the parameter page "Controller functionality" is set to "Available".

If the input executes the function "Temperature limiter, underfloor heating", then the device measures the temperature via the temperature sensor connected at the input. The measured temperature value can be calibrated on the parameter page "Room temperature measurement" (parameter "Calibration of temperature limiter"). The device executes the function "Underfloor heating temperature limiting" with the calibrated temperature value. The temperature value can be transmitted to the KNX via the "Floor temperature" output object.

If the input does not work as "Temperature limiter, underfloor heating", then a valid temperature must be specified for the device via the input object "Floor temperature". The device executes the function "Underfloor heating temperature limiting" with the received temperature value.

The function "Underfloor heating temperature limiting" is configured on the parameter page "Controller functionality".

4.2.5.4 Room temperature measurement

Description	Values	Comment
□- Parameter group "Room temperature measurement"		
Room temperature measurement	switched-off Switched-on	This parameter enables the room temperature measurement of the device. Additional parameters become visible.
Calibration of temperature limiter (K)	-128 ... 0 ... 127	Determines the value in Kelvin by which the measured value of the sensor for the temperature limiting of the underfloor heating is calibrated. This parameter is only visible if the parameter "Function input" is set to "Temperature limiter, underfloor heating".
Temperature detection through		The parameter specifies which sensor is used for room temperature measurement. Various selection options are available according to the set function of the input.
	internal temperature sensor	Setting Internal sensor: The actual temperature is determined solely via the temperature sensor integrated in the device. Its measured temperature value can be transmitted to the KNX or read out, in uncalibrated or calibrated form, via 2-byte communication objects. In this configuration, the feedback control will start directly after a device reset.
	Remote sensor	Setting "Remote sensor": Only available when the function of the input is set to "Remote sensor". The actual temperature is determined solely via the remote sensor connected to the input. Its measured temperature value can be transmitted to the KNX or read out, in uncalibrated or calibrated form, via 2-byte communication objects. The measured temperature value is automatically sent when a change is made to a configurable temperature value (parameter "Transmit on temperature change by"). In this configuration, the feedback control will start directly after a device reset. The precondition for this is that a remote sensor is connected!
		"Received temperature value" setting; Actual temperature is determined solely

received temperature value	via a temperature value received from the KNX. In this case, the sensor must either be a KNX room thermostat coupled via the 2-byte object "Received temperature" or a controller extension with temperature detection. After a device reset the room temperature controller will first wait for a valid temperature telegram until the feedback control starts and a command value, if applicable, is output.
Internal sensor and remote sensor	Setting "Internal sensor and remote sensor": Only available when the function of the input is set to "Remote sensor". These settings are used to combine the selected temperature sources. The sensors are the internal sensor and a remote sensor directly connected to the controller. When using the remote sensor, its isolated measured temperature value can be transmitted to the KNX or read out, in uncalibrated or calibrated form, via 2-byte communication objects.
internal sensor and received temperature value	Setting "internal sensor and received temperature value": In these settings, the selected temperature sources are combined together. The sensors are the internal sensor and a KNX room thermostat coupled via the 2-byte object "Received temperature" or a controller extension with temperature detection. After a device reset the room temperature controller will first wait for a valid temperature telegram until the feedback control starts and a command value, if applicable, is output.
Internal sensor and received temperature value	Setting "Remote sensor and received temperature value": Only available when the function of the input is set to "Remote sensor". These settings are used to combine the selected temperature sources. The sensors are a remote sensor directly connected to the controller and a KNX room thermostat coupled via the 2-byte object "Received temperature", or controller extensions with temperature detection. When using the remote sensor, its isolated measured temperature value can be transmitted to the KNX or read out, in uncalibrated or calibrated form, via 2-byte communication objects. After a device

		reset the room temperature controller will first wait for a valid temperature telegram until the feedback control starts and a command value, if applicable, is output.
Internal sensor calibration (K)	-128 ... 0 ... 127	Determines the value by which the internal sensor's room temperature value is calibrated. The entered numeric value, multiplied by 0.1, produces the calibration value in Kelvin. This parameter is only visible when the temperature detection system requires an internal sensor.
Calibration of received temperat. value (K)	-128 ... 0 ... 127	Determines the value by which the temperature value received from the KNX is calibrated. The entered numeric value, multiplied by 0.1, produces the calibration value in Kelvin. This parameter is only visible when the temperature detection system requires that a temperature value is received.
Request time for received value (minutes, 0 = inactive)	0 ... 255	The polling time for the temperature value received from the KNX is specified here. In the "0" setting, the temperature value is not automatically polled by the controller. In this case the communication partner (e.g. controller extension) must transmit its temperature value itself. This parameter is only visible when the temperature detection system requires that a temperature value is received.
Measured value formation, internal sensor to remote sensor	10% to 90% 20% to 80% 30% to 70% 40% to 60% 50% to 50% 60% to 40% 70% to 30% 80% to 20% 90% to 10%	The weighting of the measured temperature value for the internal and the remote sensor is specified here. That results in an overall value, which will be used for the further interpretation of the room temperature. This parameter is only visible with "Temperature detection by = Internal sensor and remote sensor".
Measured value formation of internal sensor, temperature value to be received	10% to 90% 20% to 80% 30% to 70% 40% to 60% 50% to 50% 60% to 40% 70% to 30% 80% to 20%	The weighting of the measured temperature value for the internal sensor and the temperature value received from the KNX is specified here. That results in an overall value, which will be used for the further interpretation of the room temperature. This parameter is only visible with

	90% to 10%	"Temperature detection by = Internal sensor and received temperature value!"
Measured value formation of remote sensor, temperature value to be received	10% to 90% 20% to 80% 30% to 70% 40% to 60% 50% to 50% 60% to 40% 70% to 30% 80% to 20% 90% to 10%	The weighting of the measured temperature value for the remote sensor and the temperature value received from the KNX is specified here. That results in an overall value, which will be used for the further interpretation of the room temperature. This parameter is only visible with "Temperature detection by = Remote sensor and received temperature value!"
Cyclical transmission of the actual temperature (minutes, 0 = inactive)	0 ... 15 ... 255	This parameter specifies whether and when the determined room temperature of the control circuit is to be periodically output via the "Actual temperature" object.
Transmit at actual temperature change of (+/- K, 0 = inactive)	0 ... 3 ... 255	Determines the size of the value change of the room temperature of the control circuit after which the current values are automatically transmitted to the KNX via the "Actual temperature" object. The entered numeric value, multiplied by 0.1, equals the temperature value by which the room temperature must change for the room temperature to be transmitted.

4.2.5.5 Room temperature controller

Description	Values	Comment
<input type="checkbox"/> Room temperature controller		
Room temperature controller function		<p>The controller function block, integrated in the device, works as a main controller. The setting of this parameter enables the room temperature controller and has a major impact on the function and on the other parameters and objects displayed in the ETS.</p> <p>If room temperature measurement is switched off, no room temperature control is possible. For this reason, this parameter is then permanently "switched off".</p>
	switched-off	<p>The controller function block is switched off completely. No room temperature control can be executed by the device.</p>
	Switched-on	<p>The controller function block works as a main controller. The internal control algorithm is active, meaning that the device can be used for single-room temperature control.</p>
<input type="checkbox"/> Controller general		
Operating mode	<p>Heating</p> <p>Cooling</p> <p>Heating and cooling</p> <p>Basic and additional heating</p> <p>Basic and additional cooling</p> <p>Basic and additional heating and cooling</p>	<p>The room temperature controller distinguishes between two different operating modes. The operating modes specify whether you want the controller to use its variable to trigger heating systems ("heating" single operating mode) or cooling systems ("cooling" single operating mode). You can also activate mixed operation, with the controller being capable of changing over between "Heating" and "Cooling" either automatically or, alternatively, controlled by a communication object. In addition, you can establish two-level control operation to control an additional heating or cooling unit. For two-level feedback control, separate command values will be calculated as a function of the temperature deviation between the setpoint and the actual value and transmitted to the bus for the basic and additional levels.</p> <p>This parameter specifies the operating mode and, if necessary, enables the additional level(s). If you use two control circuits you can only choose between the "heating" or "cooling" mode.</p>

i The settings of the parameters "Operating mode" and "Valve drive control via" (parameter page "Valve drive") must be adjusted to each other.

Fan controller available **No**
Yes

The room temperature control can be supplemented with a fan controller using this parameter. By enabling the fan controller ("Yes" setting), it is possible to control the fan from heating and cooling systems operated by circulating air, such as fan coil units (FanCoil units), depending on the command value calculated in the controller or using manual operation.
When the function is enabled additional parameters will appear in the ETS in the "Room temperature control -> Controller general -> Fan controller" as well as additional communication objects. Fan control is not possible with switching 2-point feedback control.

Fan operating mode Heating
Cooling
Heating and cooling
Basic heating
Additional heating
Basic cooling
Additional cooling
Basic heating and cooling
Basic heating and additional cooling
Basic cooling and additional heating
Additional heating and cooling

Depending on the operating mode of the room temperature control, as configured in the ETS, various controller command values can be used as the basis for fan control. The "Fan operating mode" parameter specifies which command value of the controller controls the fan controller. With one-level room temperature control, it is possible to select whether the fan is activated during heating and/or during cooling. With two-level room temperature control, it is also possible for the fan controller to be set to the basic level or the additional level during heating and cooling. However, under no circumstances is it possible to use the basic and additional levels simultaneously for a fan controller within an operating mode.
This basic setting of this parameter depends on the selected controller operating mode.

Transmit heating and cooling command values to one common object **No**
Yes

If the parameter is set to "Yes", the command value will be transmitted on a shared object during heating or cooling. This function is used, if the same heating system is used to cool the room in the summer and used to heat the room in the winter.
This parameter is only visible with "heating and cooling" mixed operating

		mode, if applicable, with additional levels.
Type of heating control (if applicable, for basic and additional stage)	Continuous PI control Switching PI control (PWM) Switching 2-point feedback control (ON/OFF)	Selecting a feedback control algorithm (PI or 2-point) with data format (1-byte or 1-bit) for the heating system. ⓘ The settings of this parameter must be adjusted with the setting of the parameter "Valve drive control via" (parameter page "Valve drive") if the valve drive is to be actuated with the internal command values heating / basic heating or additional heating.
Type of heating (if applicable, for basic and additional level)	Hot water heater (5 K / 150 min) Underfloor heating (5 K / 240 min) Electric heating (4 K / 100 min) Fan coil unit (4 K / 90 min) Split unit (4 K / 90 min) via control parameter	Adapting the PI algorithm to different heating systems using predefined values for the proportional range and reset time control parameters. With the "Using control parameters" setting, it is possible to set the control parameters in a manner deviating from the predefined values within specific limits. This parameter is only visible if "Type of heating control = PI control".
Proportional range heating (10 ... 127) * 0.1 K	10... 50 ...127	Separate setting of the "Proportional range" control parameter. This parameter is only visible if "Type of heating = via control parameter" and the heating control type "PI control".
Reset time heating (0 ... 255) * 1 min; 0 = inactive	0... 150 ...255	Separate setting of the "Reset time" control parameter. This parameter is only visible if "Type of heating = via control parameter" and the heating control type "PI control".
Bottom hysteresis of the 2-point controller heating (-128 ... -5) * 0.1 K	-128... -5	Definition of bottom hysteresis (switch-on temperatures) of the heating. This parameter is only visible if "Type of heating control = Switching 2-point feedback control".
Top hysteresis of the 2-point controller	5 ...127	Definition of top hysteresis (switch-off temperatures) of the heating.

heating (5 ... 127) * 0.1 K		This parameter is only visible if "Type of heating control = Switching 2-point feedback control".
Type of cooling control (if applicable, for basic and additional level and for a second control circuit)	Continuous PI control Switching PI control (PWM) Switching 2-point feedback control (ON/OFF)	Selecting a feedback control algorithm (PI or 2-point) with data format (1 byte or 1 bit) for the cooling system ⓘ The settings of this parameter must be adjusted with the setting of the parameter "Valve drive control via" (parameter page "Valve drive") if the valve drive is to be actuated with the internal command values cooling / basic cooling or additional cooling.
Type of cooling (if applicable, for basic and additional level and for a second control circuit)	Cooling ceiling (5 K / 240 min) Fan coil unit (4 K / 90 min) Split unit (4 K / 90 min) via control parameter	Adapting the PI algorithm to different cooling systems using predefined values for the proportional range and reset time control parameters. With the "Using control parameters" setting, it is possible to set the control parameters in a manner deviating from the predefined values within specific limits. This parameter is only visible if "Type of cooling control = PI control".
Proportional range cooling (10 ... 127) * 0.1 K	10... 50 ...127	Separate setting of the "Proportional range" control parameter. This parameter is only visible if "Type of cooling = via control parameter" and the cooling control type "PI control".
Reset time cooling (0 ... 255) * 1 min; 0 = inactive	0... 240 ...255	Separate setting of the "Reset time" control parameter. This parameter is only visible if "Type of cooling = via control parameter" and the cooling control type "PI control".
Cooling 2-point controller hysteresis lower limit (-128 ... -5) * 0.1 K	-128... -5	Definition of bottom hysteresis (switch-off temperatures) of the cooling. This parameter is only visible if "Type of cooling control = Switching 2-point control".
Top hysteresis of the 2-point controller cooling (5 ... 127) * 0.1 K	5 ...127	Definition of top hysteresis (switch-on temperatures) of the cooling. This parameter is only visible if "Type of cooling control = Switching 2-point control".

Additional stage inhibit object	No Yes	The additional levels can be separately disabled via the KNX. The parameter enables the disable object as necessary. This parameter is only visible in two-level heating and cooling operation.
Operating mode switch-over	via value (1 byte) via switching (4 x 1 bit)	In the setting "Via value (1-byte) the change-over of the operating modes via the KNX takes place according to the KNX specification via a 1-byte value object. In addition, a higher-ranking forced object is available for this setting. In the setting "Via switching (4 x 1 bit)" the change-over of the operating modes via the KNX is via four separate 1-bit objects.
Operation mode after reset	Restore operating mode before reset Comfort mode Standby mode Night operation Frost/heat protection mode	This parameter specifies which operating mode is set immediately after a device reset. With "Restore operation mode before reset": The operating mode set before a reset will be restored after the initialisation phase of the device. Operating modes set by a function with a higher priority before the reset (Forced, Window status, Presence status) are not effected. Frequent changing of the operating mode (e. g. several times a day) during running operation can adversely affect the life of the device as the read-only memory (EEPROM) used has been designed for less frequent write access events only.
Frost/heat protection	Automatic frost protection via window status	Here it is possible to determine how the room temperature regulator switches into the frost/heat protection. With "automatic frost protection": the automatic frost protection is activated. Depending on the room temperature this allows an automatic switch-over into the frost protection mode. With "Via window status": switch-over into the frost/heat protection takes place via the "window status" object.
Window status delay (0...255) * 1 min; 0 = inactive	0...255	This parameter defines the delay time for the window status. After the parameterised time has elapsed after the window is opened the window status will be changed and thus the frost/heat protection mode activated. This delay

Automatic frost protection temperature drop	Off 0.2 K / min. 0.3 K / min. 0.4 K / min. 0.5 K / min. 0.6 K / min.	<p>can make sense if short ventilation of the room by opening the window is not supposed to change the operating mode. Only visible if "Frost/heat protection = via window status"!</p>
Frost protection period in automatic mode (1...255) * 1 min.	1... 20 ...255	<p>This parameter determines the decrease temperature by which the room temperature has to decrease within one minute in order for the controller to switch into the frost protection mode. The "OFF" setting will deactivate the frost protection automatic. Only visible if "frost/heat protection = Automatic frost protection"!</p>
<input type="checkbox"/> Fan controller		
Number of fan levels	No fan levels 1 fan level 2 fan levels 3 fan levels 4 fan levels 5 fan levels 6 fan levels 7 fan levels 8 fan levels	<p>The fan controller of the room temperature controller supports up to 8 fan level outputs, for which the actually used number of levels (1...8) is set using this parameter.</p>
Fan level change-over via	via switching objects (3 x 1 bit) via value object (1-byte)	<p>Depending on the data format of the objects of the controlled actuators, the change-over between the fan levels can either take place via up to 8 separate 1-bit objects or, alternatively, via one 1-byte object. The "Fan level change-over via" parameter defines the data format of the controller. With the 1-bit objects, each fan level discreetly receives its own object. With the 1-byte object, the active fan level is expressed by a value ("0" = Fan OFF / "1" = Level 1 / "2" = Level 2 / "3" = Level 3 / etc.).</p>
	0... 1 ...100	

<p>Fan OFF threshold value -> Level 1, * 1 %</p>		<p>In automatic operation, the command value of the controller is used internally in the device for automatic control of the fan levels. As a transition between the levels, there are threshold values, defined according to the command value of the controller, which can be set here. If the command value exceeds the threshold value of a level, the appropriate level is activated. If the command value sinks below a threshold value, minus the configured hysteresis, then the change-over takes place into the next lowest fan level.</p>
<p>Fan level 1 threshold value -> Level 2, * 1 %</p>	<p>0...30...100</p>	
<p>Fan level 2 threshold value -> Level 3, * 1 %</p>	<p>0...60...100</p>	
<p>Fan level 3 threshold value -> Level 4, * 1 %</p>	<p>0...90...100</p>	
<p>Fan level 4 threshold value -> Level 5, * 1 %</p>	<p>0...100</p>	
<p>Fan level 5 threshold value -> Level 6, * 1 %</p>	<p>0...100</p>	
<p>Fan level 6 threshold value -> Level 7, * 1 %</p>	<p>0...100</p>	
<p>Fan level 7 threshold value -> Level 8, * 1 %</p>	<p>0...100</p>	
<p>Hysteresis between threshold values, *1%</p>	<p>1...3...50</p>	<p>If the command value of the room temperature control has undershot the threshold value minus the hysteresis, the fan controller switches back to the previous level.</p>
<p>Waiting time for level change-over *0.1 s</p>	<p>1...2...255</p>	<p>Due to fan motors' inertia, as a rule there is a limit to how short the time intervals for switching the fan levels can be, i.e. there is a limit to how quickly the fan speed can be varied. If the fan controller is working in automatic mode, the settable "Waiting time on level change-over" is maintained on change-over of the levels.</p>
<p>Level limit (max. fan level)</p>	<p>No level limit Fan level 1</p>	<p>To reduce the fan noise of a fan coil, the fan level limit can be activated. The level</p>

	<p>Fan level 2 Fan level 3 Fan level 4 Fan level 5 Fan level 6 Fan level 7 Fan level 8</p>	<p>limit reduces the sound emissions by limiting the maximum fan level to a fan level value configured here (limitation level). The limit can be switched on and off using the "Fan, level limit" 1-bit object and thus activated as necessary.</p> <p>The parameter "Level limit" is not checked for plausibility, meaning that an incorrect configuration is possible. For this reason, care should be taken to ensure that there is no limit level in the configuration which is higher than the actual fan levels. If a higher limit level is configured, then the limit has no effect.</p>
Behaviour on forced position	<p>no forced position Fan level 1 Fan level 2 Fan level 3 Fan level 4 Fan level 5 Fan level 6 Fan level 7 Fan level 8 Fan level OFF</p>	<p>The controller provides the option of activating a forced fan position via the bus. With an active forced position, the fan levels can neither be controlled nor switched over in either automatic or manual mode. The fan remains in the forced state until the forced position is removed using the bus. In this manner, it is possible to switch the fan to a locked and controlled state, for example for servicing purposes.</p> <p>As soon as the forced position is activated, the controller jumps to the fan level configured in this parameter without any waiting time. The fan can also be completely switched off.</p>
Object interpretation, automatic/manual fan control	<p>0=Automatic mode, 1=Manual mode</p> <p>1=Automatic mode, 0=Manual mode</p>	<p>The parameter specifies the polarity of the object for the change-over between automatic and manual fan control. Automatic mode is always active after a device reset.</p>
Fan level on change-over to manual	<p>no change Fan level 1 Fan level 2 Fan level 3 Fan level 4 Fan level 5 Fan level 6 Fan level 7 Fan level 8 Fan level OFF</p>	<p>On change-over from automatic operation to manual operation, this parameter then decides whether the fan level most recently set in automatic operation is maintained, the fan is switched off or a defined fan level is set. The parameter "Fan level on change-over to manual" is not checked for plausibility in the ETS, meaning that an incorrect configuration is possible. For this reason, care should be taken to ensure that there is no level in the configuration which is higher than the actual fan levels. If a level which does not exist is to be configured for the change-over to manual control, then the</p>

		fan controller changes over to the maximum possible level when changing over to manual operation.
Heating fan run-on time, *0.1 s, 0=Inactive	0...255	If the fan is switched-off in automatic or manual operation, it runs on for the time configured at this point, provided that a factor of more than "0" is set. This parameter applies to the controller operating mode "Heating" (if necessary, in the basic and additional levels).
Cooling fan run-on time, *0.1 s, 0=Inactive	0...255	If the fan is switched-off in automatic or manual operation, it runs on for the time configured at this point, provided that a factor of more than "0" is set. This parameter applies to the controller operating mode "Cooling" (if necessary, in the basic and additional levels).
Fan protection	Yes No	The fan protection function allows the fan of a fan coil unit, which has not been active for some time, to be temporarily switched to the maximum level. In this way, the controller fan motors can be protected against stiffness. In addition, the fan blades and the heat exchanger of the fan coil unit are protected against dust against dust. If the fan protection is to be used, it must be enabled using the "Yes" setting at this point.
Start-up using level	Fan level OFF Fan level 1 Fan level 2 Fan level 3 Fan level 4 Fan level 5 Fan level 6 Fan level 7 Fan level 8	The fan can, if it was switched off before and should now start up, be switched on at a defined switch-on level. This switch-on level can be any of the available fan levels, and is set using this parameter. The switch-on level is usually one of the higher fan levels of a blower convector. The switch-on level remains active for the "Waiting time on level change-over" configured in the ETS. The parameter "Start-up via level" is not checked for plausibility in the ETS, meaning that an incorrect configuration is possible. For this reason, care should be taken to ensure that there is no switch-on level in the configuration which is higher than the actual fan levels. The fan controller automatically corrects a faulty parameterisation by activating level 1 for the start-up, meaning that the fan starts up normally

without a switch-on level.

Command value is 0%, until internal command value is greater than, *1% **1...100**

The command value evaluated by the fan controller in automatic operation can be optionally limited by this parameter in the bottom command value range.

Command value is 100%, as soon as internal command value is greater than, *1% **1...99...100**

The command value evaluated by the fan controller in Automatic mode can be optionally limited by this parameter in the top command value range.

Command value offset, *1% **0... 100**

The command value evaluated by the fan controller in Automatic mode can be optionally raised by the static offset configured here. Should the calculation produce a value of over 100 %, then the command value is limited to the maximum value.

□-| Command value and status output

Automatic transmission at modification by (0...100) * 1 %; 0 = inactive **0...3...100**

This parameter determines the size of the command value change that will automatically transmit continuous command value telegrams via the command value objects. Thus this parameter only affects command values which are configured to "Continuous PI control" and to the 1 byte additional command value objects of the "Switching PI control (PWM)".

Cycle time of the switching command value (1...255) * 1 min **1...15...255**

This parameter specifies the cycle time for the pulse width modulated command value (PWM). Thus this parameter only affects command values which are configured to "Switching PI control (PWM)".

Cycle time for automatic transmission (0...255) * 1 min; 0 = inactive **0...10...255**

This parameter determines the time interval for the cyclical transmission of the command values via all command value objects.

Output of the heating variable

Inverted (under current, this means closed)

At this point, it is possible to specify whether the command value telegram for heating is output normally or in inverted form.

Normal (under current, this means opened)

This parameter is only visible if the operating mode "Heating" or "Heating and cooling" is configured and not two-

level operation.

Output of the command value basic level heating	<p>Inverted (under current, this means closed)</p> <p>Normal (under current, this means opened)</p>	<p>At this point, it is possible to specify whether the command value telegram for the heating basic level is output normally or in inverted form. This parameter is only visible if the operating mode "Heating" or "Heating and cooling" is configured along with two-level operation.</p>
Output of the heating additional stage variable	<p>Inverted (under current, this means closed)</p> <p>Normal (under current, this means opened)</p>	<p>At this point, it is possible to specify whether the command value telegram for the heating additional level is output normally or in inverted form. This parameter is only visible if the operating mode "Heating" or "Heating and cooling" is configured along with two-level operation.</p>
Output of the heating command value control circuit 1	<p>Inverted (under current, this means closed)</p> <p>Normal (under current, this means opened)</p>	<p>At this point, it is possible to specify whether the command value telegram for heating of the first control circuit is output normally or in inverted form. This parameter is only visible if the operating mode "Heating" and two control circuits are configured.</p>
Output of the heating command value control circuit 2	<p>Inverted (under current, this means closed)</p> <p>Normal (under current, this means opened)</p>	<p>At this point, it is possible to specify whether the command value telegram for heating of the second control circuit is output normally or in inverted form. This parameter is only visible if the operating mode "Heating" and two control circuits are configured.</p>
Output of the cooling variable	<p>Inverted (under current, this means closed)</p> <p>Normal (under current, this means opened)</p>	<p>At this point, it is possible to specify whether the command value telegram for cooling is output normally or in inverted form. This parameter is only visible if the operating mode "Cooling" or "Heating and cooling" is configured and not two-level operation.</p>
Output of the command value basic level cooling	<p>Inverted (under current, this means closed)</p> <p>Normal (under current, this means opened)</p>	<p>At this point, it is possible to specify whether the command value telegram for the cooling basic level is output normally or in inverted form. This parameter is only visible if the operating mode "Cooling" or "Heating and cooling" is configured along with two-level operation.</p>

Output of the cooling additional stage variable	Inverted (under current, this means closed) Normal (under current, this means opened)	At this point, it is possible to specify whether the command value telegram for the cooling additional level is output normally or in inverted form. This parameter is only visible if the operating mode "Cooling" or "Heating and cooling" is configured along with two-level operation.
Output of the cooling command value in control circuit 1	Inverted (under current, this means closed) Normal (under current, this means opened)	At this point, it is possible to specify whether the command value telegram for cooling of the first control circuit is output normally or in inverted form. This parameter is only visible if the operating mode "Cooling" and two control circuits are configured.
Output of the cooling command value in control circuit 2	Inverted (under current, this means closed) Normal (under current, this means opened)	At this point, it is possible to specify whether the command value telegram for cooling of the second control circuit is output normally or in inverted form. This parameter is only visible if the operating mode "Cooling" and two control circuits are configured.
Command value limit	deactivated continuously activated can be activated via object	The command value limit allows the restriction of calculated command values to the range limits "minimum" and "maximum". The limits are permanently set in the ETS and, if command value limitation is active, can be neither undershot or exceeded during device operation. The "Command value limit" parameter defines the mode of action of the limiting function. The command value limit can either be activated or deactivated using the 1-bit communication object "Command value limit", or be permanently active.
Command value limit after reset	deactivated activated	When controlling via the object, it is possible to have the controller activate the command value limit automatically after bus voltage return or an ETS programming operation. This parameter defines the initialisation behaviour here. In the "Deactivated" setting, the command value limit is not automatically activated after a device reset. A "1" telegram must first be received via the "Command value limit" object for the limit to be activated.

		<p>In the "Activated" setting, the controller activates the command value limit automatically after a device reset. To deactivate the limit a "0" telegram must be received via the "Command value limit" object. The limit can be switched on or off at any time using the object. This parameter is only visible with "Command value limit = can be activated via object"!</p>
<p>Minimum command value for heating (optionally control circuit 1) (optionally also for basic and additional level)</p>	<p>5%, 10%, 15%, 20%, 25%, 30%, 35%, 40%, 45%, 50%</p>	<p>The "Minimum command value" parameter specifies the lower command value limiting value for heating. With an active command value limit, the set minimum command value is not undershot by command values. If the controller calculates smaller command values, it sets the configured minimum command value. The controller transmits a 0 % command value if no more heating or cooling energy has to be demanded.</p>
<p>Maximum command value for heating (optionally control circuit 1) (optionally also for basic and additional level)</p>	<p>55%, 60%, 65%, 70%, 75%, 80%, 85%, 90%, 95%, 100%</p>	<p>The "Maximum command value" parameter specifies the upper command value limiting value for heating. With an active command value limit, the set maximum command value is not exceeded. If the controller calculates larger command values, it sets the configured maximum command value.</p>
<p>Minimum command value for heating Control circuit 2</p>	<p>5%, 10%, 15%, 20%, 25%, 30%, 35%, 40%, 45%, 50%</p>	<p>The "Minimum command value" parameter specifies the lower command value limiting value for heating. With an active command value limit, the set minimum command value is not undershot by command values. If the controller calculates smaller command values, it sets the configured minimum command value. The controller transmits a 0 % command value if no more heating or cooling energy has to be demanded. This parameter is only visible with two control circuits!</p>
<p>Maximum command value for heating Control circuit 2</p>	<p>55%, 60%, 65%, 70%, 75%, 80%, 85%, 90%, 95%, 100%</p>	<p>The "Maximum command value" parameter specifies the upper command value limiting value for heating. With an active command value limit, the set maximum command value is not exceeded. If the controller calculates larger command values, it sets the configured maximum command value.</p>

This parameter is only visible with two control circuits!

Minimum command value for cooling (optionally control circuit 1) (optionally also for basic and additional level)

5%, 10%, 15%, 20%, 25%, 30%, 35%, 40%, 45%, 50%

The "Minimum command value" parameter specifies the lower command value limiting value for cooling. With an active command value limit, the set minimum command value is not undershot by command values. If the controller calculates smaller command values, it sets the configured minimum command value. The controller transmits a 0 % command value if no more heating or cooling energy has to be demanded.

Maximum command value for cooling (optionally control circuit 1) (optionally also for basic and additional level)

55%, 60%, 65%, 70%, 75%, 80%, 85%, 90%, **95%**, 100%

The "Maximum command value" parameter specifies the upper command value limiting value for cooling. With an active command value limit, the set maximum command value is not exceeded. If the controller calculates larger command values, it sets the configured maximum command value.

Minimum command value for cooling Control circuit 2

5%, 10%, 15%, 20%, 25%, 30%, 35%, 40%, 45%, 50%

The "Minimum command value" parameter specifies the lower command value limiting value for cooling. With an active command value limit, the set minimum command value is not undershot by command values. If the controller calculates smaller command values, it sets the configured minimum command value. The controller transmits a 0 % command value if no more heating or cooling energy has to be demanded.
This parameter is only visible with two control circuits!

Maximum command value for cooling Control circuit 2

55%, 60%, 65%, 70%, 75%, 80%, 85%, 90%, **95%**, 100%

The "Maximum command value" parameter specifies the upper command value limiting value for cooling. With an active command value limit, the set maximum command value is not exceeded. If the controller calculates larger command values, it sets the configured maximum command value.
This parameter is only visible with two control circuits!

Heating indication

	<p>Yes No</p>	<p>Depending on the set operating mode, a separate object can be used to signal whether the controller for the first control circuit is currently demanding heating energy and is thus actively heating. The "Yes" setting here enables the message function for heating.</p>
Cooling indication	<p>Yes No</p>	<p>Depending on the set operating mode, a separate object can be used to signal whether the controller for the first control circuit is currently demanding cooling energy and is thus actively cooling. The "Yes" setting here enables the message function for cooling.</p>
Controller status	<p>no status KNX compliant Controller general transmit individual state</p>	<p>The room temperature controller can transmit its current status to the KNX/EIB. A choice of data formats is available for this. This parameter enables the status signal and sets the status format.</p>
Single status	<p>Comfort mode Active Standby mode activated Night mode activated Frost/heat protection active Controller disabled Heating / cooling Controller inactive Frost alarm</p>	<p>Here, the status information is defined, which is to be transmitted onto the bus as the 1-bit controller status. This parameter is only visible if the parameter "Controller status" is set to "Transmit single status".</p>
Behaviour when command value = 100% (Clipping mode)	<p>keep 100% until setpoint = actual, then 0% keep 100% as required, then adjust downwards</p>	<p>If with a PI control the calculated command value of the controller exceeds the physical limits of the actuator, in other words if the calculated command value is greater than 100%, then the command value is set to the maximum value (100%) and thus limited. With PI control the command value can reach the value "100%" if there is a large deviation of the room temperature from the setpoint temperature or the controller requires a long time to adjust to the setpoint with</p>

the heating or cooling energy that is being applied. The controller can evaluate this state in a particular manner and react to it in various ways. This parameter defines the functions of the PI controller when the command value is 100%.

"keep 100% until setpoint = actual, then 0%" setting:
The controller keeps the maximum command value until the room temperature (actual value) reaches the setpoint temperature. After that, it reduces the command value down to 0% all at once (controller reset). The advantage of this control behaviour is that in this way sustainable heating up of undercooled rooms or effective cooling of overheated rooms will be achieved by overshooting the setpoint. The disadvantage is the in some circumstances the overshooting of the room temperature may be found disturbing.

Setting "keep 100% as required, then adjust downwards":
The controller maintains the maximum command value only as long as it is necessary. After that, it adjusts the command value downwards according to the PI algorithm. The advantage of this control characteristic is the fact that the room temperature does not exceed the setpoint temperature at all, or only slightly. The disadvantage is that this control principle increases the tendency to oscillate about the setpoint.

Setpoint values

Overwrite setpoints in device after ETS programming operation?	Yes
	No

The temperature setpoints programmed in the room temperature controller by the ETS during commissioning can be changed via communication objects. This parameter can be used to define whether the setpoints present in the device, which may have been changed subsequently, are overwritten during an ETS programming operation and thus replaced again by the values parameterised in the ETS. If this parameter is on "Yes", then the temperature setpoints are deleted in the device during a programming operation and replaced by the values of the ETS. If this parameter is configured to "No", then setpoints present in the device remain unchanged. The setpoint temperatures entered in the ETS then have no significance.

Setpoint presetting	<p>relative (setpoint temperatures from basic setpoint)</p> <p>absolute (independent setpoint temperatures)</p>	<p>It is possible to configure the setpoints for the "Comfort", "Standby" and "Night" modes directly (absolute setpoint presetting) or relatively (derivation from basic setpoint). This parameter defines the way the setpoint temperature is preset.</p> <p>With "Relative": All temperature setpoints are derived from the basic temperature (basic setpoint).</p> <p>With "Absolute": The setpoint temperatures are independent of each other. Different temperature values can be specified for each operating mode and heating/cooling mode.</p>
Step width of the setpoint shift	<p>0.1 K</p> <p>0.5 K</p> <p>1.0 K</p>	<p>This parameter defines the step width of the setpoint shift.</p> <p>For a setpoint shift to remain in sensible steps when a new setpoint is received by the "Basic setpoint", it is adjusted to the step width to be adjusted. For example, in the case of a step value of 0.5 K for the setpoint shift, a received basic setpoint value is rounded in such a way that it has a 0 or 0.5 after the decimal point. This applies in the same way to step values of 0.1 K.</p>
Basic temperature after reset	<p>7...21...40</p>	<p>This parameter defines the temperature value to be applied as the basic setpoint after commissioning by the ETS. All the temperature setpoints are derived from the basic setpoint.</p>
Permanently apply change to basic setpoint shift	<p>No</p> <p>Yes</p>	<p>In the "Yes" setting, the shift of the basic setpoint carried out affects all operating modes. The shift is maintained even after a switchover of the operating mode or the heating/cooling mode or adjusting the basic setpoint.</p> <p>In the "No" setting, the basic setpoint shift carried out is in effect for only as long as the operating mode or heating/cooling mode has not changed or the basic setpoint is maintained. Otherwise the setpoint shift will be reset to "0".</p>

Modification of the basic temperature setpoint value	deactivated approve via bus	Here, it is possible to specify if it is possible to change the basic setpoint via the KNX. In the "Approve" setting, the "Basic setpoint" object is visible in the ETS.
Accept modification of the basic temperature setpoint value permanently	No Yes	<p>One has to distinguish between two cases, defined by this parameter, if the basic setpoint has been modified (via local control or via the object):</p> <p>In the "Yes" setting, the controller saves the basic setpoint permanently in the EEPROM. The newly adjusted value will overwrite the basic temperature originally configured via the ETS after a reset! This is the only way to keep the adjusted basic setpoint even after change-over of the operating mode or after a reset.</p> <p>In the "No" setting, the basic setpoint, which was set on the room temperature controller or received via the object, stays only temporarily active in the current operating mode. In case of a bus voltage failure or following a change-over to another operating mode (e.g. Comfort followed by Standby), the basic setpoint set via local control or received via the object will be discarded and replaced by the value which was originally configured in the ETS.</p>
Frost protection setpoint temperature	7...40	This parameter specifies the setpoint temperature for frost protection. The parameter is only visible in "Heating" or "Heating and cooling" operating modes (if necessary with additional levels).
Heat protection setpoint temperature	7...35...45	This parameter specifies the setpoint temperature for heat protection. The parameter is only visible in "Cooling" or "Heating and cooling" operating modes (if necessary with additional levels).
Dead band position	symmetrical asymmetrical	<p>The comfort setpoint temperatures for "Heating and cooling" operating modes are derived from the basic setpoint in consideration of the adjusted deadband. The deadband (temperature zone for which there is neither heating nor cooling) is the difference between the comfort setpoint temperatures.</p> <p>Symmetrical setting: the deadband preset in the ETS plug-in is divided in two parts at the basic setpoint. The</p>

comfort setpoint temperatures are derived directly from the basic setpoint resulting from the half deadband (Basic setpoint - 1/2 deadband = Heating comfort temperature or Basic setpoint + 1/2 deadband = Cooling comfort temperature).

Asymmetrical setting: with this setting the comfort setpoint temperature for heating equals the basic setpoint! The preset deadband is effective only from the basic setpoint in the direction of comfort temperature for cooling. Thus the comfort set-temperature for cooling is derived directly from the comfort setpoint for heating.
The parameter is only visible in "Heating and cooling" operating modes (if necessary with additional levels).

Dead band between heating and cooling 0 ... **20** ... 255

The comfort setpoint temperatures for heating and cooling are derived from the basic setpoint in consideration of the adjusted deadband. The deadband (temperature zone for which there is neither heating nor cooling) is the difference between the comfort setpoint temperatures. It is set using this parameter.
The parameter is only visible in "Heating and cooling" operating modes (if necessary with additional levels).

Upward adjustment of the basic setpoint temperature 0 K
+ 1 K
+ 2 K
+ 3 K
+ 4 K
+ 5 K
+ 8 K
+ 9 K
+ 10 K

This is used to define the maximum range in which the basic setpoint temperature can be adjusted upwards. This parameter is only visible with relative setpoint presetting!

Downward adjustment of the basic setpoint temperature 0 K
- 1 K
- 2 K
- 3 K
- 4 K
- 5 K
- 8 K
- 9 K
- 10 K

-128...**-20**...0

This is used to define the maximum range in which the basic setpoint temperature can be adjusted downwards. This parameter is only visible with relative setpoint presetting!

Lower the setpoint temperature during standby operating mode (heating)		The value by which the standby setpoint temperature for heating is lowered compared to the heating comfort temperature. The parameter is only visible in "Heating" or "Heating and cooling" operating modes (if necessary with additional levels).
Lower the setpoint temperature during Night mode (heating)	-128... -40 ...0	The value by which the night setpoint temperature for heating is lowered compared to the heating comfort temperature. The parameter is only visible in "Heating" or "Heating and cooling" operating modes (if necessary with additional levels).
Raise the setpoint temperature during standby operating mode (cooling)	0... 20 ...127	The value by which the standby setpoint temperature for cooling is lowered compared to the cooling comfort temperature. The parameter is only visible in "Cooling" or "Heating and cooling" operating modes (if necessary with additional levels).
Raise the setpoint temperature during Night mode (cooling)	0... 40 ...127	The value by which the night temperature for cooling is lowered compared to the cooling comfort temperature. The parameter is only visible in "Cooling" or "Heating and cooling" operating modes (if necessary with additional levels).
Frost protection setpoint temperature	7...40	This parameter specifies the setpoint temperature for frost protection. The parameter is only visible in "Heating" or "Heating and cooling" operating modes (if necessary with additional levels).
Heat protection setpoint temperature	7... 35 ...45	This parameter specifies the setpoint temperature for heat protection. The parameter is only visible in "Cooling" or "Heating and cooling" operating modes (if necessary with additional levels).
Difference between basic and additional levels	0 ... 20 ... 255	In a two stage control mode it is necessary to determine the temperature difference to the basic stage with which the additional stage is to be incorporated into the control. This parameter defines

		the level spacing. The parameter can only be seen in two-level control operation.
Transmission at setpoint temperature change by	0...1...255	Determines the size of the value change required to automatically transmit the current value via the "Setpoint temperature" object. In the "0" setting, the setpoint temperature is not transmitted automatically when there is a change.
Cyclical transmission of setpoint temperature 0 = inactive	0...255	This parameter determines whether the setpoint temperature is to be transmitted periodically via the "Setpoint temperature" object. Definition of the cycle time by this parameter In the "0" setting, the setpoint temperature is not transmitted automatically cyclically.
Change-over between heating and cooling	Automatic Via object (heating/cooling change-over)	In a configured mixed mode it is possible to switch over between heating and cooling. With "Automatic": Depending on the operating mode and the room temperature, the change-over takes place automatically. With "via object (heating/cooling change-over)": The change-over takes place only via the object "Heating/cooling change-over". With automatic setpoint presetting this parameter is permanently set to "Via object (heating/cooling change-over)"!
Heating / cooling mode after a reset	Heating Cooling Operating mode before reset	The preset operating mode for after the return of the bus voltage is specified here. Only visible if "Switchover between heating and cooling = via object"!
Automatic heating/cooling transmission switchover	On changing the operating mode On changing the output value	Here, it is possible to specify when a telegram is transmitted automatically onto the bus via the object "Heating / cooling change-over". Only visible if "Change-over between heating and cooling = automatic".
Cyclical transmission heating/cooling change-over 0 = inactive	0...255	This parameter specifies whether the current object status of the "Heating / cooling change-over" object should be output cyclically to the bus on an

Setpoint temperature limit in cooling operation	<p>no limit</p> <p>Only difference to outdoor temperature</p> <p>Only max. setpoint temperature</p> <p>Max. setpoint and difference to outdoor temperature</p>	<p>automatic change-over. The cycle time can be set here. The "0" setting deactivates the periodic transmission of the object value. Only visible if "Change-over between heating and cooling = automatic".</p> <p>Optionally, the setpoint temperature limit can be enabled here, which is only effective in cooling operation. If necessary, the controller limits the setpoint temperature to specific values and prevents an adjustment beyond the limits.</p> <p>"Only difference to outdoor temperature" setting, the outdoor temperature is monitored and compared to the active setpoint temperature in this setting. The specification of the maximum temperature difference to the outdoor temperature is made using the "Difference to outdoor temperature in cooling mode" parameter. If the outdoor temperature rises above 32 °C, then the controller activates the setpoint temperature limit. It then permanently monitors the outdoor temperature and raises the setpoint temperature so that is beneath the outdoor temperature by the amount configured. Should the outdoor temperature continue rise, the controller raises the setpoint temperature until the required difference to the outdoor temperature is achieved, or, at most, the heat protection temperature. It is then not possible to undershoot the raised setpoint, e.g. by changing the basic setpoint change. The change to the setpoint temperature limit is temporary. It only applies for as long as the outdoor temperature exceeds 32 °C.</p> <p>"Only max. setpoint temperature" setting: In this setting, no setpoint temperatures are permitted in Cooling mode related to the Comfort, Standby and Night modes, which are greater than the maximum setpoints configured in the ETS. The maximum temperature setpoint is specified by the "Max. setpoint temperature in cooling operation" parameter. With an active limit, no larger setpoint can be set in cooling operation, e.g. by a basic setpoint change or a setpoint shift. However, heat protection is not influenced by the setpoint temperature</p>
---	---	---

		limit.	<p>"Max. setpoint temperature and difference to outdoor temperature" setting: This setting is a combination of the two above-mentioned settings. In the downward direction, the setpoint temperature is limited by the maximum outdoor temperature difference, whilst in the upward direction, the limit is made by the maximum setpoint. The maximum setpoint temperature has priority over the outdoor temperature difference. This means that the controller keeps on raising the setpoint temperature upwards according to the difference to the outdoor temperature configured in the ETS until the maximum setpoint temperature or the heat protection temperature is exceeded. Then the setpoint is limited to the maximum value.</p>
Activation of the setpoint temperature limit in cooling operation via object	No Yes		<p>A setpoint limit enabled in the ETS can be activated or deactivated as necessary using a 1-bit object. For this, this parameter can be set to "Yes". In this case, the controller only takes the setpoint limit into account, if it has been enabled via the object "Cooling setpoint temp. limit" ("1" telegram). If the limitation is not enabled ("0" telegram), the cooling setpoint temperatures are not limited.</p> <p>This parameter is visible only if setpoint temperature monitoring is enabled.</p>
Difference to outdoor temperature in cooling operation	1 K... 6 K ...15 K		<p>This parameter defines the maximum difference between the setpoint temperature in Comfort mode and the outdoor temperature with an active setpoint temperature limit.</p> <p>This parameter is visible only if setpoint temperature monitoring is enabled. However, this is only if the parameter "Setpoint temperature limit in cooling operation" is then set to "Only difference to outdoor temperature" or "Max. setpoint temperature and difference to outdoor temperature".</p>
Max. setpoint temperature in cooling operation	20°C... 26°C ...35°C		<p>This parameter defines the maximum setpoint temperature in Comfort mode with an active setpoint temperature limit. This parameter is visible only if setpoint temperature monitoring is enabled. However, this is only if the parameter "Setpoint temperature limit in cooling</p>

operation" is then set to "Only max. setpoint temperature" or "Max. setpoint temperature and difference to outdoor temperature".

□ Controller functionality

Presence detection	<p>none</p> <p>Presence detector</p>	<p>In the "None" setting, the presence mode is deactivated.</p> <p>In the "Presence detector" setting, presence detection takes place using an external presence detector, coupled to the presence object. Comfort mode is recalled when a presence is detected. Comfort mode remains active until the presence detector ceases to detect movement. In this setting, a presence button on the device has no function.</p>
Switch off controller (dew point operation)	<p>No</p> <p>via bus</p>	<p>This parameter enables the "Disable controller" object. If the controller is disabled, there is no feedback control until enabled in both control circuits (command values = 0). An activated controller disable (dew point operation) is shown in the display.</p>
Underfloor heating temperature limit	<p>not present</p> <p>present</p>	<p>This parameter enables the "Floor temperature" object. This communication object is an input or an output object, depending on the function of the input.</p> <p>If the input executes the function "Temperature limiter, underfloor heating", then the device measures the temperature via the temperature sensor connected at the input. The device executes the function "Underfloor heating temperature limiting" with the measured temperature value. The measured temperature can be transmitted to the KNX via the "Floor temperature" output object.</p> <p>If the input does not work as "Temperature limiter, underfloor heating", then a valid temperature must be specified for the device via the input object "Floor temperature". The device executes the function "Underfloor heating temperature limiting" with the received temperature value.</p> <p>Additional parameters become visible in the "Available" setting.</p>

Effect on	Heating, basic level Heating, additional level	This parameter defines via which command value the temperature limiting (underfloor heating) is activated.
Maximum temperature, underfloor heating	20 ... 30 ... 70	This parameter specifies the maximum temperature value of the underfloor heating. If the temperature in the floor exceeds this value, the command value of the heating is set to "0", in order to prevent excessive heating of the floor.
Hysteresis of limit temperature	1 K	The heating command value is re-enabled if the temperature in the floor falls below the limiting value "Maximum temperature, underfloor heating" minus the hysteresis. The hysteresis value is permanently set to 1 K.

4.2.5.6 Temperature limiting value

Description	Values	Comment
□- Temperature limiting value functionality (only for application program version "1.2")		
Limit value monitoring	Not used Remote sensor measured value (object 32) Internal sensor measured value (object 30) Temperature measurement actual temperature value (object 35)	This parameter enables the limiting value monitoring of a temperature value and determines which temperature value is monitored. The temperature values "Remote sensor measured value", "Internal sensor measured value" or "Temperature measurement actual temperature value" can be monitored. The parameter "Limiting value monitoring" is not checked for plausibility. For this reason, make sure that the parameterised object is actually enabled. The objects are enabled depending on the setting of the parameters "Function input" (parameter page "Input") and "Temperature detection by" (parameter page "Room temperature measurement"). ⓘ For a functioning limiting value monitoring, the selected object must actually be enabled.
Limiting value (°C)	0 ... 20 ... 50	This parameter specifies the limiting value of the temperature, which must be exceeded or undershot so that the communication object "G.Output temperature limiting value" optionally sends a telegram (polarity can be set) to the KNX. The parameter "Limiting value function" defines whether the KNX telegram is transmitted when the value is exceeded or undershot.
Hysteresis (K)	2 ... 3 ... 10	Definition of the hysteresis of the limiting value in °C of the limiting value monitoring.
Limit value function	No action Exceed LV=ON, undershoot LV-hyst.=OFF Exceed LV=OFF, Undershoot LV-hyst.=ON Undershoot LV=ON, exceed LV+hyst.=OFF Undershoot LV=OFF, exceed LV+hyst.=ON	This parameter defines the action which is to be executed when the limiting value is exceeded or undershot from a defined direction.

	<p>Exceed LV=ON, undershoot LV-hyst.=no telegr.</p> <p>Exceed LV=OFF, Undershoot LV-hyst.=no telegr.</p> <p>Undershoot LV=ON, exceed LV+hyst.=no telegr.</p> <p>Undershoot LV=OFF, exceed LV+hyst.=no telegr.</p> <p>Exceed LV=no telegr., Undershoot LV-hyst.=OFF</p> <p>Exceed LV=no telegr., Undershoot LV-hyst.=ON</p> <p>Undershoot LV=no telegr., Exceed LV+hyst.=OFF</p> <p>Undershoot LV=no telegr., Exceed LV+hyst.=ON</p>	<p>i In conjunction with the parameters "Limiting value (°C)" and "Hysteresis (K)", the thresholds are defined at which the communication object "G.Output temperature limiting value" is set to "1"/"ON" or to "0"/"OFF" when the thresholds are exceeded or undershot.</p>
Type of the limiting value object	<p>1 bit, DPT 1.001</p> <p>1 byte, DPT 5.010</p>	<p>This parameter specifies the data format of the limiting value object "G.Output temperature limiting value". The 1-bit limiting value object sends a "1" or a "0" to the KNX according to the defined thresholds. The 1-byte limiting value object sends configurable values between 0 and 255 to the KNX according to the defined thresholds. These values define the parameters "Value at ON" and "Value at OFF".</p>
Value at ON	<p>0 ... 255</p>	<p>This parameter defines a value between 0 and 255. In accordance with the defined thresholds this value is transmitted to the KNX at "ON" via the limiting value object "G.Output temperature limiting value".</p>
Value at OFF	<p>0 ... 255</p>	<p>This parameter defines a value between 0 and 255. In accordance with the defined thresholds this value is transmitted to the KNX at "OFF" via the limiting value object "G.Output temperature limiting value".</p>
Switch-on delay	<p>No delay</p> <p>1 s delay</p>	<p>Only after the time set here will the current state of the limiting value be accepted in the limiting value object.</p>

	<p>3 s delay</p> <p>5 s delay</p> <p>10 s delay</p> <p>15 s delay</p> <p>30 s delay</p> <p>1 min delay</p> <p>3 min delay</p> <p>5 min delay</p> <p>10 min delay</p> <p>15 min delay</p> <p>30 min delay</p> <p>60 min delay</p>	<p>This means that a change in the limiting value to "1" will only be sent after this time elapses; in the case of cyclical transmission of the limiting value, the changed value "1" is only sent after this time elapses. Therefore a "0" continues to be sent while the timer for the delay time is running.</p> <p>i If the parameter "Limiting value function" for a condition is set to "No telegram", then the cyclical telegrams are also suppressed when the set condition is fulfilled.</p>
Switch-off delay	<p>No delay</p> <p>1 s delay</p> <p>3 s delay</p> <p>5 s delay</p> <p>10 s delay</p> <p>15 s delay</p> <p>30 s delay</p> <p>1 min delay</p> <p>3 min delay</p> <p>5 min delay</p> <p>10 min delay</p> <p>15 min delay</p> <p>30 min delay</p> <p>60 min delay</p>	<p>Only after the time set here will the current state of the limiting value be accepted in the limiting value object. This means that a change in the limiting value to "0" will only be sent after this time elapses; in the case of cyclical transmission of the limiting value, the changed value "0" is only sent after this time elapses. Therefore a "1" continues to be sent while the timer for the delay time is running.</p> <p>i If the parameter "Limiting value function" for a condition is set to "No telegram", then the cyclical telegrams are also suppressed when the set condition is fulfilled.</p>
Transmit on change	<p>Yes</p> <p>No</p>	<p>The limiting value object is sent following a change from "0" to "1" or from "1" to "0" if this parameter is set to "Yes". The limiting value object is not sent following a change if this parameter is set to "No". If the parameter "Cyclical</p>

transmission (x 10 seconds)" is set to at least 1, then the limiting value object is sent cyclically regardless of any change.

- i** If this parameter is set to "No" and the parameter "Cyclical transmission (x 10 seconds)" is set to "0", then the limiting value is not transmitted at all.

Cyclical transmission (x 10 seconds) **0** ... 144

This parameter defines whether and at what time interval the limiting value is cyclically transmitted. The set value multiplied by 10 is the repeat time in seconds. It is thus possible to set the cycle time in step widths of 10 seconds. The value "0" indicates that the limiting value object is not transmitted cyclically.

- i** If the parameter "Transmission on change" is set to "No" and this parameter is set to "0", then the limiting value is not transmitted at all.

5 Appendix

5.1 Index

Numerical	
2-point feedback control.....	97
A	
Accept setpoints permanently.....	116
actual temperature.....	83
Adapting.....	95,97
Additional controller status.....	123
Adjustment error.....	49
automatic frost protection.....	105
Automatic operation.....	128
Automatic transmission.....	120
B	
Basic setpoint shift.....	116
Brightness value transmitter.....	74
C	
Calibrating.....	82
Clipping.....	126
Comfort extension.....	104
command value limit.....	63
Command value limiting values.....	132
Command value objects.....	119
command value offset.....	132
Command value status.....	52
control algorithm.....	88
Controller status.....	121
D	
Default position.....	47
dew point mode.....	134
Dimming.....	71
Dimming value transmitter.....	74
disabling function.....	78
E	
Emergency operation.....	56
ETS search paths.....	14
F	
fan controller.....	127
Fan level limit.....	131
Fan protection.....	133
Forced fan position.....	132
H	
Heating/cooling message.....	87
I	
intelligent valve rinsing.....	60
L	
Light scene extension.....	74
Limiting value.....	65
Limiting value monitoring.....	135
M	
manual operation.....	128
measured value formation.....	81
mixed operating mode.....	86
Monitoring.....	56
O	
Operating mode.....	51
operating mode after a reset.....	106
Operating mode switch-over.....	99
operating modes.....	85
operation modes.....	128
P	
PI control.....	89,95
Presence function.....	104
Programming/status LED.....	12
S	
Self-adjustment.....	49
Setpoint temperature presetting.....	107
Setpoint temperatures.....	108
single operating modes.....	85
Switching.....	69
Switching 2-point feedback control.....	91
Switching PI control.....	89
Switch-on level.....	130
T	
Telegram rate limit.....	46
Temperature detection.....	81
temperature limiting value.....	135
Temperature value transmitter.....	74
U	
Underfloor heating temperature limit.....	83

V

Value transmitter function.....	74
valve rinsing function.....	58
Venetian blind.....	72

W

window status.....	105
--------------------	-----

Gira
Giersiepen GmbH & Co. KG
Elektro-Installations-
Systeme

Industriegebiet Mermbach
Dahlienstraße
42477 Radevormwald

Postfach 12 20
42461 Radevormwald

Deutschland

Tel +49(0)21 95 - 602-0
Fax +49(0)21 95 - 602-191

www.gira.de
info@gira.de