

Issue:
10.01.2023
50233400

Switching actuator / blind actuator 16 A Standard
Order no. 5023 00, 5028 00, 5030 00

Table of Contents

1	Information on the product	5
1.1	Product catalogue	5
1.2	Function	5
1.3	Device components	7
1.4	Technical data.....	8
2	Safety instructions	10
3	Mounting and electrical connection	11
4	Commissioning	13
5	Application programs	15
6	Scope of functions	16
7	Notes on software	18
8	Operation and indication	19
8.1	Button operation and indication functions	19
8.2	ETS configuration	24
8.2.1	Manual operation	24
8.2.2	Status indication	26
8.3	Operation and indication parameters.....	28
9	General	31
9.1	Parameters for heartbeat.....	31
9.2	Object list for heartbeat.....	31
10	Channel configuration	32
10.1	Channel configuration parameters.....	34
11	Venetian blind operation	35
11.1	Priorities	35
11.2	General settings.....	36
11.2.1	Reset behaviour	36
11.2.2	Safety functions	38
11.2.3	Name of a Venetian blind output	44
11.3	Operating mode	45
11.3.1	Operating mode parameters.....	46
11.4	Reset and initialisation behaviour	47
11.4.1	Reset and initialisation behaviour parameter	48
11.5	Short-time / Long-time operation, travel times	49
11.5.1	Short-time / Long-time operation	49

11.5.2	Setting the travel time	50
11.5.3	Setting slat travel times (with slatted Venetian blinds)	51
11.5.4	Presetting the travel time extension and switchover time.....	52
11.5.5	Short-time / Long-time operation, travel times parameter	53
11.5.6	Object list Short-time / Long-time operation, travel times	55
11.6	Position calculation, position presetting and feedbacks	56
11.6.1	Position calculation and position presetting.....	56
11.6.2	Feedback telegrams	63
11.6.3	Parameter position calculation, position presetting and feedbacks	70
11.6.4	Object list position calculation, position presetting and feedbacks	75
11.7	Safety functions	78
11.7.1	Safety functions parameters	83
11.7.2	Object list safety functions	86
11.8	Sun protection function	87
11.8.1	Sun protection function parameters.....	100
11.8.2	Object sun protection function	109
11.9	Twilight function	110
11.9.1	Parameters for the twilight function	112
11.9.2	Object list for twilight function	114
11.10	Scene function	115
11.10.1	Scene function parameters.....	119
11.10.2	Object list scene function.....	122
11.11	Disabling function and forced position	123
11.11.1	Disabling function and forced position parameters.....	128
11.11.2	Object list disabling function and forced position.....	136
12	Switching operation	137
12.1	Priorities	137
12.2	General settings.....	138
12.2.1	Reset behaviour	138
12.2.2	Name of a switching output	139
12.3	Operating mode	140
12.3.1	Operating mode parameters.....	141
12.3.2	Object list operating mode.....	141
12.4	Reset and initialisation behaviour	142
12.4.1	Reset and initialisation behaviour parameter	143
12.5	Feedback telegrams	144
12.5.1	Feedback telegrams parameter.....	148
12.5.2	Feedback object list.....	150

12.6	Time delays.....	152
12.6.1	Time delays parameters	153
12.7	Staircase function	154
12.7.1	Staircase function parameters	158
12.7.2	Object list staircase function	160
12.8	Scene function	161
12.8.1	Scene function parameters.....	165
12.8.2	Object list scene function.....	167
12.9	Disabling function and forced position	168
12.9.1	Disabling function and forced position parameters.....	172
12.9.2	Object list disabling function and forced position.....	176
12.10	Logic operation function.....	177
12.10.1	Logic operation function parameters	179
12.10.2	Object list logic operation function	180
13	As-delivered state	181

1 Information on the product

1.1 Product catalogue

Product name: Switching actuator / blind actuator 16 A Standard

Use: Actuator

Design: RMD

Order no. 5023 00, 5028 00, 5030 00

1.2 Function

The switch actuator / Venetian blind actuator receives telegrams from sensors or other controls via the KNX and switches electrical loads. The relay outputs of the actuator can be set in the ETS either to Venetian blind operation (2 relay outputs per channel) or alternatively (1 relay output per channel) to switching operation; mixed operation of these two operating modes is also possible on the device.

In Venetian blind operation the actuator can be used with its relay contacts to control electrically driven Venetian blinds, shutters, awnings, roof windows, venting louvres or similar blinds/shutters that are suitable for mains voltage. Alternatively, the actuator in switching operation switches electrical loads, such as lighting systems or door openers.

Each relay output has bus-powered bistable switching relays, which allows defined preferred positions in the event of bus voltage failure/recovery and after an ETS programming operation.

The buttons on the front panel of the device permit switching the relays on and off by hand in parallel during KNX operation or activated in a non-programmed state. This feature permits fast checking of connected loads for proper functioning.

The functionalities that can be preset in the ETS in Venetian blind operation include, for instance, independently parameterisable travel times, extended feedback functions, assignment to up to 5 different safety functions, an extensive sun protection function, and incorporation into scenes and disabling functions.

In switching operation the functionalities NC contact or NO contact include, for example, extensive time functions, logic operations, scenes and disabling functions. In addition, the switching status of a relay output can be signalled back.

The device can be updated. Firmware can be easily updated with the Gira ETS Service App (additional software).

The device is KNX Data Secure capable. KNX Data Secure offers protection against manipulation in building automation and can be configured in the ETS project. Detailed specialist knowledge is required. A device certificate, which is attached to the device, is required for safe commissioning. During mounting, it is recommended to remove the certificate from the device and to store it securely.

Planning, installation and commissioning of the device are carried out with the aid of the ETS, version 5.7.3 and above or of the ETS6.

The device electronics are supplied exclusively from the bus voltage. The device is designed for mounting on DIN-rails in closed compact boxes or in power distributors in fixed installations in dry rooms.

1.3 Device components

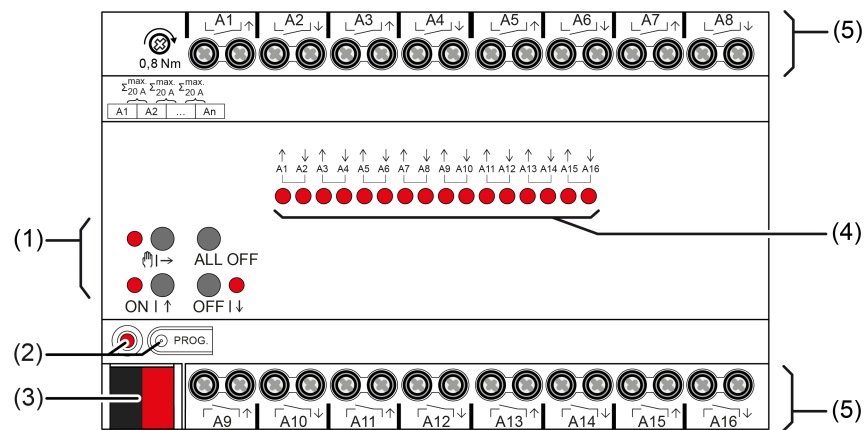

Image 1: Device components

- (1) Button field for manual operation
- (2) Programming button and LED
- (3) KNX connection
- (4) Status LEDs for outputs
- (5) Load connections (relay outputs)

1.4 Technical data

Ambient conditions	
Ambient temperature	-5 ... +45 °C
Storage/transport temperature	-25 ... +70 °C
KNX	
KNX medium	TP256
Commissioning mode	S-mode
Rated voltage KNX	DC 21 ... 32 V SELV
Current consumption KNX	
Order no. 5023 00, 5028 00	5 ... 18 mA
Order no. 5030 00	5 ... 24 mA
Outputs	
Switching voltage	AC 250 V ~
Switching current AC1	16 A
Fluorescent lamps	16 AX
Current carrying capacity	
Neighbouring outputs	Σ 20 A
Loads per output	
Ohmic load	3000 W
Capacitive load	max. 16 A (140 μ F)
Motors	1380 VA
Switch-on current 200 μ s	max. 800 A
Switch-on current 20 ms	max. 165 A
Lamp loads	
Incandescent lamps	2300 W
HV halogen lamps	2300 W
HV-LED lamps	max. 400 W
LV halogen lamps with electronic transformers	1500 W
LV halogen lamps with inductive transformer	1200 VA
Compact fluorescent lamps	
uncompensated	1000 W
parallel compensated	1160 W (140 μ F)
Installation width	
Order no. 5023 00	72 mm / 4 HP
Order no. 5028 00	144 mm / 8 HP

Order no. 5030 00	216 mm / 12 HP
Weight	
Order no. 5023 00	approx. 230 g
Order no. 5028 00	approx. 500 g
Order no. 5030 00	approx. 740 g
Clampable conductor cross-section	
Single stranded	0.5 ... 4 mm ²
Finely stranded without conductor sleeve	0.5 ... 4 mm ²
Finely stranded with conductor sleeve	0.5 ... 2.5 mm ²
Connection torque, screw terminals	max. 0.8 Nm

2 Safety instructions



Electrical devices may only be mounted and connected by electrically skilled persons.

Danger of electric shock. Device is not suitable for disconnection from supply voltage.

Danger of electric shock on the SELV/PELV installation. Do not connect loads for mains voltage and SELV/PELV together to the device.

Serious injuries, fire or property damage possible. Please read and follow manual fully.

Do not connect any three-phase motors. Device can be damaged.

For parallel connection of several motors to an output it is essential to observe the corresponding instructions of the manufacturers, and to use a cut-off relay if necessary. The motors may be destroyed.

Use only Venetian blind motors with mechanical or electronic limit switches. Check the limit switches for correct mastering. Observe the specifications of the motor manufacturers. Device can be damaged.

The device may not be opened or operated outside the technical specifications.

This manual is an integral part of the product, and must remain with the end customer.

3 Mounting and electrical connection



DANGER!

Mortal danger of electric shock.
Disconnect the device. Cover up live parts.



CAUTION!

Overloading the device leads to excessive heating.
Damage to the device and the connected cables may result.
Do not exceed the maximum current carrying capacity.

Connecting the device

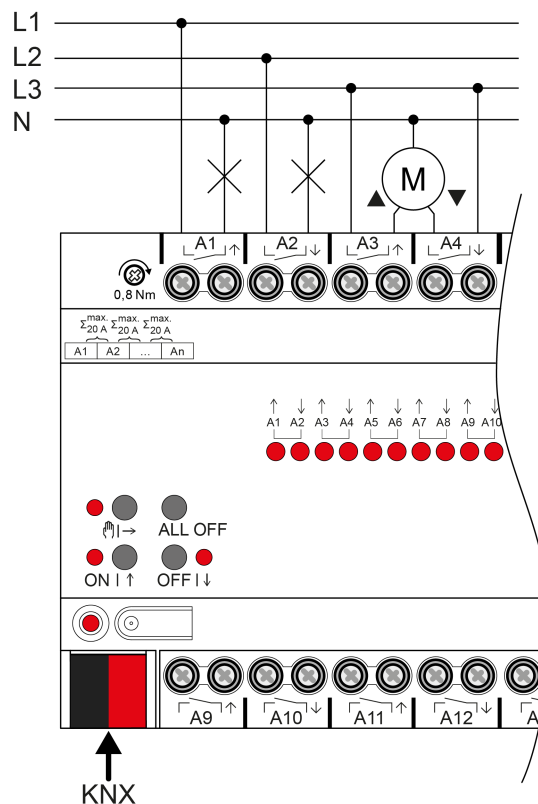

Image 2: Device connection (connection example)

- Connect bus line with KNX device connection terminal observing the correct polarity.
- Attach the cover cap to the KNX connection as protection against hazardous voltages.
- Connect load as shown in the connection example. Two adjacent relay outputs form a Venetian blind output.

- i** Venting louvres and roof windows must be connected to the outputs in such a way that they are opened in travel direction "UP" and closed in travel direction "DOWN".

The total current capacity of neighbouring outputs is a maximum of 20 A.

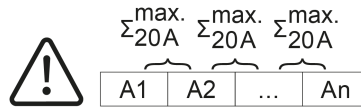

Image 3: Total current capacity of neighbouring outputs

4 Commissioning

Commissioning the device



NOTICE!

Incorrect load control due to undefined relay state at delivery.

Risk of destruction of connected drive motors.

During commissioning, before switching on the load, ensure that all relay contacts are open by applying the KNX bus voltage. Observe commissioning sequence!

- Switch on the KNX bus voltage.
 - Wait about 10 s.
 - Switch on load circuits.
- i** Delivery state: The outputs can be operated with manual control. Outputs are set as Venetian blind outputs.

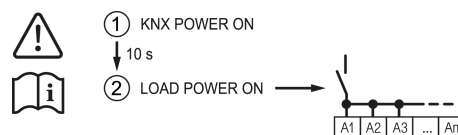

Image 4: Sequence during commissioning

Load physical address and application program

- For switched loads, configure the outputs as a switching output.
- For Venetian blind operation, configure the outputs as a Venetian blind output.
- In Venetian blind operation: measure blind/shutter and slat travel times and enter them in the parameter setting.
- Press the programming button.
The programming LED lights up.
- Load physical address and application program using the ETS.

Safe-state mode

The safe-state mode stops the execution of the loaded application program.

- i** Only the system software of the device is still functional. ETS diagnosis functions and programming of the device are possible. Manual operation is not possible.

Activating safe-state mode

- Switch off the bus voltage or remove the KNX device connection terminal.
- Wait about 15 s.

- Press and hold down the programming button.
- Switch on the bus voltage or attach the KNX device connection terminal. Release the programming button only after the programming LED starts flashing slowly.

The safe-state mode is activated.

By briefly pressing the programming button again, the programming mode can also be switched on and off in the safe-state mode as usual. If the programming mode is active, the programming LED stops flashing.

Deactivating safe-state mode

- Switch off bus voltage (wait approx. 15 s) or carry out ETS programming.

Master reset

The master reset restores the basic device settings (physical address 15.15.255, firmware remains in place). The device must then be recommissioned with the ETS. Manual operation is possible.

In secure operation: A master reset deactivates device security. The device can then be recommissioned with the device certificate.

Performing a master reset

Precondition: The safe-state mode is activated.

- Press and hold down the programming button for > 5 s.

The programming LED flashes quickly.

The device performs a master reset, restarts and is ready for operation again after approx. 5 s.

Restoring the device to factory settings

Devices can be reset to factory settings with the Gira ETS Service App. This function uses the firmware contained in the device that was active at the time of delivery (delivered state). Restoring the factory settings causes the devices to lose their physical address and configuration.

5 Application programs

The expansion of the range of functions has resulted in significant changes to the communication objects and parameter structure in Version 2.5 of the application. This means that the parameters and the assigned group addresses cannot be retained when an older application in an existing ETS project is changed to the current version.

This documentation describes the application from Version V2.5 onwards. A corresponding older version of the documentation is available for use of an older application.

ETS search paths:	- Output / Binary output mix / Switching actuator, 6-gang/ blind actuator, 3-gang Standard
	- Output / Binary output mix / Switching actuator, 16-gang/ blind actuator, 8-gang Standard
	- Output / Binary output mix / Switching actuator, 24-gang/ blind actuator, 12-gang Standard
Name	Switching, Venetian blind 20DA25 Switching, Venetian blind 20DB25 Switching, Venetian blind 20DC25
Version	2.5 for ETS5 from Version 5.7.3 onwards and ETS6
Mask version	SystemB (07B0)
Summarized description	Multifunctional switching/Venetian blind applications with logic functions and manual control for Standard devices. KNX Data Secure capable. Replaces application programs 2.1 and 2.2.

6 Scope of functions

General

- Venetian blind or switching operation parameterizable. In Venetian blind operation, the adjacent outputs (A1/A2, A3/A4...) are combined into single Venetian blind outputs. Mixed operation on an actuator (for example A1 & A2 Venetian blind, A3 & A4 Venetian blind, A5 switching, A6 switching) is possible.
- Actively transmitting feedback or status messages can be delayed globally after bus voltage return or after ETS programming.
- Manual operation of outputs independent of the KNX (for instance, construction site mode) with LED status indicators.
- In construction site mode, the operating mode of the channels can be switched individually between Venetian blind and switching operation.

Venetian blind outputs

- Operating mode configurable: control of blinds with slats, shutters, awnings, roof windows or venting louvres.
- Separately configurable blind/shutter travel times with travel time extension for movements to the upper end position.
- For slatted Venetian blinds, a slat travel time can be configured independently.
- Travel direction change-over time and the times for short-time and long-time operation (step, move) presettable.
- Reaction in case of bus voltage return and after an ETS programming operation is permanently set to "stop".
- Blind/shutter or slat position feedback telegram. In addition, an invalid blind position or an invalid travel movement can be reported back.
- Assigning of outputs to up to 5 different safety functions (3 wind alarms, 1 rain alarm, 1 frost alarm) optionally with cyclical monitoring. The safety functions (objects, cycle times, priority) are programmed device-oriented and in common for all outputs. The assignment of individual outputs to the safety functions and the safety measures can be configured for each channel.
- An sun protection function with fixed and variable blind or slat positions at the beginning and at the end of the function can be activated separately for each output. Dynamic slat offset for slatted blinds included.
- Disabling function can be implemented for each Venetian blind output.
- Up to 16 internal scenes configurable per output.
- Feedback of the end positions.
- Feedback of the combined function status with a standardised and an extended communication object.

Switching outputs

- Independent switching of the switching outputs.
- Operation as NO or NC contacts.
- Switching feedback mode: after changes or cyclically to the bus.
- Reaction on bus voltage return can be set for each output.
- Logic function individual for each output.
- Disabling function can be parameterized for each channel.
- Timing functions (switch-on delay, switch-off delay, staircase lighting timer, also with pre-warning function).
- Incorporation into light moods: up to 16 internal scenes parameterizable per output.
- Feedback of the combined function status with a standardised and an extended communication object.

7 Notes on software

Unloading the application program

The application program can be unloaded with the ETS. In this case the device is without function. Manual operation is no longer possible.

ETS project design and commissioning

For project design and commissioning of the device, ETS5 from Version 5.7.3 onwards or ETS6 is required. Project designing and commissioning of the device using ETS2, ETS3 or ET4 is not possible.

8 Operation and indication

8.1 Button operation and indication functions

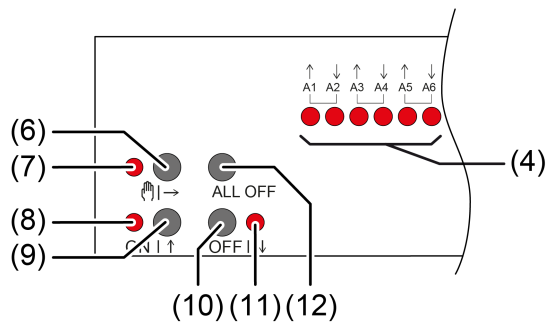

Image 5: Operating elements

- (4) Status LEDs for outputs
 ON: Relay output closed
 OFF: Relay output opened
 Flashes slowly: Output in manual mode selected
 Flashes quickly: Output disabled via continuous manual mode
- (6) Button →
 Manual operation
- (7) LED →
 ON: Continuous manual mode active/Flashing: Temporary manual mode active
- (8) LED **ON** ↑
 ON: Relay outputs closed, manual mode active
- (9) Button **ON** ↑
 Short: Switch on, drive stop
 Long: Move blind/shutter upwards
- (10) Button **OFF** ↓
 Short: Switch off, drive stop
 Long: Move blind/shutter downwards
- (11) LED **OFF** ↓
 ON: Relay outputs opened, manual mode active
- (12) Button **ALL OFF**
 Open all relay outputs, stop drives

In operation with the button field the device distinguishes between a short and a long press.

- Short: Pressing for less than 1 s
- Long: Pressing for between 1 and 5 s

i In switching operation, the device distinguishes between the "NO contact" and "NC contact" operating modes. The buttons (9 + 10) switch the switching state when actuated:

NO contact: Switch on = close relay, Switch off = open relay
 NC contact: Switch on = open relay, Switch off = close relay
 The LED (4 + 8 + 11) always indicate the relay state.

- i** The LEDs (4) optionally indicate the states of the outputs only temporarily (parameter-dependent).

Operating modes

- Bus operation: operation via push-button sensors or other bus devices
- Temporary manual control: manual control locally with keypad, automatic return to bus control
- Continuous manual mode: Exclusively manual operation on the device

- i** No bus operation is possible in manual mode.

- i** After a bus failure and restoration the device switches to bus operation.

- i** The manual mode can be disabled in ongoing operation via a bus telegram.

Switching on temporary manual operation mode

Operation is not disabled.

- Press button \rightarrow (6) briefly.

LED \rightarrow (7) flashes, LEDs A1... (4) of the first configured output or output pair flash.

Short-time manual operation is switched on.

- i** After 5 s without a button actuation, the actuator returns automatically to bus operation.

Switching off temporary manual operation mode

The device is in short-term manual mode.

- No button-press for 5 s.

- or -

- Press \rightarrow (6) button briefly as many time as necessary until the actuator leaves the short-time manual mode.

Status LEDs A1... (4) no longer flash, but rather indicate the relay status.

Short-time manual operation is switched off.

Switching outputs: depending on the programming, the output relays switch to the position that is active after the manual mode is switched off, e.g. logic function.

Blind/shutter outputs: depending on the programming, the hangings move to the position that is active after the manual mode is switched off, e.g. to safety or sun protection position.

Switching on permanent manual operation mode

Operation is not disabled.

- Press the **MAN|→** (6) button for at least 5 s.
LED **MAN|→** (7) lights up, LEDs **A1... (4)** of the first configured output or output pair flash.

Continuous manual mode is switched on.

Switching off permanent manual operation mode

The device is in continuous manual mode.

- Press the **MAN|→** (6) button for at least 5 s.
LED **MAN|→** (7) is off.

Continuous manual mode is switched off. Bus operation is switched on.

Switching outputs: depending on the programming, the output relays switch to the position that is active after the manual mode is switched off, e.g. logic function.

Blind/shutter outputs: depending on the programming, the hangings move to the position that is active after the manual mode is switched off, e.g. to safety or sun protection position.

Operating an output in manual mode

- Activate short-term or permanent manual operation.
- Press button **MAN|→** (6) repeatedly until LED **A1... (4)** of the desired output or output pair flashes.
- Press button **ON|↑** (9) or **OFF|↓** (10).
Short: Switch on/off, drive stop.
Long: Move blind/shutter upwards/downwards.
LED **ON|↑** (8) ON: Relay output closed
LED **OFF|↓** (7) OFF: Relay output opened

i Short-term manual mode: After running through all of the outputs the device exits manual mode after another brief actuation.

Switching off all outputs / Stopping all hangings

The device is in permanent manual operation mode.



- Press the **ALL OFF** button (12).

Switching outputs: all outputs switch off (NO operating mode: relay output opened/NC operating mode: relay output closed).

Venetian blind outputs: all blinds/shutters stop.

Disabling outputs

The device is in continuous manual mode. The bus control can be disabled (ETS parameter).



- Press button  (6) repeatedly until LED **A1...** (4) of the desired output or output pair flashes.
- Press the **ON**  (9) and **OFF**  (10) buttons simultaneously for approx. 5 s. Selected output is disabled.

The status LED **A1...** (4) of the selected output or output pair flashes quickly.

 A disabled output can be operated in manual mode.

Re-enabling outputs





The device is in continuous manual mode. One or more outputs were disabled in manual mode.

- Press button  (6) repeatedly until the output to be unlocked or the output pair is selected.
- Press the **ON**  (9) and **OFF**  (10) buttons simultaneously for approx. 5 s. Disabling is deactivated.

The LED **A1...** (4) of the selected output or output pair flashes slowly.





Switching between Venetian blind and switching operation

The device is not in operation.

- Activate permanent manual operation.
- Press button  (6) repeatedly until LED **A1...** (4) of the desired output or output pair flashes.
- Press the  (6) and **ON**  (9) and **OFF**  (10) buttons simultaneously for approx. 5 s.

Switching operation: Both status LEDs **A1...** (4) of the output pair light up.

Venetian blind operation: Both status LEDs **A1...** (4) of the output pair flash alternately.

- Press the **ON**  (9) and **OFF**  (10) buttons simultaneously. Outputs switch between switching operation and Venetian blind operation. Both status LEDs **A1...** (4) indicate the current operating mode.
- Press the  (6) and **ON**  (9) and **OFF**  (10) buttons simultaneously for approx. 5 s.

Operating mode switchover is terminated, permanent manual operation mode is activated.

- Press the  button (6) for approx. 5 s.

Operating mode switchover is terminated, permanent manual operation mode is deactivated.

8.2 ETS configuration

8.2.1 Manual operation

All outputs of the device have electronic manual operation. The button field with 4 function buttons and 3 status LEDs on the front panel of the device can be used for setting the following modes of operation:

- Bus operation: operation via push-button sensors or other bus devices
- Temporary manual operation mode: manual operation locally with button field, automatic return to bus operation
- Permanent manual operation mode: local manual operation with keypad

Manual operation is possible while the device is supplied with power from the bus supply voltage. In the as-delivered state, manual operation is fully enabled. In this un-programmed state, all outputs are set to blinds operation and can be controlled by the manual operation so that fast function checking of the connected loads (e.g. on the construction site) is possible.

After initial commissioning of the actuator via the ETS, manual operation can be enabled or completely disabled.

Disabling manual operation permanently

Manual operation is enabled in the as-delivered state. If the parameter of the same name is deactivated on the "Manual operation" parameter page, no parameters and communication objects for manual operation are available. The outputs can then only be controlled via the bus.

In the case of a temporary status indication, the status LEDs continue to indicate the status of the outputs when the "Manual operation" button is pressed.

Presetting the behaviour at the beginning and at the end of manual operation

Manual operation distinguishes between the temporary and permanent manual operation modes. The behaviour is different depending on these operating modes, especially at the end of manual operation. It should be noted that the operation via the bus, i.e. control of the outputs by direct operation (switching / moving / scenes) or by the disabling function is always disabled when the manual control is active. This means that manual operation has the highest priority.

Behaviour at the beginning of manual operation:

The behaviour at the beginning of manual operation does not differ for temporary and permanent manual operation modes. When manual control is activated, all travel movements that were started beforehand by bus control for the Venetian blind outputs will still be completed unless the travel movement in question is stopped by hand. Switching states of switching outputs will be maintained. Active disabling, safety and sun protection functions can be overridden by manual operation. These functions are reactivated after deactivation of the manual operation mode unless they have been cancelled in the meantime via the KNX. Then the function with the higher priority is always executed.

Behaviour at the end of manual operation:

The behaviour at the end of manual operation is different for temporary and permanent manual operation modes. The temporary manual operation mode is shut off automatically when the last output has been addressed and when the selection button  is pressed once more. During deactivation of the temporary manual operation mode, the actuator returns to 'normal' bus operation and does not change the states selected by manual control. If, however, a disabling function, a safety function or a sun protection function (independent of priority) has been activated via the KNX before or during manual control, the actuator executes these functions with a higher priority again for the outputs concerned.

The permanent manual operation mode is shut off when the selection button  is pressed for more than 5 seconds. Depending on the parameterization of the actuator in the ETS, the outputs will be set to the state last adjusted in the manual mode or to the state internally tracked (direct operation, disabling, safety or sun protection position) when the permanent manual mode is switched off. The parameter "End of permanent manual control" defines the corresponding reaction.

- Set the parameter "End of permanent manual control" to "no change".

All telegrams received during an active permanent manual control mode for direct operation (switching, long-time/short-time, positioning, scenes) are rejected. After the end of permanent manual operation, the current state of all outputs remains unchanged. If, however, a disabling function, a safety function or a sun protection function (independent of priority) has been activated via the KNX before or during manual control, the actuator executes these functions with a higher priority again for the outputs concerned.

- Set the parameter "End of permanent manual control" to "track outputs".

During an active permanent manual control, all incoming telegrams (blinds operation exception: short-time telegrams – step/stop) are internally tracked. At the end of the manual operation, the outputs will be set to the tracked states or to the positions last set before the permanent manual operation for Venetian blind outputs. The individual priorities of the functions with respect to one another are taken into account here. Only the function with the greater priority is executed. Long time operation is not tracked in Venetian blind operation if the corresponding Venetian blind output is already in the appropriate end position.

i The operations triggered during manual operation update the states of the feedback and status objects. Telegrams are also transmitted to the KNX, if the signal objects concerned are enabled in the ETS and are configured as actively transmitting.

i During an ETS programming operation, an activated manual operation mode will always be terminated. In this case, the parameterised or predefined behaviour at the end of manual operation will not be executed. The actuator executes the configured behaviour after ETS programming instead.

Setting disabling of the bus control

Individual switching or Venetian blind outputs can be disabled locally by manual operation on the device, so that the connected loads can no longer be activated via the KNX telegram. Such disabling of the bus operation is initiated by operation in permanent manual operation mode and is indicated by rapid flashing of the status LEDs on the front panel of the device. The disabled outputs can then only be activated in permanent manual operation.

Manual operation must be enabled.

- Activate the parameter "Disable bus control of individual outputs" on the parameter page "Manual operation".

The function for disabling the bus control is enabled and can be activated locally. Alternatively, deactivating the parameter prevents disabling of the bus control from being activated in permanent manual operation mode.

- i** The disabling initiated locally has the highest priority. Thus all other functions of the actuator that can be activated via the KNX (e.g. disabling or safety function) are overridden. The bus-disabled output remains in the state last set in permanent manual operation mode.

Depending on the parameterization of the actuator in the ETS, the outputs will be set to the state last adjusted in the manual mode or to the state internally tracked (direct operation, disabling, safety or sun protection position) when the permanent manual mode is reactivated and subsequently shut off.

- i** A failure of the bus voltage or an ETS programming operation deactivates disabling of the bus control.

8.2.2 Status indication

The status LEDs on the front of the device can indicate the current status of the switching and Venetian blind outputs permanently or temporarily.

- Continuous status indication:
The parameter "Indicate status temporarily" on the "Status indication" parameter page is deactivated. In the case of a continuous status indication, the status LEDs always indicate the current status of the outputs.
- Temporary status indication:
The parameter "Indicate status temporarily" on the "Status indication" parameter page is activated. During temporary indication, the status indication is activated by pressing the "Manual operation" button. The display length is set in the ETS.
If manual operation is enabled in the ETS, pressing the "Manual operation" button also activates the temporary or permanent manual operation mode. The status indication always remains active during manual operation. At the end of manual operation mode, the display length of the temporary status indication is restarted. The status LEDs then go out after the configured time has elapsed.

If manual operation is not enabled in the ETS, all status LEDs only show the status of the outputs when the "Manual operation" button is pressed, depending on the duration of the display.

i In the as-delivered state, the continuous status indication is preset.

If the parameter "Control via object" is activated, the "Temporary status indication" communication object is available in the ETS. This object is bidirectional and can firstly signal the status of the temporary status indication, and secondly, activate the status display. If a temporary status indication has been activated by pressing the "Manual operation" button, the object transmits the value "ON". If the object receives a telegram with the value "OFF" or "ON", the status LEDs indicate the status of the outputs according to the display length. Manual operation is not activated in this case.

By linking the "Temporary status indication" objects of several actuators using a common group address, the indication functions of the status LED can be synchronized with one another. It is thus possible to activate the status indications of all actuators in a control cabinet at the same time if manual operation is triggered on one actuator only - e.g. for service or maintenance purposes.

In addition, the "Temporary status display" object could be controlled, for example, by a magnetic contact connected to the KNX, so that the status indications of all actuators are activated by opening the control cabinet door. If the door is closed, the status indications for energy saving remain switched off.

i During a running display length, the "Temporary status indication" object does not transmit any new telegrams if the "Manual operation" button is pressed again.

8.3 Operation and indication parameters

Manual operation

Manual operation	Checkbox (yes / no)
Manual operation is possible while the device is supplied with power from the bus supply voltage. This parameter defines whether manual operation is to be possible or deactivated permanently.	

End of permanent manual control	No change Output tracking
<p>The behaviour of the actuator at the end of permanent manual operation depends on this parameter. This parameter is only visible if manual operation is enabled.</p> <p>no change: all telegrams received during an active permanent manual control mode for direct operation (switching, long-time/short-time, positioning, scenes) are be rejected. After the end of the permanent manual operation, the current state of all outputs which was most recently active in manual operation remains unchanged. If, however, a disabling function, a safety function or a sun protection function (independent of priority) has been activated via the KNX before or during manual control, the actuator executes these functions with a higher priority again for the outputs concerned.</p> <p>Track outputs: During active permanent manual operation, all incoming telegrams (blinds operation exception: short-time telegrams – step/stop) are internally tracked. At the end of the manual operation, the outputs will be set to the tracked states or to the positions last set before the permanent manual operation for Venetian blind outputs. The individual priorities of the functions with respect to one another are taken into account here. Only the function with the greater priority is executed. Long time operation is not tracked in Venetian blind operation if the corresponding Venetian blind output is already in the appropriate end position.</p> <p>This parameter is only visible if manual operation is enabled.</p>	

Bus control of individual outputs can be disabled	Checkbox (yes / no)
<p>Individual outputs can be disabled locally during permanent manual operation, so that the disabled outputs can no longer be controlled via the KNX. Disabling via manual operation is only permitted if this parameter is activated.</p> <p>This parameter is only visible if manual operation is enabled.</p>	

Status indication

Indicating status temporarily	Checkbox (yes / no)
<p>The status LEDs on the front of the device can indicate the current status of the switching and Venetian blind outputs permanently or temporarily.</p> <p>Parameter deactivated: Continuous status indication. In this case, the status LEDs always indicate the current status of the outputs.</p> <p>Parameter activated: Temporary status indication. In this case, the status indication is activated by pressing the "Manual operation" button. The display length is set in the ETS. If manual operation is enabled in the ETS, pressing the "Manual operation" button also activates the temporary or permanent manual operation mode. The status indication always remains active during manual operation. At the end of manual operation mode, the display length of the temporary status indication is re-started. The status LEDs then go out after the configured time has elapsed.</p>	
Display length (6...255)	6 ... 10 ... 255
<p>This parameter defines the display length if the temporary status indication is activated.</p>	
Control via object	Checkbox (yes / no)
<p>If the parameter "Control via object" is activated, the "Temporary status indication" communication object is available in the ETS. This object is bidirectional and can firstly signal the status of the temporary status indication, and secondly, activate the status display. If a temporary status indication has been activated by pressing the "Manual operation" button, the object transmits the value "ON". If the object receives a telegram with the value "OFF" or "ON", the status LEDs indicate the status of the outputs according to the display length. Manual operation is not activated in this case.</p>	

8.4 Operation and indication object list

Object no.	Function	Name	Type	DPT	Flag
3	Temporary status indication	Manual operation - Input/Output	1-bit	1.017	C, (R), W, T, A
<p>1-bit object to signal and activate the temporary status indication. This object is bidirectional and can firstly signal the status of the temporary status indication, and secondly, activate the status display. If a temporary status indication has been activated by pressing the "Manual operation" button, the object transmits the value "ON". If the object receives a telegram with the value "OFF" or "ON", the status LEDs indicate the status of the outputs according to the display length. Manual operation is not activated in this case.</p> <p>The object is only visible if the temporary status indication is activated</p>					

9 General

Heartbeat

The heartbeat function makes it easy to check whether the application is running error-free in a device. For this purpose, the communication object Heartbeat sends a telegram with the value "1" with a settable cycle time. The heartbeat function is enabled on the "General" parameter page. The time for the cyclical transmission can then be set on the parameter page "General -> Heartbeat".

9.1 Parameters for heartbeat

General - Enabled functions

Heartbeat	Checkbox (yes / no)
If the parameter is activated, the heartbeat functions and thus the "Heartbeat" object are enabled.	

General -> Heartbeat

Cycle time for transmission of the heartbeat	0 ... 23 h 0 ... 2 ... 59 min
This parameter defines the time with which the device sends a telegram with the value "1" when the application is running. To limit the bus load, times shorter than 1 minute are excluded.	

9.2 Object list for heartbeat

Object no.	Function	Name	Type	DPT	Flag
1470	Heartbeat	Actuator - Output	1-bit	1.002	C, R, -, T, A
1-bit object for cyclical signalling of the device function. When the application of the device is running, the communication object transmits the value "1" at the set cycle time.					

10 Channel configuration



CAUTION!

Incorrect control of the load in case of incorrect device configuration in the ETS!

Danger of destruction of the connected blind drives.

Adapt the device configuration (channel definition) in the ETS to the connected load!



CAUTION!

Operating the actuator outside its technical specification (see Technical Data) can cause relay contacts to melt.

Risk of destruction of the connected drive motors from melted relay contacts and resulting simultaneous energising of both travel directions.

Only ever operate the actuator within its technical specification!

Configuring channel definition

The device is used to activate electrical loads of up to two different building devices that are typically used in a residential or office spaces or in a hotel room. The device has up to 24 potential-free relay outputs for this, depending on the variant. Two outputs together form a pair which can be configured in the ETS either for Venetian blind operation (combined outputs for UP and DOWN) or, alternatively, to switching operation (separate outputs).

The pair formation of the relay outputs allows mixed operation of the named operating modes. By combining the functions of the relay outputs, in many cases it is possible to plan and execute electrical installations on a room-specific basis.

A mechanical locking of the travel directions is not implemented since the outputs must be controllable separately in switching operation.

- Set the desired functions for the output pairs in the channel definition on the "General" parameter page.

Venetian blind: The appropriate output pair is configured to Venetian blind operation. Both outputs are combined into one blind channel. Suitable slatted Venetian blinds, shutters, awnings, roof windows or venting louvres can be controlled.

Switching: The appropriate output pair is configured to switching operation. Both outputs are programmed separately as two switching channels.

It is possible to deactivate output pairs by deselecting the parameter "Use" (e.g. as a reserve for future applications). Deactivated output pairs have no parameters or communication objects and cannot be controlled even with manual operation.

- i** The parameter and object configurations of the individual outputs depend on the parameters on the "General" page and are readjusted by the ETS when the channel definition is changed. Consequently, parameter settings or group address assignments to objects can be lost. For this reason, the channel definition should be reset when beginning the parameterization of the actuator.

10.1 Channel configuration parameters

General -> Channel configuration

A ... Use	Checkbox (yes / no)
Relay outputs that are not required can be activated or deactivated.	
A ... Scope of functions	Venetian blind / Switching
The basic function can be defined for each relay output pair. This parameter should be set at the start because all other parameters and assignments of the group addresses to the communication objects are dependent on it.	

11 Venetian blind operation

11.1 Priorities

The actuator in blinds operation distinguishes between different functions that can have an effect on an output. In order to prevent conflicting states, each available function has a certain priority. The function with the higher priority overrides the function with the lower priority.

For blinds operation there are the following priorities...

- 1st priority: manual control (highest priority)
- 2nd priority: disabling function
- 3rd priority: safety function(s)
- 4th priority: twilight function

Priority levels 5 and 6 can be configured in the ETS. The options are then...

- 5th priority: sun protection function
- 6th priority: direct bus operation

or...

- 5th priority: direct bus operation
- 6th priority: sun protection function

or...

- 5th priority: sun protection function and direct bus operation

i Direct bus operation includes: short-time/long-time operation, positioning, scenes, central functions, reset behaviour, fabric stretching, end position correction.

The behaviour of some functions can be configured at the end (e.g. the behaviour at the end of a safety function or the behaviour at the end of the automatic sun protection). These predefined reactions are only executed if the actuator can then immediately switch to direct operation (lowest priority).

If another function with a lower priority (e.g. sun protection) has been activated during a function with a high priority (e.g. safety), the actuator executes the behaviour at the beginning of the function with the next lower priority (e.g. sun protection). The behaviour at the end of the function with the higher priority (e.g. safety) is then not executed!

11.2 General settings

11.2.1 Reset behaviour

Delay after bus voltage return

To reduce telegram traffic on the KNX line after bus voltage activation (bus reset), after connection of the device to the bus line or after programming with the ETS, it is possible to delay all actively transmitted feedback telegrams of the actuator outputs. For this purpose, a channel-independent delay can be specified (parameter "Delay after bus voltage return" on parameter page "Venetian blind outputs (VBO)"). Only after the configured time elapses are feedback telegrams for initialisation transmitted to the KNX.

Which of the telegrams are actually delayed and which are not can be specified for each Venetian blind output and for status function separately.

- i** The delay has no effect on the behaviour of the outputs. Only the bus telegrams for status or feedback are delayed. The outputs can also be activated during the delay after bus voltage return.
- i** A setting of "0" for the delay after bus voltage return deactivates the delaying function altogether. In this case, any messages, if actively transmitted, will be transmitted to the KNX without any delay.

11.2.1.1 Reset behaviour parameters

General -> Venetian blind outputs (VBO)

Delay after bus voltage return	0...59 min 0...17...59 s
To reduce telegram traffic on the KNX line after bus voltage switch-on (bus reset), after connection of the device to the KNX line or after programming with the ETS, it is possible to delay various actively transmitting feedback telegrams of the Venetian blind function. For this purpose, a delay time can be defined here. Only after the configured time elapses are delayed feedback telegrams for initialisation transmitted to the KNX.	

General - Enabled functions

Heartbeat	Checkbox (yes / no)
If the parameter is activated, the heartbeat functions and thus the "Heartbeat" object are enabled.	

General -> Heartbeat

Cycle time for transmission of the heart-beat	0 ... 23 h 0 ... 2 ... 59 min
This parameter defines the time with which the device sends a telegram with the value "1" when the application is running. To limit the bus load, times shorter than 1 minute are excluded.	

11.2.2 Safety functions

The actuator distinguishes up to three different safety functions for each Venetian blind channel. Each safety function has a communication object of its own so that the functions can be activated or deactivated independently of one another.

There are three different wind alarms available. These alarms, for instance, can be used to protect Venetian blinds or awnings from wind and gusts on several building facades. In addition or as an alternative, a rain alarm, for instance, as a protection for awnings, and a frost alarm as a protection against mechanical damage to lowered Venetian blinds in low temperatures can be activated and used. The telegram polarity of the safety objects is fixed: "0" = No alarm / "1" = Alarm.

Usually, weather stations, which record temperature, wind speed and rain via the sensors, control the communication objects of the safety function.

The safety functions are configured in common for all Venetian blind outputs. The different outputs of the actuator can be separately assigned to all or to individual safety functions. Only assigned outputs respond to a change in the state of the safety objects. The reactions at the beginning of an alarm message ("1" telegram) or at the end of an alarm message ("0" telegram) can be parameterized.

Because outputs are also assigned to multiple safety alarms, the priority of incoming alarm signals can be preset for several channels. Thus, the three wind alarms have the same priority with respect to one another (logic OR). The order of priority of the wind alarms with respect to the frost alarm or to the rain alarm can be configured.

The communication objects for the safety alarms can be monitored for the arrival of cyclical telegrams. If there are no telegrams within a settable monitoring time, the actuator activates the safety movement for the output. The safety function is terminated as soon as a new "0" telegram is received.

Different monitoring times can be selected separately in the ETS for the wind alarms, rain alarm and frost alarm. A shared time is configured for the wind alarms. Each wind alarm has its own time control, so that the wind objects are checked separately for telegram updates.

Enabling the safety functions

The safety functions must first be globally enabled before they can be configured and used. After global enabling, the individual safety alarms can be enabled or disabled independently of one another.

- Activate the parameter "Safety functions" on the "General -> General Venetian blind outputs" parameter page.

The safety functions are enabled globally and the other parameters become visible.

- Activate the parameters "Wind alarm 1", "Wind alarm 2", "Wind alarm 3", "Rain alarm" and "Frost alarm" depending on functional requirements.

The necessary safety alarms are now enabled. The safety objects are visible and can be linked with group addresses.

-  An update of the safety objects ("ON" to "ON" or "OFF" to "OFF") shows no reaction.

- i** After failure of the bus voltage or after programming with the ETS, the safety functions are always deactivated.

Presetting the safety priorities

If several safety alarms are assigned to an output, it is important to preset the priority of the incoming safety telegrams. In so doing, an alarm with a higher priority overrides the alarms with the lower priorities. When safety alarm with the higher priority has ended, the safety alarm with the lower priority is executed on condition that it is active.

The safety functions must be enabled on the parameter page "Relay outputs ... -> VBO ... -> Safety".

- Set the parameter "Priority of safety alarms" on the parameter page "Relay outputs ... -> VBO ... -> Safety" to the required order of priority.

Presetting cyclical monitoring

If cyclical telegram monitoring of the safety objects is necessary, the individual monitoring functions must be activated separately. The monitoring functions must be enabled and the monitoring times preset on the parameter page "Relay outputs ... -> VBO ... -> Safety".

The safety functions must be enabled for the Venetian blind output.

- If monitoring of the wind alarms is to be activated, the parameter "Monitoring", which is immediately below the wind alarms must be activated.

The monitoring function for the wind alarm objects is now activated. As soon as the monitoring function is activated, telegrams must be transmitted cyclically to all enabled wind alarm objects. If only one of the wind alarm telegrams is missing within the monitoring period, the wind alarm reaction will be executed for the output concerned.

- Specify the required monitoring time for the wind alarm objects in the "cycle time" parameters.
- If monitoring of the rain alarm is to be activated, the parameter "Monitoring", which is immediately below the rain alarm must be activated.

The monitoring function for the rain alarm object is now activated. As soon as the monitoring function is activated, telegrams must be transmitted cyclically to the rain alarm object.

- Specify the required monitoring time for the rain alarm object in the "cycle time" parameters.
- If monitoring of the frost alarm is to be activated, the parameter "Monitoring", which is immediately below the frost alarm must be activated.

The monitoring function for the frost alarm object is now activated. As soon as the monitoring function is activated, telegrams must be transmitted cyclically to the frost alarm object.

- Specify the required monitoring time for the frost alarm object in the "cycle time" parameters.
- i** The cycle time of the transmitters should be shorter than the monitoring time configured in the actuator in order to ensure that at least one telegram can be received during the monitoring time.

11.2.2.1 Safety functions parameters

General -> Venetian blind outputs (VBO)

Safety functions	Checkbox (yes / no)
When the safety functions of the actuator, which can number up to 5, are used and should thus be configurable, the channel-independent enabling of the function must take place here.	
Priority of safety alarms	wind → rain → frost wind → frost → rain rain → wind → frost rain → frost → wind frost → rain → wind frost → wind → rain
This parameter defines the priority ranking of the individual safety alarms. Interpretation: high → medium → low. The three wind alarms have the same priority with respect to one another. This parameter is only visible when the safety functions are enabled.	
Wind alarm 1	Checkbox (yes / no)
Here, the parameter can be used to enable the first wind alarm and thus to enable the communication object.	
Wind alarm 2	Checkbox (yes / no)
Here, the parameter can be used to enable the second wind alarm and thus to enable the communication object.	
Wind alarm 3	Checkbox (yes / no)
Here, the parameter can be used to enable the third wind alarm and thus to enable the communication object.	
Monitoring	Checkbox (yes / no)
If the enabled wind alarms are to be monitored cyclically for incoming telegrams to the safety objects, the monitoring function must be enabled here. Otherwise, there is no cyclical monitoring of the objects. As soon as the monitoring function is activated here, telegrams must be transmitted cyclically to all enabled wind alarm objects.	
Cycle time	0 ... 23 h 0 ... 25 ... 59 min
The wind alarm monitoring time is configured here. Sets the hours and minutes of the monitoring time.	
Rain alarm	Checkbox (yes / no)
Here, the parameter can be used to enable the rain alarm and thus to enable the communication object.	

Monitoring	Checkbox (yes / no)
<p>If the enabled rain alarm is to be monitored cyclically for incoming telegrams to the safety object, the monitoring function must be enabled here. Otherwise, there is no cyclical monitoring of the object.</p> <p>As soon as the monitoring function is activated, telegrams must be transmitted cyclically to the enabled rain alarm object.</p>	
Cycle time	0 ... 23 h 0 ... 25 ... 59 min
<p>The rain alarm monitoring time is configured here.</p> <p>Sets the hours and minutes of the monitoring time.</p>	
Frost alarm	Checkbox (yes / no)
<p>Here, the parameter can be used to enable the frost alarm and thus to enable the communication object.</p>	
Monitoring	Checkbox (yes / no)
<p>If the enabled frost alarm is to be monitored cyclically for incoming telegrams to the safety object, the monitoring function must be enabled here. Otherwise, there is no cyclical monitoring of the object.</p> <p>As soon as the monitoring function is activated, telegrams must be transmitted cyclically to the enabled frost alarm object.</p>	
Cycle time	0 ... 23 h 0 ... 25 ... 59 min
<p>The frost alarm monitoring time is configured here.</p> <p>Sets the hours and minutes of the monitoring time.</p>	

11.2.2.2 Object list safety functions

Object no.	Function	Name	Type	DPT	Flag
11	Wind alarm 1	Venetian blind - Safety - Input	1-bit	1.005	C, -, W, -, U
1-bit object for activation or deactivation of the wind alarm ("0" = wind alarm deactivated / "1" = wind alarm activated).					
Object no.	Function	Name	Type	DPT	Flag
12	Wind alarm 2	Venetian blind - Safety - Input	1-bit	1.005	C, -, W, -, U
1-bit object for activation or deactivation of the wind alarm ("0" = wind alarm deactivated / "1" = wind alarm activated).					
Object no.	Function	Name	Type	DPT	Flag
13	Wind alarm 3	Venetian blind - Safety - Input	1-bit	1.005	C, -, W, -, U
1-bit object for activation or deactivation of the wind alarm ("0" = wind alarm deactivated / "1" = wind alarm activated).					
Object no.	Function	Name	Type	DPT	Flag
14	Rain alarm	Venetian blind - Safety - Input	1-bit	1.005	C, -, W, -, U
1-bit object for activation or deactivation of the rain alarm ("0" = rain alarm deactivated / "1" = rain alarm activated).					
Object no.	Function	Name	Type	DPT	Flag
15	Frost alarm	Venetian blind - Safety - Input	1-bit	1.005	C, -, W, -, U
1-bit object for activation or deactivation of the frost alarm ("0" = frost alarm deactivated / "1" = frost alarm activated).					

11.2.3 Name of a Venetian blind output

Here, you can optionally assign a name for each Venetian blind output. The name is intended to illustrate the use of the output (e.g. "Venetian blind living room", "shutter bathroom"). The names are only used in the ETS in the text of the parameter pages and communication objects.

11.2.3.1 Parameter name

Relay outputs... -> VBO... - General

Name of Venetian blind output	Free text
The text entered in this parameter is applied to the name of the communication objects and is used to label the Venetian blind output in the ETS parameter window (e.g. "Venetian blind, living room", "Shutter, bathroom"). The text is not programmed in the device.	

11.3 Operating mode

Each Venetian blind output of the actuator can be independently configured for the drive type connected by defining the operating mode. The device permits the controlling of slatted Venetian blinds, shutters and awnings, or as a third alternative, roof windows. Depending on the preset operating mode, the ETS adapts the parameters and communication objects for all functions of an output.

For example, in the "Venetian blind" with slat" operating mode, there are also parameters and objects for slat control. There is no slat control in the "shutter/awning" operating mode, but a fabric stretching function can be configured for awning use. In the "Venting louvre / roof window" operating mode, a distinction is made between the "opening" and "closing" drive movements, instead of an up or down movement for Venetian blinds or shutters.

In this documentation, Venetian blinds, roller shutters or awnings are also designated with the term "blind", if the text does not explicitly refer to a particular function (e.g. slat control).

In all modes it is possible to specify positions.

Presetting the operating mode

The parameter "operating mode" exists separately for each Venetian blind output on the parameter page "Relay outputs... -> VBO... - General".

- Select the required operating mode in the "Operating mode" parameter.

- i** The "Operating mode" parameter has an influence on many channel-oriented parameters and communication objects. When the operating mode is changed in the ETS, the parameters are adapted dynamically so that settings already made or links between group addresses can be reset. For this reason, the required operating mode should be configured at the beginning of the channel-oriented device configuration.
- i** Venting louvres and roof windows must be connected to the outputs in such a way that they are opened in travel direction "UP" and closed in travel direction "DOWN".
- i** An awning travels upwards when it is rolled up.

11.3.1 Operating mode parameters

Relay outputs... -> VBO... - General

Operating mode	Venetian blind with slat Shutter / awning Venting louvre / roof window
<p>The actuator can control various drive systems. This parameter defines which type of curtain is connected to the output.</p> <p>The ETS adapts all of the following parameters (designations, visible/non visible, etc.) dynamically to the respective "operating mode" parameter. For this reason, the "Operating mode" parameter should be adjusted before all other parameters of an output.</p>	

11.4 Reset and initialisation behaviour

Behaviour after ETS programming

The relay behaviour of the output after an ETS programming operation is permanently set to "stop". After programming with the ETS, the actuator switches the relays of the output to the "stop" position. A travel movement, if any, will be interrupted.

- i** After programming with the ETS, the safety functions and the sun protection function are always deactivated.

Behaviour in case of bus voltage failure

In case of bus voltage failure, the actuator always switches the relays of the output to the "stop" position. A travel movement, if any, will be interrupted. The configured behaviour will not be adopted, if a manual control mode is active at the time of bus failure.

- i** When there is a bus voltage failure, the current position data of the outputs is permanently saved internally, so that these position values can be accurately tracked after bus voltage return, should this be configured. The data will not be stored, if the position data is unknown. The following rules apply for the position data to be stored:
The current blind, slat, venting louvre and roof window positions are stored. With Venetian blinds, the height to be stored is always referred to a slat position of 100 % (cf. "Calculating the slat position"). Positions temporarily approached will be stored also for those outputs that are involved in a travel movement at the time of data storage. On account of the fact that position data is stored as integer percentage values (0...100), a minor deviation from the positions reported back later during bus voltage return (number range 0..255) cannot be avoided.

In case of ETS programming, the saved position data is not lost.

- i** In case of bus voltage failure, the slat offsets of the sun protection positions are stored as well.

Behaviour after bus voltage return

After bus voltage return, the actuator switches the relays of the output to the "stop" position. A travel movement, if any, will be interrupted.

- i** The Venetian blind operation is set as the default in the unprogrammed delivery state of the device. In this state, the relays are switched to the "stop" state when the bus voltage is applied in order to initialise the relays. This short switching operation can be perceived acoustically.

11.4.1 Reset and initialisation behaviour parameter

Relay outputs... -> VBO... - General

After ETS programming operation	stop
The behaviour of the actuator after ETS programming is specified as a fixed value, and cannot be adjusted. The actuator switches the relays of the output to the "stop" position. A travel movement, if any, will be interrupted.	
In case of bus voltage failure	stop
The behaviour of the actuator is predefined in case of bus voltage failure. The actuator switches the relays of the output to the "stop" position. A travel movement, if any, will be interrupted.	
After bus voltage return	stop
The behaviour of the actuator after bus voltage return is fixed. The actuator switches the relays of the output to the "stop" position. A travel movement, if any, will be interrupted.	

11.5 Short-time / Long-time operation, travel times

11.5.1 Short-time / Long-time operation

Determining and configuring short-time and long-time operation

The short-time operation (Step) permits adjusting the slat tilting angle of a Venetian blind or the 'slit opening width' of a shutter. In most cases, short-time operation is activated by pressing a Venetian blind pushbutton sensor permitting manual intervention in the blind controller. When the actuator receives a short-time command while the Venetian blind, shutter, awning or louvre is in motion, the travel movement is stopped immediately by the actuator.

A long-time operation (Move) is determined by the travel time of the connected Venetian blind, shutter/awning or louvre and must therefore not be preset separately. The movement time must be measured manually and entered into the ETS parameters. The control of an output by means of a long-time or a short-time telegram is also designated as 'direct operation'.

To ensure that the curtain or the louvre has definitely reached its end position at the end of long time operation, the actuator always prolongs the long time movement by 20% of the configured or learnt movement time. The actuator also takes into account the parameterized travel time extension for all upward travel movements or for all travel movements to the open position, as the drive motors are generally slower due to the weight of the blind/shutter or due to external physical influences (e.g. temperature, wind, etc.). Thus, it is ensured that the upper end position is always reached even in case of uninterrupted long time travel movements.

- i** A long time or a short time operation can be retriggered by a new incoming long time or short time telegram.
- i** A travel movement activated in the manual control mode or by a safety function is always a long-time operation. The "raising" or "lowering" commands configured in the ETS will equally activate the long time operation.

Presetting the short time operation

Short-time operation is configured separately for each output and independent of the travel time of the blind/shutter or venting louvre / roof window. It is possible to specify in the ETS whether the output executes only a "stop" for a travel movement on reception of a short time telegram or whether the output is activated for a specific duration.

- Set the parameter "Short time operation" on the parameter page "Relay outputs... -> VBO... - General -> Times" to "yes".

The actuator activates the output concerned for the time specified under "Duration of short-time operation" when a short-time telegram is received and when the output is not in the process of executing a travel movement. If the output is executing a travel movement at the time of telegram reception, the output will only just stop.

- Set the "Short time operation" parameter to "no (only stop)".

The actuator will only stop the output on reception of a short time telegram, if the output is in the process of executing a travel movement. There will be no reaction, if the output is not executing a movement at the time of telegram reception.

- i** The configured "Duration of short time operation" for a Venetian blind should correspond to approx. $\frac{1}{4}$ of the complete slat travel time and for a shutter to the full travel time needed for opening a shutter.
- i** The short time operation is always executed without a movement time extension.

11.5.2 Setting the travel time

Determining and configuring travel times (manual entry of travel times)

For computing positions and also for executing long time operation, the actuator needs the exact travel time of the connected Venetian blind, shutter/awning or venting louvre / roof window. The movement times must be measured manually and entered into the ETS configuration. It is important to determine the movement time accurately to permit positions to be approached with good precision. Therefore, it is recommended to make several time measurements, then to take the average of the measured values and enter them in the corresponding parameters. The travel time corresponds to the duration of a travel movement from the completely open position (upper end position / awning rolled up) to the completely closed position (lower end position / awning completely unrolled). Not vice-versa! The movement times are to be determined as a function of the different types of drives.

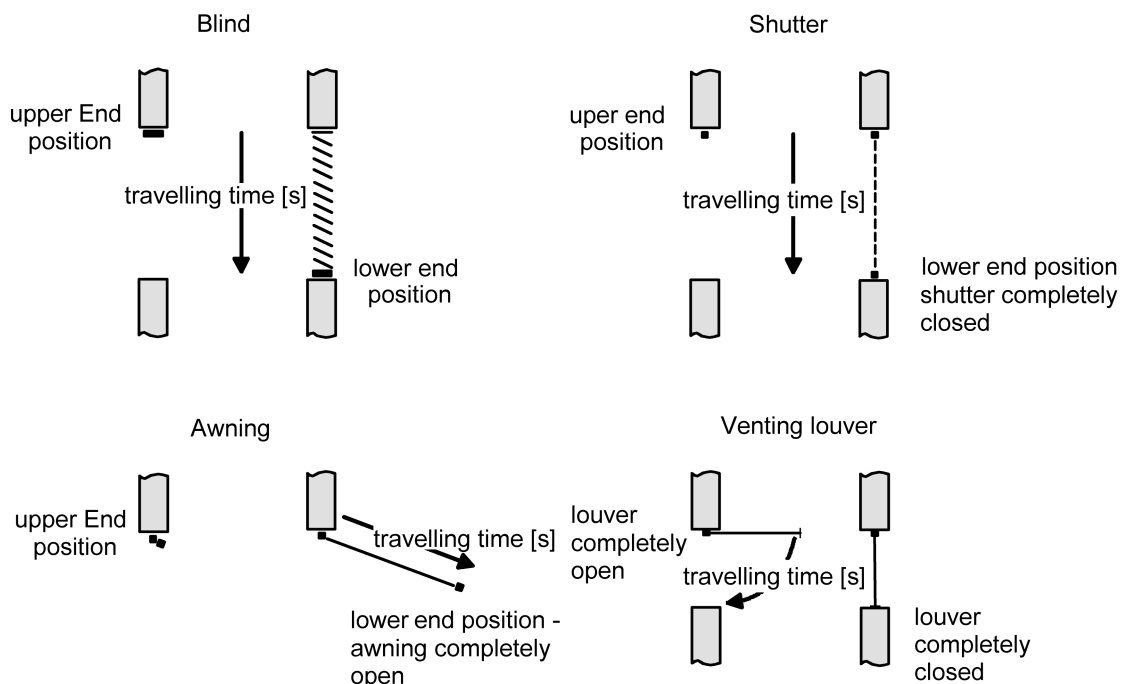

Image 6: Determining the movement time according to the drive type

Setting the travel time of Venetian blinds, shutters/awnings and venting louvres

- Enter the exact travel times determined in the course of the commissioning procedure into the "Venetian blind travel time" or "Shutter/awning travel time" or "Venting louvre / roof window travel time" parameters. The maximum travel time is 19 minutes 59 seconds. The working principle does not allow longer movement times.
- i** The actuator also takes into account the parameterized travel time extension for all upward travel movements or for all travel movements to the open position, as the drive motors are generally slower due to the weight of the blind/shutter or due to external physical influences (e.g. temperature, wind, etc.).

11.5.3 Setting slat travel times (with slatted Venetian blinds)

Determining and configuring the slat travel time (slatted Venetian blinds only)

If Venetian blinds are controlled, the slats can be positioned independently. To enable the actuator to compute slat positions and to report them back to the bus, it is necessary that the actuator gets precise information about the time required for a slat rotation. The slat travel time must in each case be determined manually and entered into the parameters.

The actuator is designed in such a way that it can control single-motor Venetian blind drives without a working position. In this drive mode, the slats are directly adjusted by way of mechanical linkage when the height of the Venetian blind is changed. The actuator assumes that the slats are completely closed when the Venetian blind moves downwards. The actuator assumes that the slats are completely closed when the Venetian blind moves downwards .

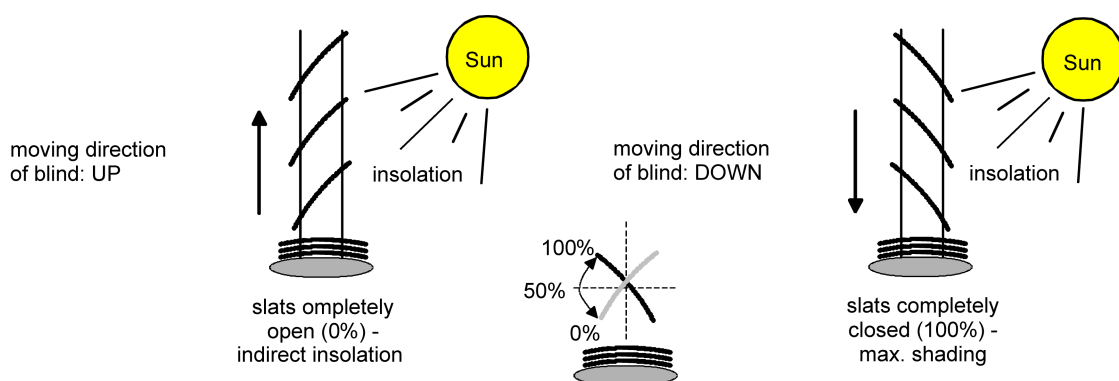

Image 7: Type 1 - Slatted Venetian blinds with oblique slat position in both travel directions

There are also single-motor Venetian blind systems without a working position the slats of which are horizontal during an upward travel and oblique during a downward travel. Such blind types can also be connected to the actuator, in which case a completely open slat position corresponds to the slats in horizontal position.

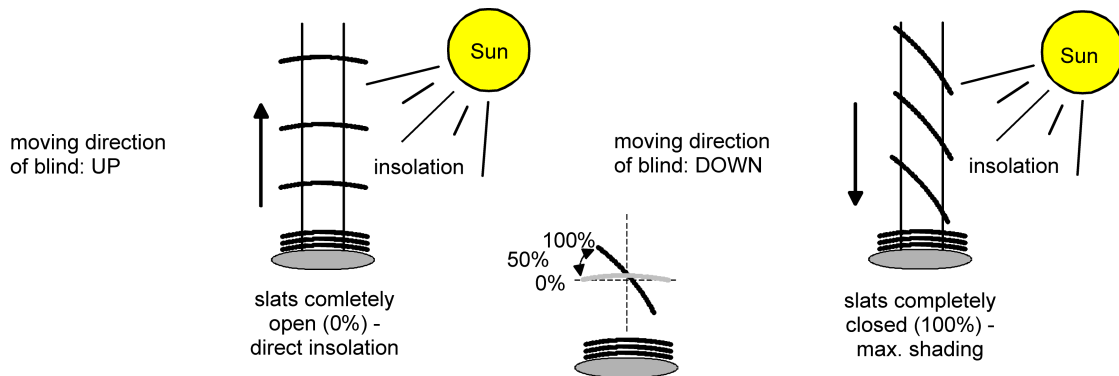

Image 8: Type 2 - Slatted Venetian blinds with oblique and horizontal slat position

Presetting the slat travel time

- Set the parameter "Slat travel time" on the parameter page "Relay outputs... -> VBO... - General -> Times" exactly to the value determined in the course of the commissioning procedure.
- i** The slat travel time must be shorter than the preset or learnt blind/shutter travel time.
- i** The configured travel time extension will also be taken into account when slats are moved into the completely open position (upward movement).

11.5.4 Presetting the travel time extension and switchover time

Presetting the travel time extension

- In the parameter "Travel time extension for upward travel" on the parameter page "relay outputs... -> VBO... - General -> Times" enter the determined travel time extension (by rounding up the determined extension value if necessary).

Presetting the switchover time for travel direction changes

- Set the parameter "Switchover time for travel direction change" on the parameter page "Relay outputs... -> VBO... - General -> Times" to the required switchover interval.
- i** In the as-delivered state of the actuator, the switchover time is generally preset to 1 s.

11.5.5 Short-time / Long-time operation, travel times parameter

Relay outputs -> VBO... - General -> Times

Venetian blind travel time	0...1...19 min 0...59 s
<p>This parameter defines the travel time of the Venetian blind. The time needed for a complete travel from the upper into the lower end position must be determined. This parameter is only visible in the Venetian blind operating mode.</p>	
Shutter/awning travel time	0...1...19 min 0...59 s
<p>This parameter defines the travel time of the shutter or awning. The time needed for a complete travel from the upper into the lower end position must be determined. This parameter is only visible in the shutter/awning operating mode.</p>	
Venting louvre travel time	0...1...19 min 0...59 s
<p>This parameter defines the travel time of the venting louvre. The time needed for a complete travel from the completely open into the completely closed position must be determined. This parameter is visible only in the venting louvre operating mode.</p>	
Slat travel time	0...19 min 0...2...59 s 0...100...900 ms
<p>This parameter defines the travel time of the slats. The time needed for a complete movement from the completely open slat position into the completely closed slat position (travel movement DOWN) must be determined. This parameter is only visible in the Venetian blind operating mode.</p>	
Short-time operation	no (only stop) yes
<p>This parameter can be used to configure the reaction to a received short time telegram.</p> <p>no (only stop): The drive will only be stopped if it is executing a movement at the time of telegram reception. There is no reaction if no movement is in progress.</p> <p>yes: Short-time operation is started on reception of a short-time telegram when the drive is stationary. If the drive is in motion at the time of telegram reception, it will be stopped.</p>	
Time for short time operation	0...59 s 0...10...500...990 ms
<p>This parameter defines the duration of short-time operation. This parameter is only visible, if the parameter "Short-time operation" is set to "yes".</p>	

Switchover time for travel direction change	0.5 s
	1 s
	2 s
	5 s

This parameter specifies the break in a travel direction change (switchover time).

Travel time extension for upward travel	none
	0.5%
	1%
	1.5%
	2%
	3%
	4%
	5%
	6%
	7%
	8%
	9%
	10%
	12.5%
	15%
	20%
30%	

The actuator extends all the up movements or all venting louvre / roof window movements into the opened position using the extension configured here. The time extension expressed in percent is the difference between the measured travel time needed to reach the lower end position (completely closed position) and the time needed to reach the upper end position (completely open position).

11.5.6 Object list Short-time / Long-time operation, travel times

Object no.	Function	Name	Type	DPT	Flag
20, 67 ...	Long-time operation	Venetian blind... - Input	1-bit	1.008	C, -, W, -, U
1-bit object for activation of long time operation.					
Object no.	Function	Name	Type	DPT	Flag
21, 68...	Short-time operation	Venetian blind...- In- put	1-bit	1.007	C, -, W, -, U
1-bit object for activation of short time operation or for stopping a drive movement.					

11.6 Position calculation, position presetting and feedbacks

11.6.1 Position calculation and position presetting

Calculating the curtain height or the venting louvre position

The actuator has a comfortable and accurate positioning function. The actuator calculates the current position of the connected Venetian blind, shutter, awning, venting louvre or roof window whenever these elements are adjusted either by manual or bus control. The calculated position value is a measure of the height of the blind/shutter or of the opening width of the venting louvre / roof window.

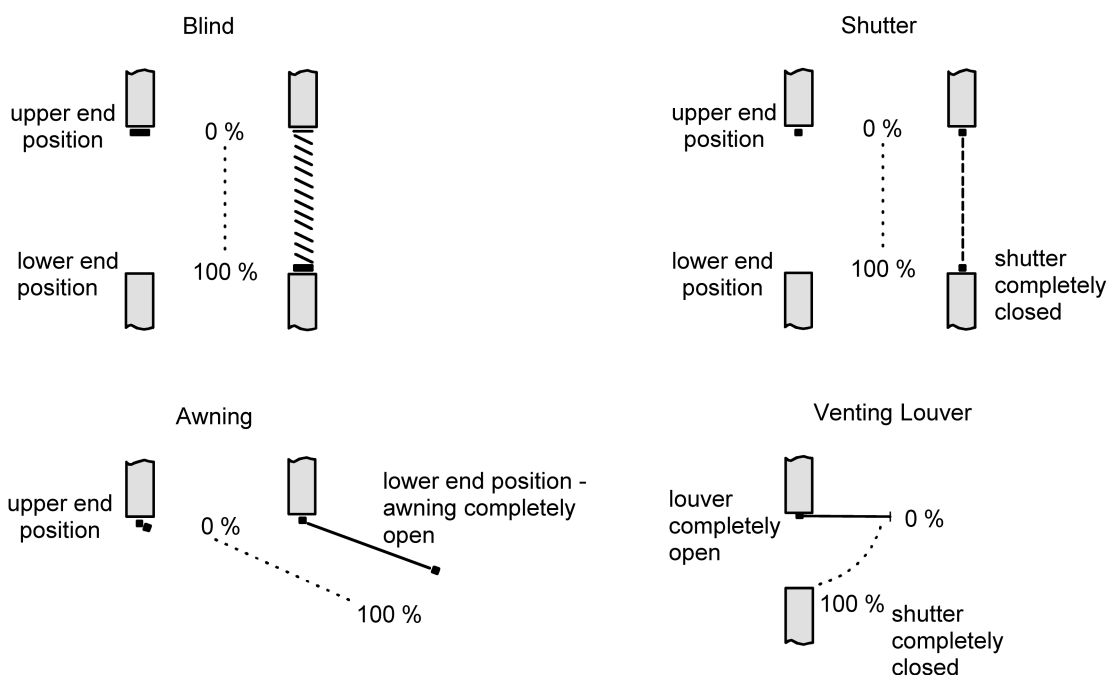

Image 9: Positions defined as a function of the type of movement

The actuator derives the positions from the configured travel time since conventional drives do not provide feedback about their positions. Thus, the travel time configured or learned separately for each Venetian blind output is the reference for all position approaches and of basic importance for the accuracy of the position calculations. For this reason, the travel times should be determined with great accuracy in order to achieve the best possible positioning results.

For positioning purposes, the actuator calculates the movement time required as a function of the current position.

Example 1

The shutter connected to the certain output has an overall travel time of 20 s. The shutter is in its upper end position (0%). It is to be positioned at 25%. The actuator calculates the travel time required for approaching the desired position:
 $20 \text{ s} \cdot 0.25_{(25\%)} = 5 \text{ s}$. The output will then lower the shutter for 5 s and thus position the shutter at height of 25%.

Example 2

The shutter at an output has an overall travel time of 20 s. The shutter is in the 25% position. It is to be positioned at 75%. The difference between the positions is 50%. The actuator calculates the travel time required for bridging the difference between the positions: $20 \text{ s} \cdot 0.5_{(50\%)} = 10 \text{ s}$. The output will then lower the shutter for 10 s and thus position the blind at height of 75%.

With all the upward movements, the configured movement time extension is automatically added to the calculated movement time.

Example 3

The shutter at an output has an overall travel time of 20 s. The shutter is in the 75% position. It is to be positioned at 25%. The difference between the positions is 50%. The actuator calculates the non-extended travel time required for bridging the difference between the positions:
 $20 \text{ s} \cdot 0.5_{(50\%)} = 10 \text{ s}$. Taking the travel time extension into account (e.g. 10%) the actual raising time is: $10 \text{ s} \cdot ((100\% + 10\%_{(\text{travel time extension})}) : 100\%) = 10 \text{ s} \cdot 1.1 = 11 \text{ s}$. The output will then raise the shutter for 11 s and thus position it at a blind height of 25%.

When the lower or upper end positions (0 % or 100 %) are approached, the movement time is always 20 % longer than the overall movement time.

Example 4

The shutter at an output has an overall travel time of 20 s. The shutter is in the 50% position. It is to be positioned at 100%. The difference between the positions is 50%. The actuator calculates the travel time required for bridging the difference between the positions: $20 \text{ s} \cdot 0.5_{(50\%)} = 10 \text{ s}$. As the movement is a limit position movement, the actuator adds 20% of the total travel time:
 $10 \text{ s} + (20\% : 100\%) \cdot 20 \text{ s} = 14 \text{ s}$. The output will then lower the shutter for 14 s and thus position it safely at a blind height of 100%.

Example 5

The shutter at an output has an overall travel time of 20 s. The shutter is in the 50% position. It is to be positioned at 0%. The difference between the positions is 50%. The actuator calculates the non-extended travel time required for bridging the difference between the positions: $20 \text{ s} \cdot 0.5_{(50\%)} = 10 \text{ s}$. As the movement is a limit position movement, the actuator additionally adds 20% of the total travel time:
 $10 \text{ s} + (20\% : 100\%) \cdot 20 \text{ s} = 14 \text{ s}$.
 Taking the travel time extension into account (e.g. 10%) the actual raising time is:
 $14 \text{ s} \cdot ((100\% + 10\%_{(\text{travel time extension})}) : 100\%) = 14 \text{ s} \cdot 1.1 = 15.4 \text{ s}$. The output will then raise the shutter for 15.4 s and thus position safely at 0%.

- i** The actuator executes position approaches only if a new position deviating from the current position is preset.
- i** The actuator stores the blind or venting louvre / roof window positions temporarily. The actuator can approach newly preset positions only if the current positions are known. For this purpose, each output must be given the opportunity

to synchronise itself whenever the bus voltage is switched on or after every ETS programming run (physical address, application program, partial download). This synchronisation is performed by means of a reference movement.

- i** Position approaches in progress will be aborted in case of bus voltage failure. In case of bus voltage failure, the configured behaviour will be executed.

Calculating the slat position (only with blinds)

In the "Venetian blind" operating mode, the actuator always calculates the slat position so that the opening angle and thus the amount of light admitted into the room by the blind can be adjusted. A new position approach by a Venetian blind will always be followed by a positioning movement of the slats. Thus, the slat positions last selected will be tracked or readjusted to a new value if a position change has taken place.

In case of single-motor Venetian blind systems without a working position, the slats will be readjusted directly by a change of the Venetian blind height. For this reason, an adjustment of the slat position will always have an influence on the position of the Venetian blind itself .

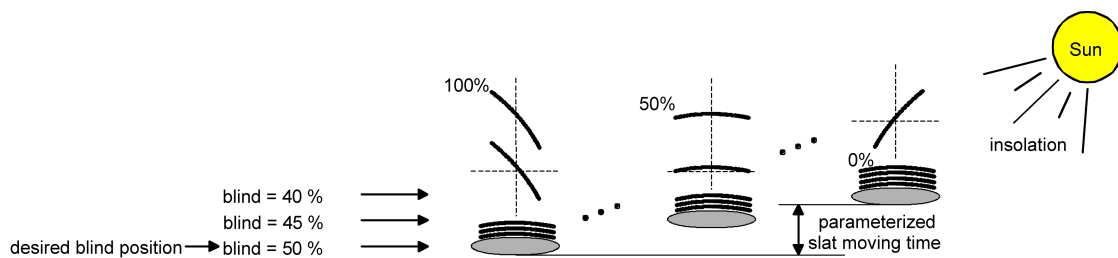

Image 10: Example of slat positioning affecting the position of the Venetian blind (typical of slat type 1; analogous reaction for type 2)

Since a preset slat position is to remain constant until the next change, the actuator will not change the height of the Venetian blind if the calculated movement time required for a change of position lies within the configured slat travel time. Similarly, the actuator accounts for the ratio of the travel times of slat and Venetian blind and – in case of slat position changes – always recalculates the resulting Venetian blind position. If the position feedback objects are used (cf. "Position feedback"), the actuator transmits the blind positions changed by the adaptation also to the bus.

Example (see figure 10)

The Venetian blind position is preset to 50%. A change of the slat angle (100%...0%) initiates the calculation of a new Venetian blind position which is also tracked in the position feedback objects. If the actuator is to approach a new blind position of e.g. 47% in this case, the actuator will not perform a travel movement, as the calculated travel time is within the parameterized slat travel time and thus coincides with the slat movement. A change of the Venetian blind position to 55% in this case triggers a Venetian blind movement as the change does not lie within the slat movement (0 to 100%).

In each position operation, the Venetian blind setpoint position refers to a slat position of 100%. In the event of a slat repositioning movement (0 to 100%), the system will therefore report a Venetian blind position below the desired position.

Exception: The Venetian blind setpoint position of 0% (upper end position) is assigned to the slat position of 0%. The readjustment of the slat position will result also in this case in a change of the Venetian blind height (brief downward movement). Only in this case will the actuator report back a blind position above the desired blind position. With slat type 1, the slats are generally horizontal when the Venetian blind is in its upper end position. For this reason, the calculated slat position with a slat type 1 corresponds to the actual opening angle only after the first slat is completely extended (100%).

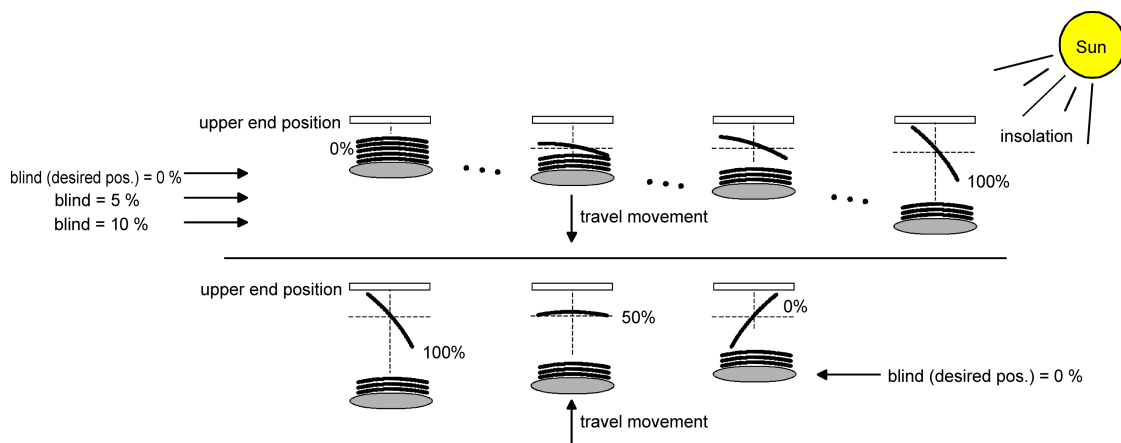

Image 11: Example of slat positioning with the Venetian blind in upper end position (typical of slat type 1.)

Example (see figure 11)

The Venetian blind position is preset to 0%. After an extended movement, the Venetian blind is safely in the upper end position. A change of the slat angle (0%... 100%) initiates the calculation of a new Venetian blind position which is also tracked in the position feedback objects. If the actuator is to approach a new Venetian blind position of e.g. 5% in this case, the actuator will not perform a travel movement, as the calculated travel time is within the parameterized slat travel time and thus coincides with the slat movement. A change of the Venetian blind position to 15% in this case triggers a Venetian blind movement as the change does not lie within the slat movement (0 to 100%).

- i** The actuator executes slat position adjustments only if a new position deviating from the current slat position is preset.
- i** The actuator stores the slat positions temporarily. The actuator can approach newly preset slat positions only if the current position is known. For this purpose, each output must be given the opportunity to synchronise itself whenever the bus voltage is switched on or after every ETS programming run (physical address, application program, partial download). This synchronisation is performed by means of a reference movement for the slat or the Venetian blind.

- i** When positioning the Venetian blind height, the slats are always positioned afterwards. After reactivation of the bus voltage of after ETS programming, the actuator will in this case generally move the slats into the 100% position, if no position has been preset for the slats.
- i** The lower the ratio between slat travel time and Venetian blind travel time, the more precise the positioning and the less marked the influence of the slat angle adjustment on the height of the Venetian blind.

Presetting the position

The following ways of presetting positions can be distinguished...

- Direct positioning via the positioning objects (direct operation),
- Positioning by activating the sun protection function,
- Positioning by a scene recall.

Positioning via the positioning objects:

Each Venetian blind, shutter, awning, venting louvre or each roof window can be positioned directly using the Position ..." object" which is separate for each output. An independent positioning object exists for each of the slats. The position approached is always the position last received. The actuator does not show a reaction when the set or to be approached position value is received several times in succession. Like the operation via short time, long time or scene recall, this form of control is also designated as 'direct operation'. Positioning via the objects therefore has the same priority.

A position approach effected by the communication objects can be interrupted at any time by a short- or long-time or by a scene recall. The direct operation can be overridden by a function with a higher priority, e.g. manual control, safety or also sun protection (configurable).

The position telegrams must correspond to the 1 byte data format according to KNX datapoint type 5.001 (Scaling). The actuator converts the value received (0...255) linearly into a position (0...100%).

Received value (0...255)	Position derived from value (0...100%)
0	0% (upper end position / slat or venting louvre opened)
↓	↓ (all intermediate values rounded off to 1% increments)
255	100% (lower end position / slat or venting louvre closed)

Data format of positioning objects with conversion into percentage position values

It is possible that new positioning telegrams are being received while a position approach is in progress. In this case, the actuator immediately reverses the direction of travel, if the new position to be approached lies in the opposite direction. If a slat positioning command is received during a running Venetian blind position approach, the device finishes first the Venetian blind position approach before positioning the slat. If

a blind positioning command is received during a slat positioning movement, the actuator interrupts the slat positioning movement and approaches the new blind position. Only then does the actuator switch to the most recently received slat position.

In case of Venetian blind positioning, slat positioning will always be executed later. After switching on the bus voltage or after programming with the ETS, it may be the case that the slat position is unknown, if no long time command for the upward or downward movement with a duration of at least the configured slat travel time has been received or no slat positioning has taken place (no slat reference movement). In this case, the slat is moved during a Venetian blind position approach into the completely closed position (100%). The slat position is then considered as calibrated.

- i** Optionally, the sun protection function offers the possibility of receiving the instruction of the blind height, venting louvre / roof window position or slat position to be adopted during sunshine via separate communication objects and to preset these values variably. This form of variable position preset in the sun protection function is identical to presetting the positions via communication objects in direct operation. The priority of the incoming telegrams in direct operation with the sun protection activated can be additionally configured in the ETS.

Positioning by the sun protection function or by a scene recall:

In case of the actuator functions mentioned, the positions to be approached are configured directly in the ETS depending on the operating mode. The position values can be specified between 0% and 100% in 1% increments.

With Venetian blinds, the height of the Venetian blind is positioned first in these cases. The configured slat position is adjusted only thereafter.

- i** Important notes for all positioning movements: Using the connected drives frequently for position approaches (for instance several times a day) can result after some time in positioning inaccuracies. These deviations from the setpoint position are mostly due to external physical influences. To achieve accurate positioning in operation it is recommended to perform the reference movement at least once every day. This can be achieved for instance by a central raising command transmitted to the long time object.

Reference movement

After ETS programming (physical address, application program, partial download) or after bus voltage failure all current position data are unknown. Before the actuator can approach new positions after bus voltage return or after programming, the positioning system must at first be calibrated. A position calibration is possible by executing the reference movement.

A reference movement is the time required for a travel movement into the upper end position increased by 20% and additionally by the configured travel time extension. A reference travel is not retriggerable.

Reference movements can be executed by the following commands...

- uninterrupted long time operation (including also a terminated safety movement) into the upper end position activated via the corresponding communication object,
- an approach of the 0% position,
- a manually controlled movement into the upper end position.

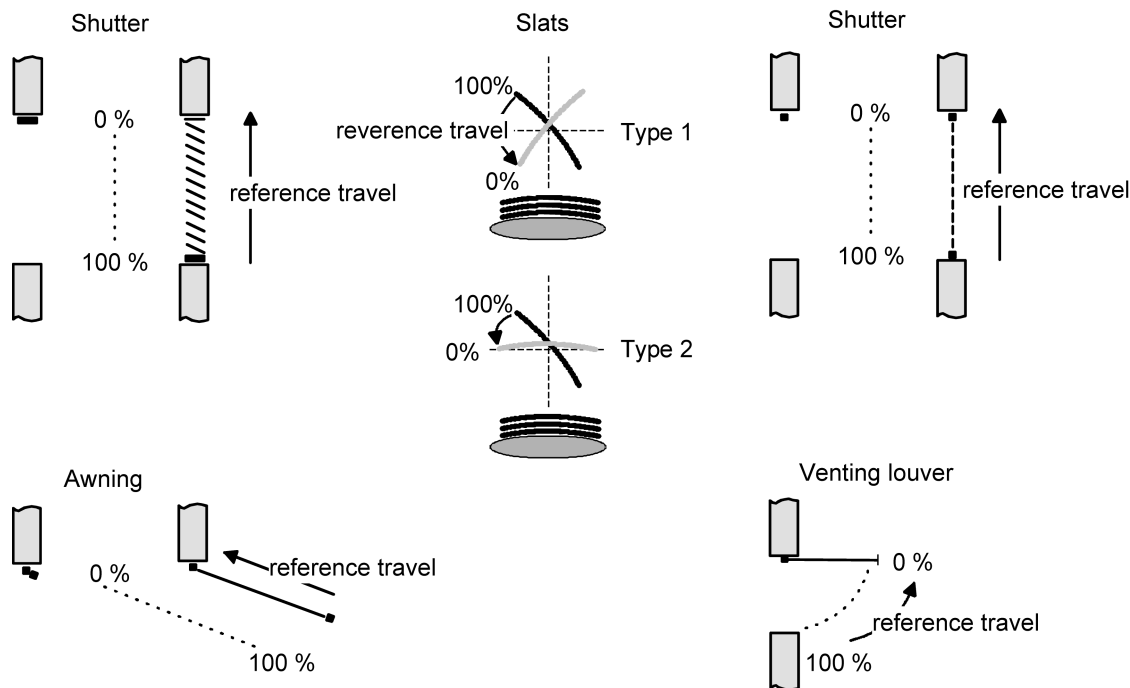

Image 12: Reference movement

In the event of slat positioning via the corresponding communication objects after bus voltage return or after programming, a slat reference movement becomes necessary if the Venetian blind has not been moved beforehand in the up or down directions for at least the configured slat travel time. During a slat reference movement, the actuator always moves first into the completely open position (0%) for the parameterized slat travel time and then moves the slats to the desired position. The slat position is also considered as calibrated when the Venetian blind has been moved by a long-time command in the up or down direction during at least the configured slat travel time.

- i** A terminated reference movement of the Venetian blind will also calibrate the slat position.
- i** If the reference movement is interrupted for instance by a short-time operation, the position is still unknown as before.
- i** A long-time travel into the lower end position activated via the corresponding communication object also calibrates the reference position.
- i** With the sun protection function it is moreover possible to force the actuator to perform a reference movement before each sun protection travel even if the positions are known. Thus, it is ensured that in case of sun protection the configured sun protection position is always precisely approached even after repeated position approaches.

- i** Using the connected drives frequently for position approaches (for instance several times a day) can result after some time in positioning inaccuracies. These deviations from the setpoint position are mostly due to external physical influences. To achieve accurate positioning in operation it is recommended to perform the reference movement at least once every day. This can be achieved for instance by a central raising command transmitted to the long-time object.

11.6.2 Feedback telegrams

Position feedback messages

In addition to presetting positions via positioning objects, the actuator can track the current positions values via separate feedback objects and also transmit them to the KNX, if the bus voltage is on. Thus, the preset setpoint position can be distinguished from the true actual position of the drives activated.

The following feedback telegrams can be preset for each output depending on the parameterised operating mode...

- Feedback (1 byte) of the Venetian blind, shutter, awning or venting louvre / roof window positions,
- Feedback (1 byte) of the slat position (only with Venetian blinds).

The individual position feedback messages can be enabled in the ETS independent of one another and have communication objects of their own. For each travel movement the actuator calculates the current position and tracks it in the position feedback objects. The positions are tracked and the feedback objects updated even when an output has been activated via short-time or long-time telegrams or by manual control on condition that the bus voltage is on.

The feedback objects are updated after the following events...

- at the end of a travel movement – including a slat positioning movement in a Venetian blind – when the drive stops and when the new position is reached,
- with a movement to an end position already at the time the end position is theoretically reached, i.e. before the 20% extension and the travel time extension have elapsed,
- cyclically even during a travel movement, provided that cyclical transmission is active.

The feedback objects are not updated, if the position last reported back has not changed after a movement (for instance, when the Venetian blind is repositioned, the unchanged slat position will not be reported back a second time). The actuator cannot calculate a feedback position, if the current position data after switch-on of the bus voltage or after ETS programming are still unknown. In these cases, the system must first perform a reference movement so that the position can be calibrated. In case of unknown positions, the actuator automatically performs reference travels, if new positions are preset and if these positions are to be approached. As long as a position is unknown, the value of the feedback objects is "0".

Presetting position feedback for Venetian blind, shutter, awning or venting louvre / roof window positions

The feedback functions can be enabled and programmed independently for each output. When feedback is enabled, the ETS adapts the parameter texts depending on the preset operating mode ("Venetian blind position feedback", "Shutter/awning position feedback" or "Venting louvre / roof window position"). The position feedback information is transmitted to the bus whenever a position value changes.

The current position can be transmitted to the KNX after bus voltage return if the position value differs from the one last transmitted. When the position data are known, the feedback telegram can in this case be transmitted with a time delay to reduce the bus load, with the delay being preset globally and in common for all outputs.

The feedback functions of an output must be enabled on the parameter page "Relay outputs... -> VBO... - General -> Enabled functions". Only then are the parameters for the feedback functions visible.

- Activate the checkbox "Status object Venetian blind position", "Status object shutter/awning position" or "Status object venting louvre / roof window position".

The feedback object is enabled. The position value is transmitted as soon as it changes. No value will be actively transmitted, if the position is unknown.

Feedback must be activated.

- If a delay after bus voltage return or after ETS programming should be necessary, activate the parameter "Time delay after bus voltage return".

The position feedback is transmitted with a delay after bus voltage return or after an ETS programming operation, provided that the position is known (reference movement performed). After the end of the delay, the position last adjusted statically will be transmitted to the KNX. No feedback telegram is transmitted during a running delay, even if a position value changes during this delay.

Feedback must be activated.

- If cyclical transmission is required during active movement, activate the parameter of the same name and configure the required cycle time.

The position feedback is transmitted cyclically during a running travel movement. The parameter "Time for cyclical transmission" specifies the cycle time.

i The cyclical transmission only takes place if the position data is known (reference movement completed).

i If, after a bus voltage return or an ETS programming operation, the position data is unknown, the feedback objects are initialised with "0". The object values are then not transmitted to the KNX.

- i** In case of Venetian blind operation, any position change of the Venetian blind within the limits of the slat adjustment (0 to 100%) does not cause a movement and therefore no change of the feedback position data either.

Presetting the position feedback for slat positions (only with Venetian blinds)

The feedback functions for the slat positions can be enabled and programmed independently for each output. The current slat position can be transmitted to the bus after bus voltage return if the position value differs from the one last transmitted. When the position data are known, the feedback telegram can in this case be transmitted with a time delay to reduce the bus load, with the delay being preset globally and in common for all outputs.

The feedback functions of an output must be enabled on the parameter page "Relay outputs... -> VBO... - General -> Enabled functions". Only then are the parameters for the slat position feedback functions visible.

- Activate the checkbox "Status object slat position".
The feedback object is enabled. The position value is transmitted as soon as it changes. No value will be actively transmitted, if the position is unknown.

Feedback must be activated.

- If a delay after bus voltage return or after ETS programming should be necessary, activate the parameter "Time delay after bus voltage return".
The position feedback is transmitted with a delay after bus voltage return or after an ETS programming operation, provided that the position is known (reference movement performed). After the end of the delay, the position last adjusted statically will be transmitted to the KNX. During a running delay the affected feedback object is updated but no feedback is transmitted actively, even if a position value changes during this delay.

Feedback must be activated.

- If cyclical transmission is required during active movement, activate the parameter of the same name and configure the required cycle time.
The position feedback is transmitted cyclically during a running travel movement. The parameter "Time for cyclical transmission" specifies the cycle time.

- i** The cyclical transmission only takes place if the position data is known (reference movement completed). The feedback object of the slat position also transmits cyclically during a blind/shutter movement (e.g. Venetian blind position approach).

- i** If, after a bus voltage return or an ETS programming operation, the position data is unknown, the feedback objects are initialised with "0". The object values are then not transmitted to the KNX.

- i** In case of Venetian blind operation, any position change of the Venetian blind within the limits of the slat adjustment (0 to 100%) does not cause a movement and therefore no change of the feedback position data either.

Individual and combined status feedbacks

In addition to position data feedback, the actuator can also report back enlarged status information messages and transmit them actively to the KNX.

The following status feedback messages can be separately preset for each output...

- Feedback of an invalid position,
- Drive movement feedback,
- Feedback of the end positions,
- Feedback of the combined function status.

Feedback of an invalid position:

After switch-on of the supply voltage or after programming with the ETS, all the position data of an output is unknown. In this case, the actuator can update the feedback object "Invalid position" (object value "ON"), which will then signal that the object values of the 1-byte position feedback objects are invalid.

An invalid position feedback will only be reversed (object value "OFF") after the position data for the Venetian blind, shutter, awning, venting louvre or roof window have been calibrated by means of a reference movement. The calibration of the slat position in a Venetian blind alone will not result in the reversal of an 'invalid position "invalid position".

As an option, the object value of the status feedback message can be actively transmitted to the KNX in case of a value change.

Drive movement feedback:

The actuator can report back via a separate 1-bit communication object per output whether the connected drive is moving, i.e. whether the output is supplying current for any travel direction. The feedback object has the object value "ON", when current is flowing from the output to the drive. Similarly, "OFF" is written into the object if the output concerned remains in a stop position. In this case, the operation by which the output was activated (short-time or long-time operation, positioning, manual control, etc.) is of no importance.

As an option, the object value of the status feedback message can be actively transmitted to the KNX in case of a value change.

The state of the feedback is only derived from the relay state of the actuator. This means that if a drive is blocked or already in its end position, the value reported back does not correspond to the actual state of the travel movement.

Feedback of the end positions:

Depending on the connected drive or blind/shutter type, the actuator may return one or two 1-bit communication objects if the drive has reached an end position. For a Venetian blind, shutter and awning, the upper and lower end positions are signalled separately. In the case of a venting louvre or roof window, only the lower end position is signalled for a closed venting louvre or a closed window. After switch-on of the supply voltage or after programming with the ETS, all the position data of an output is unknown. In this case, the state "End position not reached" (object value "OFF") is sent. The feedback "End position not reached" is not reversed (object value "ON") until the position data for the Venetian blind, shutter, awning, venting louvre or roof window have been calibrated by means of a reference movement and the end position has been reached by means of a correspondingly long movement.

Function status:

Particularly for simple connection to visualisations or for diagnoses, the actuator can also transmit various status information in combined data points. This can significantly reduce the telegram load. Two different types of data points are available. Both communication objects transmit in the case of a change of status.

Setting feedback of an invalid position

The feedback of an invalid position can be enabled and programmed independently for each output. In the case of enabled feedback, the ETS adapts the parameter texts depending on the set operating mode ("Status object invalid Venetian blind position", "Status object invalid shutter / awning position" or "Status object invalid venting louvre / roof window position").

The feedback is transmitted to the KNX whenever an object value changes.

The feedback telegram can be transmitted after bus voltage return with a time delay to reduce the bus load, with the delay being preset globally and in common for all outputs.

The feedback functions of an output must be enabled on the parameter page "Relay outputs... -> VBO... - General -> Enabled functions". Only then are the parameters for the feedback functions visible.

- Activate the checkbox "Status object invalid Venetian blind position", "Status object invalid shutter/awning position" or "Status object invalid venting louvre / roof window position".

The feedback object is enabled. A telegram is transmitted as soon as there is a change (e.g. after ETS programming, after switch-on of the bus voltage or after a reference movement).

Feedback must be activated.

- If a delay after bus voltage return should be necessary, activate the parameter "Time delay for feedback after bus voltage return" on the parameter page "Relay outputs... -> VBO... - General -> Feedback telegrams".

The feedback of an invalid position will be transmitted with a delay after bus voltage return. After the end of the delay, the object value state last adjusted will be transmitted to the KNX. No feedback telegram is transmitted during a running delay, even if a position value becomes known during this delay, for example through a reference movement.

-  Automatic transmission after bus voltage return only takes place if there has been an internal change to the object state (for example through a reference run during manual operation).

Setting drive movement feedback

The feedback of a drive movement can be enabled and programmed independently for each output. The status feedback is transmitted to the KNX whenever an object value changes.

The feedback telegram can be transmitted after bus voltage return with a time delay to reduce the bus load, with the delay being preset globally and in common for all Venetian blind outputs.

The feedback functions of an output must be enabled on the parameter page "Relay outputs... -> VBO... - General -> Enabled functions". Only then are the parameters for the feedback functions visible.

- Activate the checkbox "Status object drive movement".
The feedback object is enabled. A telegram is transmitted when the connected drive starts moving or stops.

Feedback must be activated.

- If a delay after bus voltage return should be necessary, activate the parameter "Time delay for feedback after bus voltage return" on the parameter page "Relay outputs... -> VBO... - General -> Feedback telegrams".

The feedback of a travel movement is transmitted after a delay on bus voltage return, for example, when the drive starts moving on account of the set behaviour after bus voltage return. After the end of the delay, the object value state last adjusted will be transmitted to the KNX. No feedback is transmitted during a running delay, even if the drive stops or starts moving.

-  Automatic transmission only takes place after a bus voltage return when the drive starts moving on bus voltage return or if the bus failure has caused a change to the travel movement.

Setting the feedback of the end positions

The feedback of the end positions can be enabled and programmed independently for each output. In the case of enabled feedback, the ETS adapts the parameter texts depending on the set operating mode ("End positions" or "Status venting louvre / roof window").

The feedback is transmitted to the KNX whenever an object value changes. After bus voltage return, the feedback can be transmitted with a time delay to reduce the bus load, with the delay being preset globally and in common for all outputs.

The feedback functions of an output must be enabled on the parameter page "Relay outputs... -> VBO... - General -> Enabled functions". Only then are the parameters for the feedback functions visible.

- Activate the checkbox "End positions" or "Status venting louvre / roof window".
The feedback object is enabled. A telegram is transmitted as soon as there is a change (e.g. after ETS programming, after switch-on of the bus voltage or after a reference movement).
- If a delay after bus voltage return should be necessary, activate the parameter "Time delay for feedback after bus voltage return" on the parameter page "Relay outputs... -> VBO... - General -> Feedback telegrams".

The feedback of the end positions will be transmitted with a delay after bus voltage return. After the end of the delay, the object value state last adjusted will be transmitted to the KNX. No feedback is transmitted during a running delay.

- If regular signalling of the end positions is required, activate the checkbox "Cyclical transmission".

The end position signal is transmitted cyclically during a running travel movement. The parameter "Time for cyclical transmission" specifies the cycle time.

Setting feedback of the combined function status

The feedback of the combined function status can be enabled and programmed independently for each output.

The feedback functions of an output must be enabled on the parameter page "Relay outputs... -> VBO... - General -> Enabled functions". Only then are the parameters for the feedback functions visible.

- Activate the checkbox "Function status (KNX standard)".

The standardised feedback object is enabled. In addition to the current positions of the blind/shutter and the slats, it contains various bit-coded status information. A telegram is transmitted as soon as there is a change.

The feedback functions of an output must be enabled on the parameter page "Relay outputs... -> VBO... - General -> Enabled functions". Only then are the parameters for the feedback functions visible.

- Activate the checkbox "Function status (KNX extended)".

The feedback object is enabled. It contains various bit-coded status information and an enumeration of the various statuses with higher priorities. A telegram is transmitted as soon as there is a change.

11.6.3 Parameter position calculation, position presetting and feedbacks

Relay outputs... -> VBO... - General -> Enabled functions

Status	Checkbox (active /inactive)
This parameter can be used to enable the feedback functions of the Venetian blind output.	

Relay outputs... -> VBO... - General -> Status

Status object Venetian blind position	Checkbox (active /inactive)
The current Venetian blind position of the output can be reported separately back to the KNX.	
active: Feedback and the object are activated. The object transmits the current status after each adjustment.	
inactive: There is no feedback object available for the output. feedback deactivated	
This parameter is only visible in the "Venetian blind" operating mode.	

Status object shutter/awning position	Checkbox (active /inactive)
The current roller shutter or awning position of the output can be reported separately back to the KNX.	
active: Feedback and the object are activated. The object transmits the current status after each adjustment.	
inactive: There is no feedback object available for the output. feedback deactivated	
This parameter is only visible in the shutter/awning operating mode.	

Status object venting louvre / roof window position	Checkbox (active /inactive)
The current venting louvre / roof window positions of the output can be reported separately back to the KNX.	
active: Feedback and the object are activated. The object transmits the current status after each adjustment.	
inactive: There is no feedback object available for the output. feedback deactivated	
This parameter is only visible in the "venting louvre / roof window" operating mode.	

Delay after bus voltage return	Checkbox (yes / no)
The feedback telegram can be transmitted to the KNX with a delay after bus voltage return or after programming with the ETS. The delay time is configured under "General -> Venetian blind outputs (VBO)".	
This parameter is only visible in case of an actively transmitting feedback object.	

Cyclical transmission during active movement	Checkbox (yes / no)
<p>If cyclical transmission of the blind/shutter position is required during active movement, this parameter can be activated. The position feedback is then transmitted cyclically during a running travel movement. The cyclical transmission only takes place if the position data is known (reference movement completed). This parameter is only visible in case of an actively transmitting feedback object.</p>	
Time for cyclical transmission Seconds	2...5...59
<p>This parameter specifies the cycle time for the cyclical transmission of the blind/shutter position and is only available if cyclical transmission is activated.</p>	
Status object slat position	Checkbox (active /inactive)
<p>The current slat position of the output can be reported separately back to the KNX. active: Feedback and the object are activated. The object transmits the current status after each adjustment. inactive: There is no feedback object available for the output. feedback deactivated This parameter is only visible in the Venetian blind operating mode.</p>	
Delay after bus voltage return	Checkbox (active/ inactive)
<p>The feedback telegram can be transmitted to the KNX with a delay after bus voltage return or after programming with the ETS. The delay time is configured under "General -> Venetian blind outputs (VBO)". This parameter is only visible in case of an actively transmitting feedback object.</p>	
Cyclical transmission during active movement	Checkbox (active/ inactive)
<p>If cyclical transmission of the slat position is required during active movement, this parameter can be activated. The position feedback is then transmitted cyclically during a running travel movement. The feedback object of the slat position also transmits cyclically during a blind/shutter movement (e.g. Venetian blind position approach). The cyclical transmission only takes place if the position data is known (reference movement completed). This parameter is only visible in case of an actively transmitting feedback object.</p>	
Time for cyclical transmission Seconds	1...59
<p>This parameter specifies the cycle time for the cyclical transmission of the slat position and is only available if cyclical transmission is activated.</p>	

Status object invalid Venetian blind position	Checkbox (active/inactive)
<p>The actuator can report to the KNX that the current blind position is unknown (e.g. after an initialisation, when no reference travel has been executed as yet).</p> <p>active: Feedback and the object are activated. The object transmits the current status after each change of its value.</p> <p>inactive: There is no feedback object available for the output. feedback deactivated</p> <p>This parameter is only visible in the Venetian blind operating mode.</p>	
Status object invalid shutter/awning position	Checkbox (active/inactive)
<p>The actuator can report to the KNX that the current roller shutter/awning position is unknown (e.g. after an initialisation, when no reference travel has been executed as yet).</p> <p>active: Feedback and the object are activated. The object transmits the current status after each change of its value.</p> <p>inactive: There is no feedback object available for the output. feedback deactivated</p> <p>This parameter is only visible in the shutter/awning operating mode.</p>	
Status object invalid venting louvre / roof window position	Checkbox (active/inactive)
<p>The actuator can report to the KNX that the current venting louvre/roof window position is unknown (e.g. after an initialisation, when no reference travel has been executed as yet).</p> <p>active: Feedback and the object are activated. The object transmits the current status after each change of its value.</p> <p>inactive: There is no feedback object available for the output. feedback deactivated</p> <p>This parameter is only visible in the "venting louvre / roof window" operating mode.</p>	
Delay after bus voltage return	Checkbox (active/inactive)
<p>The feedback telegram can be transmitted to the KNX with a delay after bus voltage return or after programming with the ETS. The delay time is configured under "General -> Venetian blind outputs (VBO)".</p> <p>This parameter is only visible in case of an actively transmitting feedback object.</p>	
Status object drive movement	Checkbox (active/inactive)
<p>The actuator can report to the KNX that the connected drive is active, i.e. the output is supplying power to the drive for a travel direction.</p> <p>active: Feedback and the object are activated. The object transmits the current status after each change of its value.</p> <p>inactive: There is no feedback object available for the output. feedback deactivated</p>	

Delay after bus voltage return	Checkbox (active/inactive)
<p>The feedback telegram can be transmitted to the KNX with a delay after bus voltage return or after programming with the ETS. The delay time is configured under "General -> Venetian blind outputs (VBO)".</p> <p>This parameter is only visible in case of an actively transmitting feedback object.</p>	
Status object end positions	Checkbox (active/inactive)
<p>The actuator can report to the KNX that the connected drive is in one of the end positions, depending on the blind/shutter type.</p> <p>active: Feedback and the objects are activated. The objects send the current status after each change of their value.</p> <p>inactive: There is no feedback object available for the output. feedback deactivated</p> <p>The parameter is available for the blind/shutter types Venetian blind and shutter/awning.</p>	
Delay after bus voltage return	Checkbox (active/inactive)
<p>The feedback telegram can be transmitted to the KNX with a delay after bus voltage return or after programming with the ETS. The delay time is configured under "General -> Venetian blind outputs (VBO)".</p>	
Cyclical transmission	Checkbox (active/inactive)
<p>If cyclical transmission of the end position is required during active movement, this parameter can be activated. The position feedback is then transmitted cyclically.</p>	
Time for cyclical transmission	<p>0 ... 59 h</p> <p>0 ... 2 ... 59 min</p> <p>0 ... 59 s</p>
<p>This parameter specifies the cycle time for the cyclical transmission of the slat position and is only available if cyclical transmission is activated.</p>	
Status object venting louvre / roof window	Checkbox (active/inactive)
<p>The actuator can report to the KNX that the connected drive is in the closed end position.</p> <p>active: Feedback and the object are activated. The object transmits the current status after each change of its value.</p> <p>inactive: There is no feedback object available for the output. feedback deactivated</p> <p>The parameter is available for the blind/shutter type venting louvre / roof window.</p>	
Delay after bus voltage return	Checkbox (active/inactive)
<p>The feedback telegram can be transmitted to the KNX with a delay after bus voltage return or after programming with the ETS. The delay time is configured under "General -> Venetian blind outputs (VBO)".</p>	

Cyclical transmission	Checkbox (active/inactive)
<p>If cyclical transmission of the slat position is required during active movement, this parameter can be activated. The position feedback is then transmitted cyclically during a running travel movement. The feedback object of the slat position also transmits cyclically during a blind/shutter movement (e.g. Venetian blind position approach). The cyclical transmission only takes place if the position data is known (reference movement completed).</p>	
Time for cyclical transmission	<p>0 ... 59 h</p> <p>0 ... 2 ... 59 min</p> <p>0 ... 59 s</p>
<p>This parameter specifies the cycle time for the cyclical transmission of the slat position and is only available if cyclical transmission is activated.</p>	
Function state (KNX standard)	Checkbox (active/inactive)
<p>The actuator can report a combined function status on the KNX via a 4-byte communication object with the data point type 241,800 (DPT_StatusSAB). This includes the blind/shutter position and bit-coded status information.</p> <p>active: Feedback and the object are activated. The object transmits actively. A telegram is sent each time an individual status changes.</p> <p>inactive: There is no feedback object available for the output. feedback deactivated</p>	
Function state (extended)	Checkbox (active/inactive)
<p>The actuator can report a combined function status to the KNX via a 3-byte communication object with a non-standardised data point type. This includes bit-coded status information and an enumeration of the possible statuses that can disable direct operation due to a higher priority.</p> <p>active: Feedback and the object are activated. The object transmits actively. A telegram is sent each time an individual status changes.</p> <p>inactive: There is no feedback object available for the output. feedback deactivated</p>	

11.6.4 Object list position calculation, position presetting and feedbacks

Object no.	Function	Name	Type	DPT	Flag
22, 69 - Position	Venetian blind... - Input	1-byte	5.001	C, -, W, -, U
1-byte object for presetting a position value (0...255) for the height of the Venetian blind or shutter or the venting louvre / roof window position in direct operation.					
Object no.	Function	Name	Type	DPT	Flag
23, 70 ...	Slat - Position	Venetian blind... - Input	1-byte	5.001	C, -, W, -, U
1-byte object for presetting a slat position value (0...255) in direct operation.					
Object no.	Function	Name	Type	DPT	Flag
38, 85 - Position - Status	Venetian blind... - Output	1-byte	5.001	C, R, -, T, A
1-byte object for position feedback of the Venetian blind or shutter height or venting louvre / roof window position (0...255).					
Object no.	Function	Name	Type	DPT	Flag
39, 86 ...	Slat - Position - Status	Venetian blind... - Output	1-byte	5.001	C, R, -, T, A
1-byte object for position feedback of the slat position (0...255) if one Venetian blind is controlled.					
Object no.	Function	Name	Type	DPT	Flag
40, 87 ...	Invalid position - Status	Venetian blind... - Output	1-bit	1.002	C, R, -, T, A
1-bit object for reporting back an invalid position of the Venetian blind or roller shutter height or venting louvre position ("0" = position valid / "1" = position invalid).					
Object no.	Function	Name	Type	DPT	Flag
41, 88 ...	Drive movement - Status	Venetian blind... - Output	1-bit	1.002	C, R, -, T, A
1-bit object for feedback of an active travel movement (output energised - UP or DOWN). ("0" = no drive movement / "1" = drive movement).					

Object no.	Function	Name	Type	DPT	Flag
50, 97...	Function state (KNX standard)	Venetian blind... - Output	4-byte	241.800	C, R, -, T, A

The following states are signalled to the KNX using this 4-byte output object:

Byte 3 (bit 31 ... bit 24): Blind/shutter height in percent

Byte 2 (bit 23 ... bit 16): Slat position in percent

Bit 15: Slat position (byte 2) valid

Bit 14: Blind/shutter height (byte 3) valid

Bit 13: Reserved (always "0")

Bit 12: Reserved (always "0")

Bit 11: Reserved (always "0")

Bit 10: Error (always "0", the object "Heartbeat" is used for evaluating the device status)

Bit 9: Output has been overridden by manual operation. The bit remains active as long as the status set by the manual operation is active.

Bit 8: Disabling function is active

Bit 7: Forced position is active

Bit 6: At least one safety function (Wind, Rain, Frost) is active

Bit 5: Positioning of the blind/shutter restricted (always "0")

Bit 4: Positioning of the slats restricted (always "0")

Bit 3: End position reached (drive stationary)

Bit 2: Defined lower position reached (always "0")

Bit 1: Lower end position reached

Bit 0: Upper end position reached

An application-orientated filter of the displayed messages can be performed by appropriate KNX devices or visualisation solutions.

Object no.	Function	Name	Type	DPT	Flag
51, 98...	Function state (extended)	Venetian blind... - Output	3-byte		C, R, -, T, A

The following states are signalled to the KNX using this 3-byte output object:

Bit 23 ... Bit 15: Reserved (always "0")

Bit 14: Night mode active

Bit 13: Validity of the slat position

Bit 12: Validity of the blind/shutter position

Bit 11: Twilight mode active

Bit 10: Sun protection active

Bit 9: Ventilation function active

Bit 8: Drive movement active

Bit 7: Lower end position reached

Bit 6: Upper end position reached

Bit 5: ... Bit 0: Enumeration of various statuses with higher priority (in the case of multiple active statuses, the one with the highest priority is output)

The following statuses (numerical values) are defined for the lower-value 6 bits:

0: No disabling active

1: Permanent manual operation active

2: Forced position active

3: Disabling function without acknowledgement active

4: Disabling function with acknowledgement active

5: Door contact disabling without acknowledgement active

6: Door contact disabling with acknowledgement active

7: Wind alarm active (1, 2 or 3)

8: Rain alarm active

9: Frost alarm active

10: Learn travel time active

11 ... 63: Not used

An application-orientated filter of the displayed messages can be performed by appropriate KNX devices or visualisation solutions.

Object no.	Function	Name	Type	DPT	Flag
52, 99...	End position - Top - Status	Venetian blind... - Output	1-bit	1.002	C, R, -, T, A
53, 100...	End position - Bottom - Status	Venetian blind... - Output	1-bit	1,002	C, R, -, T, A

1-bit objects for feedback of the end positions.

("0" = drive not in the end position / "1" = drive in the end position).

11.7 Safety functions

The actuator can handle up to five different safety functions:

3 x wind alarm, 1 x rain alarm, 1 x frost alarm. Each safety function has a communication object of its own so that the functions can be activated or deactivated independently of one another. The safety functions are programmed and configured in common for all Venetian blind outputs.

The different outputs of the actuator can be separately assigned to all or to individual safety functions. Only assigned outputs respond to a change in the state of the safety objects. The reactions at the beginning of an alarm ("ON" telegram) can be configured for each alarm separately whereas the reaction at the end of an alarm ("OFF" telegram) can be configured in common for all alarms.

An output can be assigned independently to the wind alarms, the rain alarm and the frost alarm. If an output is associated with several alarms, the preset priority decides which of the alarms will prevail and be executed. In so doing, an alarm with a higher priority overrides the alarms with the lower priorities. When safety alarm with the higher priority has ended, the safety alarm with the lower priority is executed on condition that it is active.

The order of priority of the wind alarms with respect to the frost alarm or to the rain alarm can be configured for several channels on the parameter page "General -> Venetian blind outputs (VBO)". The three wind alarms have the same priority with respect to one another (logic OR). The last telegram update to the wind alarm objects decides which of the wind alarms will be executed. The wind alarm is completely deactivated only after all three objects are inactive ("OFF").

An output in the active safety alarm state is locked, i.e. the control of the output concerned via the KNX by direct operation (short-time, long-time telegram, scenes, positioning, central) or by a sun protection function is prevented. Only a disabling function and a manual operation locally on the device itself have a higher priority so that these functions may override a safety interlock. At the end of a disabling function or manual operation, the safety reaction is executed again if an assigned safety alarm is still active.

Assigning safety alarms

The individual safety alarms can be assigned separately for each output. The channels are assigned on the parameter page "Relay outputs... -> VBO... - General -> Safety".

The safety functions must be globally enabled on the "General Venetian blind outputs -> Safety" parameter page before the output assignments are configured.

The safety function of an output must be enabled on the parameter page "Relay outputs... -> VBO... - General -> Enabled functions". Only then are the channel-related parameters for the safety function visible.

- If an assignment to the wind alarms is necessary, activate the parameter "Assignment to wind alarm X" (X = 1...3).

The output is assigned to the specified wind alarms.

- If an assignment to the rain alarm is necessary, activate the parameter "Assignment to rain alarm".
The output is assigned to the rain alarm.
- If an assignment to the frost alarm is necessary, activate the parameter "Assignment to frost alarm".
The output is assigned to the frost alarm.

Presetting the behaviour at the beginning of a safety alarm

The behaviour of an output at the beginning of a safety alarm can be parameterized separately for each alarm (wind alarms in common, rain and frost alarms separately). The alarm behaviour is preset on the parameter page "Relay outputs... -> VBO... - General -> Safety". At the beginning of a safety alarm, the actuator locks the outputs concerned, i.e. control via the KNX by direct operation (short time, long time telegram, scenes, positioning) or by a sun protection function is prevented.

Depending on the selected operating mode, the ETS adapts the designations of the parameter settings ("raising" ↔ "opening" / "lowering" ↔ "closing").

The safety functions must be globally enabled on the parameter page "General -> Venetian blind outputs (VBO)".

The safety function of an output must be enabled on the parameter page "Relay outputs... -> VBO... - General -> Enabled functions". Only then are the channel-related parameters for the safety function visible.

The behaviour in case of a safety alarm can only be adjusted, if the output concerned has been assigned to the corresponding alarm. Since there is no difference between the alarm-dependent configurations, the selection of the parameters is only described below for the wind alarm as an example.

- Set the parameter "For wind alarm" to "no reaction".
At the beginning of the alarm, the output is locked and the relay of the output shows no reaction. Any movements still in progress at this instant will still be completely finished.
- Set the parameter "For wind alarm ..." to "raising" or "opening".
The actuator raises the blind/shutter or opens the venting louvre / roof window at the beginning of the alarm and then locks the output.
- Set the parameter "For wind alarm ..." to "lowering" or "closing".
The actuator lowers the blind/shutter or closes the venting louvre / roof window at the beginning of the alarm and then locks the output.
- Set the parameter "For wind alarm ..." to "stop".
At the beginning of the alarm, the actuator switches the relays of the output to "stop" and locks the output. A travel movement, if any, will be interrupted.

- i** The safety travel time required by an output to move the drive into the end positions is determined by the parameter "Travel time" on the parameter page "Relay outputs... -> VBO... - General -> Times". Like the long-time operation, a safety movement is derived from the movement time. Downward movement: movement time + 20%; Upward movement: movement time + 20% + configured movement time extension. Safety movements are not retriggerable.
- i** Slats of blinds are not repositioned at the end of safety movements to end positions.

Setting the behaviour at the end of all safety alarms

The actuator ends the safety interlock of an output only after all safety alarms assigned to the output have become inactive. Afterwards, the output concerned shows the configured "End of safety". The behaviour is configured on the parameter page "Relay outputs... -> VBO... - General -> Safety" in common for all alarms. Depending on the selected operating mode, the ETS adapts the designations of the parameter settings ("raising" ↔ "opening" / "lowering" ↔ "closing").

The safety functions must be globally enabled on the parameter page "General -> Venetian blind outputs (VBO)".

The safety function of an output must be enabled on the parameter page "Relay outputs... -> VBO... - General -> Enabled functions". Only then are the channel-related parameters for the safety function visible.

- Set the parameter "end of safety" to "no reaction".
At the end of all safety alarms, the output is released and the relay of the output shows no reaction. Any travel movements still in progress at this instant will still be finished.
- Set the parameter "end of safety" to "raising" or "opening".
The actuator enables the output at the end of all safety alarms and raises the blind/shutter or opens the venting louvre / roof window.
- Set the parameter "end of safety" to "lowering" or "closing".
The actuator enables the output at the end of all safety alarms and lowers the blind/shutter or closes the venting louvre / roof window.
- Set the parameter "end of safety" to "stop".
At the end of all safety alarms, the output is released and the actuator switches the relays of the output to "stop". A travel movement, if any, will be interrupted.
- Set the parameter "end of safety" to "tracking the position".
At the end of all safety alarms, the output will be set to the state last adjusted statically before the safety function or to the state tracked and internally stored during the safety function. The position objects, the long-time object and the scene function are tracked.

- i** Parameter setting "tracking the position": The actuator can track absolute positions after safety release (position telegram, scene value) only if the position data are known and if the positions have been predefined. In all other cases, no reaction takes place on release of safety.
Position data can be tracked, if the output was in a defined position before the safety function or if a new position telegram was received via the position objects during the safety interlock. In the latter case, a reference movement will be executed when the safety function is enabled, if the position before or during the safety interlock was unknown.
Known slat positions will also be tracked as described. This is also the case, when the height of the Venetian blind is unknown.
Long time movements (movements without position preset) will, however, always be tracked.
- i** The preset "Behaviour at the "end of safety" will only be executed, if the output passes over to direct operation at the end of all safety alarms. If a sun protection function is activated (independent of the preset priority with respect to direct operation), it will be also executed.

Enabling the safety functions

The safety functions must first be globally enabled before they can be configured and used. After global enabling, the individual safety alarms can be enabled or disabled independently of one another.

- Activate the parameter "Safety functions" on the "General -> General Venetian blind outputs" parameter page.
The safety functions are enabled globally and the other parameters become visible.
 - Activate the parameters "Wind alarm 1", "Wind alarm 2", "Wind alarm 3", "Rain alarm" and "Frost alarm" depending on functional requirements.
The necessary safety alarms are now enabled. The safety objects are visible and can be linked with group addresses.
- i** An update of the safety objects ("ON" to "ON" or "OFF" to "OFF") shows no reaction.
- i** After failure of the bus voltage or after programming with the ETS, the safety functions are always deactivated.

Presetting the safety priorities

If several safety alarms are assigned to an output, it is important to preset the priority of the incoming safety telegrams. In so doing, an alarm with a higher priority overrides the alarms with the lower priorities. When safety alarm with the higher priority has ended, the safety alarm with the lower priority is executed on condition that it is active.

The safety functions must be enabled on the parameter page "Relay outputs ... -> VBO ... -> Safety".

- Set the parameter "Priority of safety alarms" on the parameter page "Relay outputs ... -> VBO ... -> Safety" to the required order of priority.

Presetting cyclical monitoring

If cyclical telegram monitoring of the safety objects is necessary, the individual monitoring functions must be activated separately. The monitoring functions must be enabled and the monitoring times preset on the parameter page "Relay outputs ... -> VBO ... -> Safety".

The safety functions must be enabled for the Venetian blind output.

- If monitoring of the wind alarms is to be activated, the parameter "Monitoring", which is immediately below the wind alarms must be activated.

The monitoring function for the wind alarm objects is now activated. As soon as the monitoring function is activated, telegrams must be transmitted cyclically to all enabled wind alarm objects. If only one of the wind alarm telegrams is missing within the monitoring period, the wind alarm reaction will be executed for the output concerned.

- Specify the required monitoring time for the wind alarm objects in the "cycle time" parameters.

- If monitoring of the rain alarm is to be activated, the parameter "Monitoring", which is immediately below the rain alarm must be activated.

The monitoring function for the rain alarm object is now activated. As soon as the monitoring function is activated, telegrams must be transmitted cyclically to the rain alarm object.

- Specify the required monitoring time for the rain alarm object in the "cycle time" parameters.

- If monitoring of the frost alarm is to be activated, the parameter "Monitoring", which is immediately below the frost alarm must be activated.

The monitoring function for the frost alarm object is now activated. As soon as the monitoring function is activated, telegrams must be transmitted cyclically to the frost alarm object.

- Specify the required monitoring time for the frost alarm object in the "cycle time" parameters.

-  The cycle time of the transmitters should be shorter than the monitoring time configured in the actuator in order to ensure that at least one telegram can be received during the monitoring time.

11.7.1 Safety functions parameters

Relay outputs -> VBO... - General -> Enabled functions

Safety functions	Checkbox (yes / no)
This parameter can be used to enable the Venetian blind output.	

Relay outputs... -> VBO... - General -> Safety

Assignment to wind alarm 1	Checkbox (yes / no)
This parameter defines whether the Venetian blind output responds to the first wind alarm.	

Assignment to wind alarm 2	Checkbox (yes / no)
This parameter defines whether the Venetian blind output responds to the second wind alarm.	

Assignment to wind alarm 3	Checkbox (yes / no)
This parameter defines whether the Venetian blind output responds to the third wind alarm.	

For wind alarm	No reaction raising / opening lowering / closing stop
<p>This parameter defines the behaviour of the output at the beginning of a wind alarm.</p> <p>no reaction: At the beginning of the wind alarm or wind alarms, the output is interlocked and the relay of the output shows no reaction. Any movements in progress at this instant will still be completely finished.</p> <p>raising / opening: The actuator raises the blind/shutter or opens the venting louvre / roof window at the beginning of the wind alarm or wind alarms and then locks the output.</p> <p>lowering / closing: The actuator lowers the blind/shutter or closes the venting louver / roof window at the beginning of the wind alarm or wind alarms and then locks the output.</p> <p>stop: At the beginning of the wind alarm or wind alarms, the actuator switches the relays of the output to the "stop" position and locks the output. A travel movement, if any, will be interrupted.</p> <p>This parameter is only visible if the output has been assigned to at least one wind alarm.</p>	

Assignment to rain alarm	Checkbox (yes / no)
This parameter defines whether the Venetian blind output responds to the rain alarm.	

For rain alarm	No reaction raising / opening lowering / closing stop
This parameter defines the behaviour of the output at the beginning of the rain alarm. no reaction: At the beginning of the rain alarm, the output is locked and the relay of the output shows no reaction. Any movements in progress at this instant will still be completely finished. raising / opening: The actuator raises the blind/shutter or opens the venting louvre / roof window at the beginning of the rain alarm and then locks the output. lowering / closing: The actuator lowers the blind/shutter or closes the venting louvre / roof window at the beginning of the rain alarm and then locks the output. stop: At the beginning of the rain alarm, the actuator switches the relays of the output to the "stop" position and locks the output. A travel movement, if any, will be interrupted. This parameter is only visible, if the output has been assigned to the rain alarm.	

Assignment to frost alarm	Checkbox (yes / no)
This parameter defines whether the Venetian blind output responds to the frost alarm.	

For frost alarm	No reaction raising / opening lowering / closing stop
This parameter defines the behaviour of the output at the beginning of the frost alarm. no reaction: At the beginning of the frost alarm, the output is interlocked and the relay of the output shows no reaction. Any movements in progress at this instant will still be completely finished. raising / opening: The actuator raises the blind/shutter or opens the venting louvre / roof window at the beginning of the frost alarm and then locks the output. lowering / closing: The actuator lowers the blind/shutter or closes the venting louver / roof window at the beginning of the frost alarm and then locks the output. stop: At the beginning of the frost alarm, the actuator switches the relay of the output to the "stop" position and locks the output. A travel movement, if any, will be interrupted. This parameter is only visible, if the output has been assigned to the frost alarm.	

<p>End of safety (wind, rain, frost)</p>	<p>No reaction raising / opening lowering / closing stop tracking the position</p>
<p>This parameter defines the behaviour of the output at the end of all safety functions.</p> <p>no reaction: At the end of the safety functions, the output is enabled and the relay of the output shows no reaction. Any travel movements still in progress at this instant will still be finished.</p> <p>raising / opening: The actuator enables the output at the end of all safety alarms and raises the blind/shutter or opens the venting louvre / roof window.</p> <p>lowering / closing: The actuator enables the output at the end of the safety functions and lowers the blind/shutter or closes the venting louvre / roof window.</p> <p>stop: At the end of the safety functions, the output is enabled and the actuator switches the relays of the output to the "stop" position. A travel movement, if any, will be interrupted.</p> <p>tracking the position: At the end of safety, the output will be set to the state last adjusted before the safety function or to the state tracked and internally stored during the safety function. The position objects, the long-time object and the scene function are tracked.</p> <p>The behaviour preset in this parameter will only be executed, if the output passes over to direct operation at the end of safety. Direct operation will be executed when a sun protection function is active.</p>	

11.7.2 Object list safety functions

Object no.	Function	Name	Type	DPT	Flag
11	Wind alarm 1	Venetian blind - Safety - Input	1-bit	1.005	C, -, W, -, U
1-bit object for activation or deactivation of the wind alarm ("0" = wind alarm deactivated / "1" = wind alarm activated).					
Object no.	Function	Name	Type	DPT	Flag
12	Wind alarm 2	Venetian blind - Safety - Input	1-bit	1.005	C, -, W, -, U
1-bit object for activation or deactivation of the wind alarm ("0" = wind alarm deactivated / "1" = wind alarm activated).					
Object no.	Function	Name	Type	DPT	Flag
13	Wind alarm 3	Venetian blind - Safety - Input	1-bit	1.005	C, -, W, -, U
1-bit object for activation or deactivation of the wind alarm ("0" = wind alarm deactivated / "1" = wind alarm activated).					
Object no.	Function	Name	Type	DPT	Flag
14	Rain alarm	Venetian blind - Safety - Input	1-bit	1.005	C, -, W, -, U
1-bit object for activation or deactivation of the rain alarm ("0" = rain alarm deactivated / "1" = rain alarm activated).					
Object no.	Function	Name	Type	DPT	Flag
15	Frost alarm	Venetian blind - Safety - Input	1-bit	1.005	C, -, W, -, U
1-bit object for activation or deactivation of the frost alarm ("0" = frost alarm deactivated / "1" = frost alarm activated).					

11.8 Sun protection function

Introduction

Each Venetian blind output of the actuator can be separately configured for the execution of a sun protection function. Sun protection is generally realized with blinds, shutters or awnings and offers an intelligent method of shading rooms, terraces or balconies during sunshine depending on the altitude of the sun in the sky and on the intensity of the sunlight.

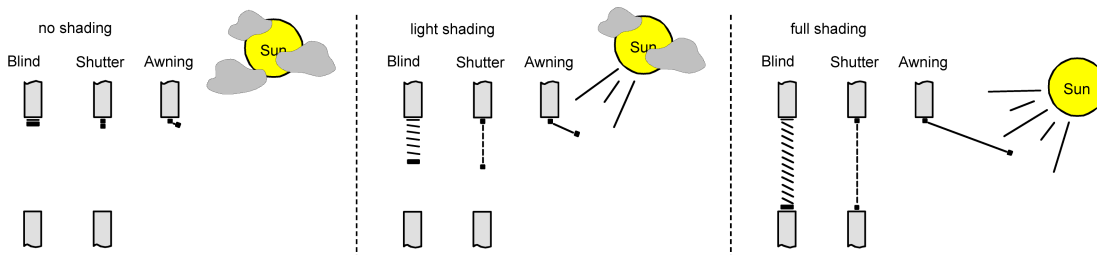

Image 13: Sun protection principles (example)

The sun protection functions of the actuator can be adapted many different applications. In simple applications as, for instance, in case of direction-dependent measurement of the sun's intensity by means of a brightness sensor, the curtains controlled can be closed partly or completely to prevent being disturbed by direct sunlight. In these applications, the sun protection function merely evaluates the 1-bit sun signal from the brightness or a similar sensor (e.g. weather station with limit value monitoring) and makes a drive open or close the controlled curtains by moving them into fixed configured positions or into variable positions preset via the bus.

Already simple sun protection applications are sufficient to permit a fixed or variable re-adjustment of the positions of Venetian blind slats for adapting the curtain to individual shading requirements. For this purpose, it is possible to set a static slat offset in the ETS configuration, for instance, for adapting the reflection of sunlight depending on the building situation, or additionally, via a KNX communication object, e.g. for manual re-adjustment of the slat opening by people in the room or otherwise by a central building services control system.

In all cases, the priority between an incoming sunshine telegram and the direct operation of an output (short-time, long-time telegram, scenes, positioning) can also be preset in the ETS. This way, a sun protection position can, for instance, be influenced by a manual operation of a push-button sensor in the room and the sun protection function be interrupted. Alternatively, sun protection mode can therefore not be interrupted by a direct operation, i.e. the output is locked.

A sun protection function can be overridden by a safety function or also by a manual control locally on the device itself, as these functions of the actuator invariably have a higher priority. At the end of one of the mentioned functions with a higher priority, the same reaction as the one at the beginning of sun protection will be re-executed, if the sun protection function is still active at this time.

Simple sun protection

In simple sun protection, shading against sunlight is activated and deactivated via the 1-bit communication object "Sunshine". The polarity of this object can be selected in the ETS. The sun protection is activated as soon as "sunshine" is signalled to the object depending on the preset polarity. After ETS programming or after switch-on of the supply voltage, the object must at first have data written into it by the KNX also in case of inverted polarity before the sun protection can be activated.

A newly received object value (sunshine beginning or sunshine end) can optionally be evaluated with a time delay. This feature permits suppressing brief brightness variations caused, for instance, by passing clouds or by a thunderstorm. An update (from activated to activated) of the "Object "sunshine" causes the sun protection to be reactivated if it had been influenced and possibly re-enabled beforehand by a direct operation in acc. with the preset priority.

The reaction of a specific output at the beginning of shading can be preset in the ETS. Amongst other things, this setting permits approaching fixed configured positions or positions preset via the KNX and thus variable. Variable positions for sun protection purposes can be preset, for instance, by means of pushbutton sensors or visualisations. In addition, it is possible in case of a defined sun protection positioning movement to have a reference travel executed by forced control. This ensures that identical blind positions are approached synchronously by different outputs in case of a sun protection positioning movement.

The reaction at the end of a shading task can be preset as well. In this situation, the curtain can pass into an end position, be stopped or shown no special reaction. Tracking of positions is possible as well.

A priority setting in the ETS configuration makes it possible to specify whether the sun protection function can be influenced by direct operation or whether the corresponding output is locked by a telegram "Sunshine" in the sun protection position. Generally, the "Manual operation", "Disabling function" and "Safety" functions have a higher priority so that these functions can override, but not terminate, a sun protection function. Thus, the sun protection function is re-executed at the end of a function with a higher priority, if the Object "sunshine" continues to signal the presence of sunshine.

- i** The following rules must be observed for the extended sun protection: After an ETS programming operation, the sun protection function including automatic operation is always deactivated.

The schematic diagram of the simple sun protection and an example of how sensor components can be integrated into a simple sun protection configuration.

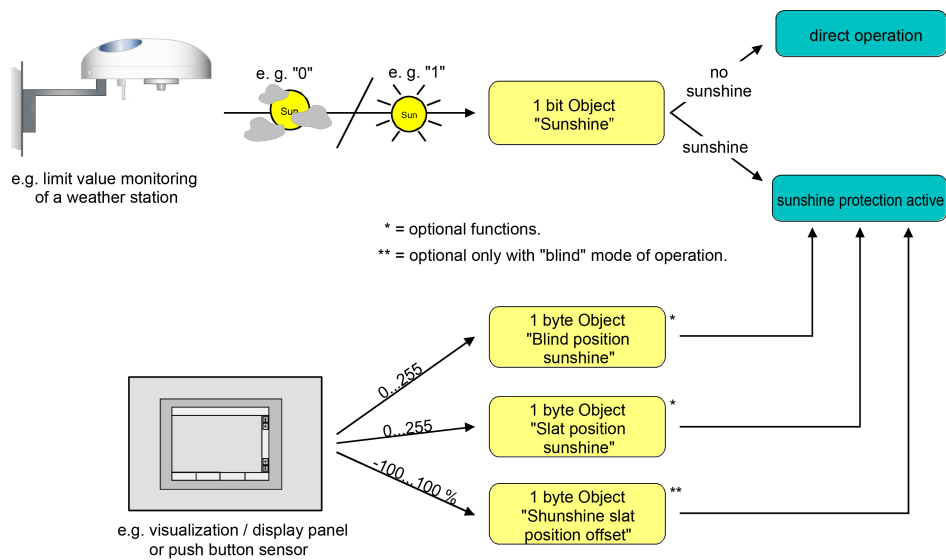

Image 14: Schematic diagram illustrating the simple sun protection configuration

The function diagram shows all possible functions of the simple sun protection. For reasons of clarity, the functions with a higher priority (manual control, safety function) are not shown in the diagram.

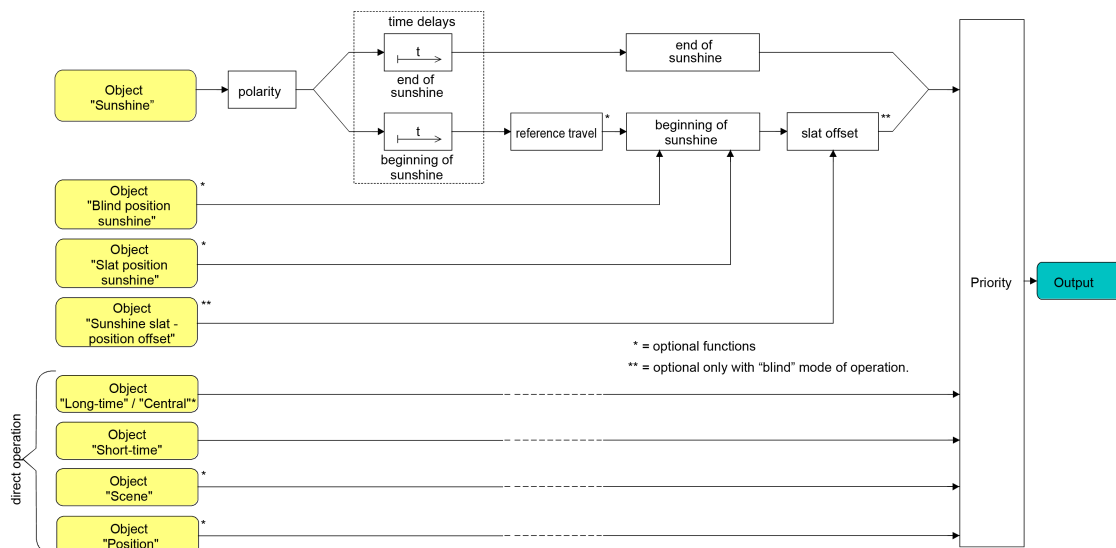

Image 15: Function diagram illustrating the simple sun protection

Presetting the priority of the sun protection

The priority of the sun protection function can be set separately for each Venetian blind output. In the sun protection, the priority between the "Sunshine" object and the objects of direct operation (short-time, long-time or position telegram, scene recall) must be configured.

The sun protection function must be enabled on the parameter page "Relay outputs... -> VBO... - General -> Enabled functions" in order for the sun protection parameters to be visible.

- Set the parameter "Priority of sun protection operation with respect to direct operation" on the parameter page "Relay outputs... -> VBO... General -> Sun protection" to "Same priority".

The sun protection mode can be overridden at any time by direct operation. Similarly, the sun protection overrides the direct operation, when a new "sunshine" telegram is received via the object of the same name and when a configured time delay, if any, has elapsed. If the sun protection function is overridden by a direct operation, the preset behaviour "at the end of sunshine" will not be executed.
 - Set the parameter "Priority of sun protection operation with respect to direct operation" to "Higher priority".

An active sun protection will override a direct operation. The sun protection mode can therefore not be interrupted by a direct operation. Direct operation will be possible again only after the sun protection function is terminated.
 - Set the parameter "Priority of sun protection operation with respect to direct operation" to "Lower priority".

A direct operation can at any time override the sun protection mode. If the sun protection function is overridden by a direct operation the preset behaviour "at the end of sunshine" will not be executed. The sun protection function can only be reactivated after an enabling movement controlled by a direct operation has been effected and after a new "sunshine" telegram has been received via the "sunshine" object. Attempts to activate the sun protection function are ignored for as long as the enabling movement has not taken place.

On the enabling movement:
An enabling movement is an accomplished long-time movement into the upper end position which has been initiated by the object "Long time operation". A manual operation, an upward movement after bus voltage return, a position approach to "0%" or an upward movement after enabling of safety functions have no enabling effect!
The sun protection is not enabled if the enabling movement has been interrupted. The sunshine protection function will be also be disabled if the output has been readjusted again by a direct operation after an accomplished enabling movement.
After an ETS programming operation or switch-on of the supply voltage, the sunshine protection function is always enabled.
- i** Manual local operation on the device itself and the safety functions have a fixed priority higher than that of the sun protection. The sun protection is overridden – but not terminated – by a function with a higher priority. After the end of the function with the higher priority the reaction at the beginning of sun protection will therefore be executed again, if the sun protection is still active at this time.

- i** With the settings "same priority" or "lower priority", the sun protection can be overridden by a direct operation only if the direct control action can be executed at once. A direct operation will therefore not override the sun protection during a manual control locally on the device or an active safety function.
- i** Parameter setting "same priority" or "lower priority": A variable preset of blind/shutter and slat positions or of a slat offset via the KNX at the beginning of sunshine shows no reaction at the output, if the sun protection was overridden by direct operation. However, the position data or offsets received are stored internally so that the new positions will be approached on reactivation of the sun protection.

Presetting the polarity of the "Sunshine" object

The telegram polarity of the "Sunshine" object can be preset separately for each output. This means that an adaptation to the signals from existing sensors or weather stations is possible in the simple and also in the extended sun protection mode.

The sun protection function must be enabled on the parameter page "Relay outputs... -> VBO... - General -> Enabled functions" in order for the sun protection parameters to be visible.

- Set the parameter "Polarity of 'Automatic' object" on the parameter page "Relay outputs... -> VBO... General -> Sun protection" to the required telegram polarity.

The sunshine signal is evaluated in accordance with the preset priority.

- i** In the sun protection an update (from activated to activated) of the "Sunshine" object causes the sun protection to be reactivated if it had been influenced and possibly re-enabled beforehand by a direct operation in acc. with the preset priority.

Presetting a time delay for beginning and end of sunshine

The telegram received via the "sunshine" object for activation or deactivation of shading (depending on polarity) can be evaluated with a time delay separately for each output. The preset delay times are always evaluated in the simple as well as in the extended sun protection mode.

The sun protection function must be enabled on the parameter page "Relay outputs... -> VBO... - General -> Enabled functions" in order for the sun protection parameters to be visible.

- Set the parameter "Delay at the beginning of sunlight" on the parameter page "Relay outputs... -> VBO... General -> Sunshine -> Set Sun protection start" to the required delay time.

The telegram for activation of the sun shading will be evaluated with a delay corresponding to the setting.

- Set the parameter "Delay at the end of sunlight" on the parameter page "Relay outputs... -> VBO... General -> Sunshine -> Set Sun protection end" to the required delay time.

The telegram for deactivation of the sun protection will be evaluated with a delay corresponding to the setting.

- i** A setting of "0" in the parameters deactivates the respective delay time. In this case, the state of the sunshine signal is evaluated immediately.
- i** An update (from activated to activated) of the "Sunshine" object causes the sun protection to be reactivated in consideration of the delay time, if the sun protection had been influenced or aborted beforehand by a direct operation because of the same or a lower priority.

Presetting the reaction at the beginning of sunshine

The behaviour of the output at the beginning of sunshine / shading – if applicable, after the end of the delay time – can be configured in the ETS separately for each output. In the sun protection mode, the behaviour will be executed, when the sun protection function is activated after receiving a new sunshine signal. The reaction will not be executed if a function with a higher priority is active at the time the sun shading is received.

The reaction for the beginning of sunlight is set on the parameter page "Relay outputs... -> VBO... General -> Sunshine -> Sun protection start".

The sun protection function must be enabled on the parameter page "Relay outputs... -> VBO... - General -> Enabled functions" in order for the sun protection parameters to be visible.

- Set the parameter "at the beginning of sunshine" to "no reaction".
At the beginning of shading, the output switches over to sun protection while the relays of the output show no reaction. Any travel movements still in progress at this instant will still be finished.
- Set the parameter "at the beginning of sunshine" to "raising" or "opening".
At the beginning of shading, the actuator raises the blind/shutter or opens the venting louvre / roof window.
- Set the parameter "at the beginning of sunshine" to "lowering" or "closing".
At the beginning of shading, the actuator lowers the blind/shutter or closes the venting louvre / roof window.
- Set the parameter "at the beginning of sunshine" to "stop".
At the beginning of shading, the actuator switches the relays of the output to the "stop" position. A travel movement, if any, will be interrupted.
- Set the parameter "at the beginning of sunshine" to "internal scene recall".
Configure the internal scene to be recalled (parameter "internal scene").
At the beginning of shading, the actuator recalls the position value for the output concerned which was preset in the scene configuration. This is not a scene recall as in direct operation, but only an approach to the corresponding scene position value.
- Set the parameter "at the beginning of sunshine" to "fixed position".

At the beginning of shading, the actuator recalls a fixed position value for the output concerned.

- i** In the "Venetian blind" operating mode, the "fixed position" setting can be selected separately for the height of the blind and for the slat position. For this reason, the ETS adapts the parameter selection and enlarges the setting options in this operating mode.
- "Fixed position" only: Set the parameter "Fixed position of Venetian blind", "Fixed position of roller shutter/awning" or "Fixed position of venting louvre" to "as specified by parameter". Thereafter, set the parameter "Position of Venetian blind (0...100%)", "Position of roller shutter/awning (0...100%)" or "Position of venting louvre (0...100%)" to the desired position.

At the beginning of shading, the output invariably approaches the configured position value.

- "Fixed position" only: Set the parameter "Fixed position of Venetian blind", "Fixed position of roller shutter/awning" or "Fixed position of venting louvre" to "no change of current position".

At the beginning of shading, the last set position of the Venetian blind height, shutter, awning or venting louvre will be maintained.

- "Fixed position" and operating mode = "Venetian blind" only: Set the parameter "Fixed slat position (0...100%)" to the desired position value.

At the beginning of shading, the output invariably moves the slats to the configured position after the height of the Venetian blind has been adjusted.

- Set the parameter "at the beginning of sunshine" to "variable position".

At the beginning of shading, the actuator recalls the variably specified position value for the output concerned. The variable position of the Venetian blind height, of the shutter, awning or venting louvre position is preset via the separate communication object "sun protection - ...position" (in the "Venetian blind" operating mode for the slats as well as via the separate object "sun protection - slat position").

- i** In the "Venetian blind" operating mode, the "variable position" setting can be selected separately for the Venetian blind height and for the slat position. For this reason, the ETS adapts the parameter selection and enlarges the setting options in this operating mode.

- i** The behaviour preset in this parameter will only be executed, if no function with a higher priority (e.g. safety) is activated at the time of shading.

- i** "internal scene recall" setting: For this setting, the scene function of the output must be enabled in the ETS. Otherwise, the positions approached at the beginning of sun shading are undefined positions. The scene position values stored in the actuator by a scene storage function will be approached as well. A delay configured for scene recalls has no influence on the recall of the scene value by the sun protection function.

- i** "Variable position" setting: After an ETS programming operation or after switch-on of the supply voltage the objects "sun protection - ...position" and "sun protection - slat position" must receive position values from the KNX. Otherwise the actuator does not position itself at the start of sun shading as it does not have any valid position data.

When the actuator is in operation, the position data can be updated at any time via the KNX even if the sun protection is active (e.g. by a weather station for the purpose of sun tracking the position). The actuator will then immediately approach the newly received positions if sun shading is active. If a function with a higher priority is active, the actuator stores the newly received position values and approaches them during a later shading operation.

The position data last received are not lost in a bus voltage failure.

Presetting a forced reference movement in the sun protection mode

If needed, a reference movement can be executed by forced-control in the sun protection mode at the beginning of a shading cycle, if fixed or variable position values or scene positions are to be approached or a scene is recalled. The execution of a reference movement by forced control at the beginning of shading can be used in a sun protection positioning operation to ensure that the curtains or slats are moved synchronously by different outputs to identical positions (e.g. in a long row of windows). Without the execution of reference travel by forced control, there might otherwise be positioning inaccuracies with a negative effect on the overall appearance of a building facade with the blinds let down.

A reference movement by forced control will always be executed in the simple sun protection mode, when the beginning of shading is signalled via the "Sunshine" object. Updates of the object from "Sun is shining" to "Sun is shining" do not initiate a reference movement if, at this time, the output is still in the sun protection position.

A reference movement by forced control will be executed in the extended sun protection mode, when the beginning of shading is signalled via the "Sun shading facade" object "Sunshine" object. Updates of the object from "Sun is shining" to "Sun is shining" will never initiate a reference movement. In this case, the sunshine signal must first change from 'sun is not shining' to 'sun is shining' before a new reference movement can take place.

A reference movement by forced control will always be executed for synchronisation purposes as described and also in such cases where the position data of the blind or the slats are known. No reference movement by forced control will be executed at the end of shading.

The sun protection function must be enabled on the parameter page "Relay outputs... -> VBO... - General -> Enabled functions" in order for the sun protection parameters to be visible.

- Activate the parameter "reference movement before every sun protection positioning operation" on the parameter page "Relay outputs... -> VBO... General -> Sunshine -> Sun protection start".

At the beginning of shading there is always a reference movement by forced control as described. The preset position will be approached after the end of the reference movement.

- Deactivate the parameter "reference movement before every sun protection positioning operation".
A reference movement at the beginning of sun protection will only be executed, if the position data are unknown, e.g. after an ETS programming operation or after switch-on of the power supply. In all other cases, the preset shading position will be approached immediately.
- i** A reference movement is the time required for a travel movement into the upper end position increased by 20% and additionally by the configured travel time extension. A reference travel is not retriggerable.
- i** Variable position preset: No reference movement will be executed, if new position values are preset via the KNX while the sun protection is active.
- i** "Venetian blind" operating mode: A terminated reference travel for the height of the blind also synchronizes the slat position at the same time.

Slat offset in the sun protection mode (only "Venetian blind" operating mode)

An offset can be specified for the slat position at the start of sun shading separated for each Venetian blind output, if fixed or variable slat position values are to be approached. If necessary, the slat offset can correct the fixed or variable nominal slat position and thus allow the creation of an individual shading situation, when the sun protection is active. The offset can be preset in two ways...

- The slat offset can be configured statically in the ETS. The configuration of a static offset value allows to vary the degree of shading in those parts of the building that are not exposed to full sunshine due to objects in front of the building. The variable slat angle adjusted by the sun protection control or the fixed angle specified in a parameter can thus be overridden so that the slats are always opened a bit wider than originally preset. Alternatively, the slats can also be closed completely by means of the static offset if too much sunlight is reflected into the room.
- The slat offset can additionally be adapted by the KNX via the separate communication object "sunshine protection - slat position offset". In this way, the desired slat offset can also be adjusted during an active shading cycle and independent of a direct operation as, for instance, the short time mode. Thus, it is possible, for instance, that persons in a room can correct the slat angle at any time 'manually' and individually by selecting another preset value at a push-button sensor or a visualisation. An offset preset via the object overwrites the value configured in the ETS.

The preset offset is taken into account in the sun protection mode for each positioning move during an active shading cycle (beginning of sunshine) and added to the predefined nominal slat position. The offset value can be varied within a range from

-100 % ... 0 ... 100 % so that the slats can be moved in both directions into the slat end positions. At an offset of "0 %", the actual slat position is always identical with the predefined nominal slat position for sun protection purposes.

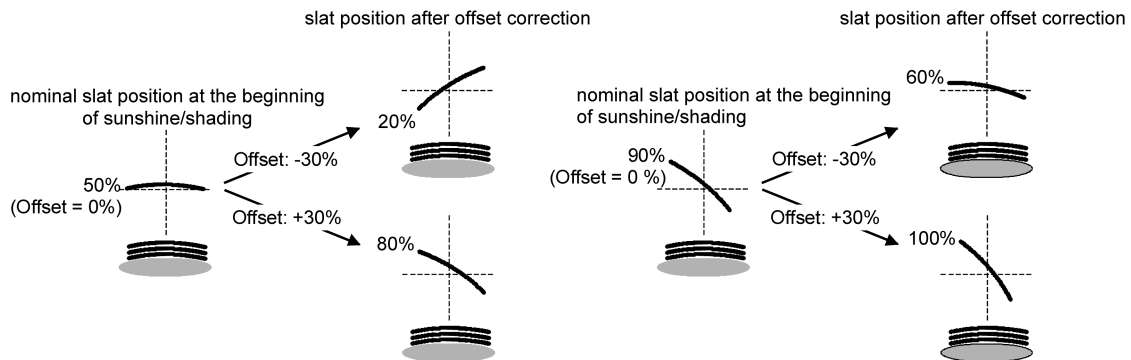

Image 16: Functional principle of slat offset
(example showing slat type 1 / slat type 2 identical)

The position value actually adjusted with the offset after adding the slat position value is always between 0 and 100%. Minimum and maximum position are thus determined by the slat end positions. These limits cannot be exceeded by specifying an greater offset. Example...

Slat position at the beginning of sunshine = 90%

Sunshine offset slat position = +30%

-> The resulting slat position is 100% as the end position is reached.

In acc. with the KNX data point type 6.001 (DPT_Percent_V8) the data format of the communication object "sun protection slat position offset" permits presetting positive and negative values in a range of -128 ... 0 ... +127. The actuator interprets the value received directly as an offset in %. Values below -100 or above +100 are limited to the minimum offset (-100%) and maximum offset (+100%) and evaluated accordingly.

An offset preset via the object overwrites the value configured in the ETS. In the event of a bus voltage failure, an offset value received via the communication object can be stored internally in a non-volatile memory so that the offset value last received is not lost even in case the power supply fails. As an alternative, the offset preset via the KNX can be reset (0%) in the event of a supply voltage failure with the result that the value configured in the ETS is again used in operation. The offset reaction preset in the event of bus voltage failure can be configured in the ETS.

Configuring the slat offset in the sun protection mode (only "Venetian blind" operating mode)

The sun protection function must be enabled on the parameter page "Relay outputs... -> VBO... - General -> Enabled functions" in order for the sun protection parameters to be visible.

The function must be configured for the "Venetian blind" operating mode.

The reaction at the beginning of sunshine must be configured to a fixed or variable position preset.

- Set the parameter "Offset the slat position during sunshine" on the parameter page
"Relay outputs... -> VBO... General -> Sun protection -> Beginning of sun protection" to "no offset".
Offset correction is deactivated. During shading (beginning of sunshine), the fixed or variable slat position will be approached without offset correction. The other parameters relating to offset configuration are hidden.
 - Set the parameter "offset of the slat position during sunshine" to "offset as parameter".
The static offset correction based on the parameter specification in the ETS is activated. During every shading operation (beginning of sunshine), the nominal slat position is always corrected by the configured offset value.
 - Set the parameter "offset of the slat position during sunshine" to "offset as parameter and via object".
The offset correction based on the parameter specification in the ETS and specification via the object is activated. The slat offset is preset by a fixed value configured in the ETS and can be adapted dynamically with a separate communication object. During every shading operation (beginning of sunshine), the nominal slat position is always corrected by the preset offset value.
 - Set the parameter "Slat offset position (-100 ... 100%)" to the desired offset value.
The configured value defines the static offset correction of the slat position. The configured value can be re-adjusted via the "sun protection - offset slat position object" if the communication object has been enabled.
 - Deactivate the parameter "store in case of bus voltage failure".
The value received via the object will only be stored temporarily in volatile memory. The received value only replaces the configured value until the actuator is reinitialised. After the initialisation, the offset value configured in the ETS will be used again.
 - Activate the parameter "store in case of bus voltage failure".
The value received via the object will be stored in case of bus voltage failure in a non-volatile memory of the actuator. The originally configured offset value is definitely overwritten in the process. Only a new ETS programming operation sets the offset back to the configured value.
- i** An offset value received via the KNX is stored temporarily or permanently in the actuator and taken into account during the next shading operation. The reception of an offset value during an active shading phase (beginning of sunshine active) results in immediate and visible correction of the offset angle by the output.
- i** After an ETS programming operation, the offset is always set to the value configured in the ETS.

- i** The slat offset has no influence on the behaviour of an output at the end of a shading phase (end of sunshine).

Presetting the reaction at the end of sunshine

At the end of the shading phase – if applicable, after the end of the delay time – the output concerned will show the preset reaction, if no function with a higher priority is active at the time of deactivation. The preset reaction will also not be executed at the end of sun shading, if the sunshine signal is overridden on account of priority settings by a direct operation.

The reaction for the end of sunlight is set on the parameter page "Relay outputs... -> VBO... General -> Sun protection -> Sun protection end".

The sun protection function must be enabled on the parameter page "Relay outputs... -> VBO... - General -> Enabled functions" in order for the sun protection parameters to be visible.

- Set the parameter "at the end of sunshine" to "no reaction".
At the end of shading, the relay of the output shows no reaction. Any travel movements still in progress at this instant will still be finished.
- Set the parameter "at the end of sunshine" to "raising" or "opening".
The actuator raises the blind/shutter or opens the venting louvre / roof window at the end of shading.
- Set the parameter "at the end of sunshine" to "lowering" or "closing".
The actuator lowers the blind/shutter or closes the venting louvre / roof window at the end of shading.
- Set the parameter "at the end of sunshine" to "stop".
At the end of shading, the actuator switches the relays of the output to the "stop" position. A travel movement, if any, will be interrupted.
- Set the parameter "at the end of sunshine" to "tracking the position".
At the end of shading, the output will be set to the state last adjusted statically before sun protection or to the state tracked and internally stored during sun protection. The position objects, the long-time object and the scene function are tracked.

- i** The behaviour preset in this parameter will only be executed, if no function with a higher priority (e.g. safety) is activated when the sun protection is enabled or when a direct operation has not overridden the sunshine signal on account of priority settings.

- i** Parameter setting "tracking the position": The actuator can track absolute positions (position telegram, scene value) at the end of sun protection only if the position data are known and if the positions have been predefined. There is otherwise no reaction at the end of sun shading.
Position data can be tracked, if the output was in a defined position before the sun protection function or if a new position telegram was received via the posi-

tion objects during the sun protection. In the latter case, a reference movement will be executed at the end of sun protection, if the position before or during the sun protection was unknown.

Known slat positions will also be tracked as described. This is also the case, when the height of the Venetian blind is unknown.

Long time travel movements (movements without position preset) will always be tracked.

11.8.1 Sun protection function parameters

Relay outputs... -> VBO... - General -> Enabled functions

Sun protection function	Checkbox (yes / no)
The sun protection function of the Venetian blind output can be enabled here.	

Relay outputs... -> VBO... - General -> Sun protection

Priority of sun protection with respect to direct operation	same priority higher priority lower priority
This parameter defines the priority of the sun protection function with respect to direct operation. same priority: The sun protection can be overridden by direct operation and vice versa. Only after the next reception of a "sun is shining" signal will the sun protection mode be activated again. higher priority: The sun protection has the higher priority and cannot be aborted by a direct operation. lower priority: The direct operation has the higher priority and cannot be aborted by sun protection. The sun protection can be activated only after an enabling movement into the upper end position initiated by a direct operation has occurred without interruption. Direct operation = long-time/short-time operation, positioning via objects, scenes.	

Object polarity "sunshine"	sunshine = 1; no sunshine = 0 sunshine = 0; no sunshine = 1
This parameter defines the polarity of the input object "sunshine".	

Relay outputs... -> VBO... General -> Sunshine -> Sun protection start

Delay at the beginning of sunshine	0...59 min 0... 30 ...59 s
The telegram received via the object "Sunshine" for activation of shading (depending on polarity) can be evaluated with a time delay. A time setting of "0" in the parameters deactivates the respective delay time. In this case, the state of shading is evaluated immediately.	

At the beginning of sunshine	No reaction raising lowering stop internal scene recall Venetian blind or slat position fixed Venetian blind position fixed / slat position variable slat position fixed / Venetian blind position variable Venetian blind and slat position variable
<p>This parameter defines the behaviour of the output at the beginning of shading – if applicable, after the end of the delay time.</p> <p>no reaction: At the beginning of shading, the output switches over to sun protection while the relays of the output show no reaction. Any travel movements still in progress at this instant will still be finished.</p> <p>raising: At the beginning of shading, the actuator raises the blind/shutter.</p> <p>lowering: At the beginning of shading, the actuator lowers the blind/shutter.</p> <p>stop: At the beginning of shading, the actuator switches the relays of the output to the "stop" position. A travel movement, if any, will be interrupted.</p> <p>Internal scene recall: At the beginning of shading, the actuator recalls the position values for the affected output which were preset in the scene configuration. This is not a scene recall as in direct operation, but only an approach of the corresponding scene position values.</p> <p>Venetian blind or slat position fixed: At the beginning of shading, the output moves to a configured fixed Venetian blind and slat position.</p> <p>Venetian blind position fixed / slat position variable: At the beginning of shading, the output controls the approach to a configured fixed Venetian blind position and to slat position preset by a separate object and thus variable.</p> <p>slat position fixed / Venetian blind position variable: At the beginning of shading, the output controls the approach to a configured fixed slat position and to a Venetian blind position preset by a separate object and thus variable.</p> <p>Venetian blind and slat position variable: At the beginning of shading, the output controls the approach to the Venetian blind and slat positions preset by two separate objects and thus variable.</p> <p>This parameter is only visible in the Venetian blind operating mode.</p>	

At the beginning of sunshine	No reaction raising lowering stop internal scene recall fixed position variable position
<p>This parameter defines the behaviour of the output at the beginning of shading – if applicable, after the end of the delay time.</p> <p>no reaction: At the beginning of shading, the output switches over to sun protection while the relays of the output show no reaction. Any travel movements still in progress at this instant will still be finished.</p> <p>raising: At the beginning of shading, the actuator raises the blind/shutter.</p> <p>lowering: At the beginning of shading, the actuator lowers the blind/shutter.</p> <p>stop: At the beginning of shading, the actuator switches the relays of the output to the "stop" position. A travel movement, if any, will be interrupted.</p> <p>Internal scene recall: At the beginning of shading, the actuator recalls the position values for the affected output which were preset in the scene configuration. This is not a scene recall as in direct operation, but only an approach of the corresponding scene position values.</p> <p>fixed position: At the beginning of shading, the output controls the approach to a configured fixed position.</p> <p>variable position: At the beginning of shading, the output controls the approach to a position preset by a separate object and thus variable.</p> <p>This parameter is only visible in the shutter/awning operating mode.</p>	

At the beginning of sunshine	No reaction open close stop internal scene recall fixed position variable position
------------------------------	---

This parameter defines the behaviour of the output at the beginning of shading – if applicable, after the end of the delay time.

no reaction: At the beginning of shading, the output switches over to sun protection while the relays of the output show no reaction. Any travel movements still in progress at this instant will still be finished.

open: At the beginning of shading, the actuator opens the venting louvre / roof window.

close: At the beginning of shading, the actuator closes the venting louvre / roof window.

stop: At the beginning of shading, the actuator switches the relays of the output to the "stop" position. A travel movement, if any, will be interrupted.

Internal scene recall: At the beginning of shading, the actuator recalls the position values for the affected output which were preset in the scene configuration. This is not a scene recall as in direct operation, but only an approach of the corresponding scene position values.

fixed position: At the beginning of shading, the output controls the approach to a configured fixed position.

variable position: At the beginning of shading, the output controls the approach to a position preset by a separate object and thus variable.

This parameter is only visible in the "venting louvre / roof window" operating mode.

Internal scene	Scene 1 Scene 2 ... Scene 64
----------------	--

This parameter defines the internal scene which is recalled at the beginning of shading.

This parameter is only visible, if the parameter "At the beginning of sunshine" is set to "internal scene recall".

Fixed Venetian blind position	same as configured value no change in current position
<p>The fixed Venetian blind position at the beginning of shading can either be preset statically by a separate parameter or basically adjusted to the value prevailing at the time of shading activation, i.e. remain unchanged.</p> <p>same as configured value: At the beginning of shading, the configured Venetian blind position will be approached.</p> <p>no change in current position: At the beginning of shading, the current Venetian blind position will be maintained. In this case, the output behaves as if only the slat were positioned as a result of shading.</p> <p>This parameter is only visible, if the Venetian blind is to approach a fixed position at the beginning of shading.</p> <p>This parameter is only visible in the "Venetian blind with slat" operating mode.</p>	
Position of blind (0...100%)	0... 50 ...100
<p>This parameter sets the fixed position of the Venetian blind to be approached at the beginning of shading.</p> <p>This parameter is only visible, if the parameter "Fixed position of Venetian blind" is set to "as specified by parameter".</p> <p>This parameter is only visible in the "Venetian blind with slat" operating mode.</p>	
Fixed position of slat (0...100%)	0... 50 ...100
<p>This parameter sets the fixed position of the slat to be approached at the beginning of shading and, as the case may be, after positioning of the Venetian blind.</p> <p>This parameter is only visible, if the slat is to approach a fixed position at the beginning of shading.</p> <p>This parameter is only visible in the "Venetian blind with slat" operating mode.</p>	
Fixed roller shutter / awning position	same as configured value no change in current position
<p>The fixed position of the roller shutter or awning at the beginning of shading can either be preset statically by a separate parameter or basically adjusted to the value prevailing at the time of shading activation, i.e. remain unchanged.</p> <p>same as configured value: At the beginning of shading, the configured shutter or awning position will be approached.</p> <p>no change in current position: At the beginning of shading, the current shutter or awning position will be maintained. Any movements in progress at the time of shading activation will be finished.</p> <p>This parameter is only visible when the shutter or awning should approach a fixed position value at the beginning of sun shading.</p> <p>This parameter is only visible in the shutter/awning operating mode.</p>	

Position of shutter/awning (0...100%)	0... 50 ...100
<p>This parameter sets the fixed position of the shutter or awning to be approached at the beginning of shading.</p> <p>This parameter is only visible, if the parameter "Fixed position of shutter / awning" is set to "as specified by parameter".</p> <p>This parameter is only visible in the shutter/awning operating mode.</p>	
Fixed position of venting louvre	same as configured value no change in current position
<p>The fixed venting louvre position at the beginning of shading can either be preset statically by a separate parameter or basically adjusted to the value prevailing at the time of shading activation, i.e. remain unchanged.</p> <p>same as configured value: At the beginning of shading, the configured venting louvre position will be approached.</p> <p>no change in current position: At the beginning of shading, the current venting louvre position will be maintained. Any movements in progress at the time of shading activation will be finished.</p> <p>This parameter is only visible if the venting louvre is to approach a fixed position at the beginning of shading.</p> <p>This parameter is only visible in the "venting louvre / roof window" operating mode.</p>	
Position of venting louvre (0...100%)	0... 50 ...100
<p>This parameter sets the fixed position of the venting louvre to be approached at the beginning of shading.</p> <p>This parameter is only visible, if the parameter "Fixed position of venting louvre" is set to "as specified by parameter".</p> <p>This parameter is only visible in the "venting louvre / roof window" operating mode.</p>	
Reference travel before every sun protection positioning operation	Checkbox (yes / no)
<p>A forced reference travel of the drive is performed before sun protection positioning. A reference movement is a positioning movement into the upper end position or into the completely open position. By means of a forced reference movement, drives connected to different outputs can be synchronised. If no synchronising movement is forced, the actuator performs a reference movement only once after return of the power supply.</p>	
Relay outputs... -> VBO... - General -> Sunshine -> Sun protection end	
Delay at the end of sunshine Minutes (0...59)	0... 59
<p>The telegram received via the object "Sunshine" for deactivation of shading (depending on polarity) can be evaluated with a time delay.</p> <p>Setting the delay time minutes.</p>	

Seconds (0...59)	0... 30 ...59
<p>Setting the delay time seconds. A time setting of "0" in the parameters deactivates the respective delay time. In this case, the state of shading is evaluated immediately.</p>	
At the end of sunshine	No reaction raising / opening lowering / closing stop tracking the position
<p>This parameter defines the behaviour of the output at the end of shading – if applicable, after the end of the delay time.</p> <p>no reaction: At the end of shading, the output quits the sun protection mode and the relays of the output show no reaction. Any travel movements still in progress at this instant will still be finished.</p> <p>raising / opening: The actuator raises the blind/shutter or opens the venting louvre / roof window at the end of shading.</p> <p>lowering / closing: The actuator lowers the blind/shutter or closes the venting louvre / roof window at the end of shading.</p> <p>stop: At the end of shading, the actuator switches the relays of the output to the "stop" position. A travel movement, if any, will be interrupted.</p> <p>tracking the position: At the end of shading, the output will be set to the state last adjusted before sun protection or to the state tracked and internally stored during sun protection. The position objects, the long-time object and the scene function are tracked.</p> <p>The behaviour preset in this parameter will only be executed if no function with a higher priority (e.g. safety) is activated at the end of shading.</p>	
Internal scene	Scene 1 Scene 2 ... Scene 64
<p>This parameter defines the internal scene which is recalled at the end of shading. This parameter is only visible, if the parameter "At the end of sunshine" is set to "internal scene recall".</p>	

Fixed Venetian blind position	same as configured value no change in current position
<p>The fixed Venetian blind position at the end of shading can either be preset statically by a separate parameter or basically remain at the value set or tracked by the shading operation.</p> <p>same as configured value: At the end of shading, the configured Venetian blind position will be approached.</p> <p>no change in current position: At the end of shading, the current Venetian blind position will be maintained. In this case, the output behaves as if only the slat were positioned as a result of the end of shading.</p> <p>This parameter is only visible, if the Venetian blind is to approach a fixed position at the end of shading.</p> <p>This parameter is only visible in the Venetian blind operating mode.</p>	
Position of blind (0...100%)	0... 50 ...100
<p>This parameter sets the fixed position of the Venetian blind to be approached at the end of shading.</p> <p>This parameter is only visible, if the parameter "Fixed position of Venetian blind" is set to "as specified by parameter".</p> <p>This parameter is only visible in the "Venetian blind with slat" operating mode.</p>	
Fixed position of slat (0...100%)	0... 50 ...100
<p>This parameter sets the fixed position of the slat to be approached at the end of shading and, as the case may be, after positioning of the Venetian blind.</p> <p>This parameter is only visible, if the slat is to approach a fixed position at the beginning of shading.</p> <p>This parameter is only visible in the "Venetian blind with slat" operating mode.</p>	
Fixed roller shutter / awning position	same as configured value no change in current position
<p>The fixed position of the roller shutter or awning at the end of shading can either be preset statically by a separate parameter or basically adjusted to the value prevailing at the time of shading activation, i.e. remain unchanged.</p> <p>same as configured value: At the end of shading, the configured shutter or awning position will be approached.</p> <p>no change in current position: At the end of shading, the current shutter or awning position will be maintained. Any movements in progress at the time of shading activation will be finished.</p> <p>This parameter is only visible, if the shutter or awning is to approach a fixed position at the end of shading.</p> <p>This parameter is only visible in the shutter/awning operating mode.</p>	

Position of shutter/awning (0...100%)	0... 50 ...100
<p>This parameter sets the fixed position of the shutter or awning to be approached at the end of shading.</p> <p>This parameter is only visible, if the parameter "Fixed position of shutter/awning" is set to "as specified by parameter".</p> <p>This parameter is only visible in the shutter/awning operating mode.</p>	
Fixed position of venting louvre	same as configured value no change in current position
<p>The fixed venting louvre position at the end of shading can either be preset statically by a separate parameter or basically adjusted to the value prevailing at the time of shading activation, i.e. remain unchanged.</p> <p>same as configured value: At the end of shading, the configured venting louvre position will be approached.</p> <p>no change in current position: At the end of shading, the current venting louvre position will be maintained. Any movements in progress at the time of shading activation will be finished.</p> <p>This parameter is only visible if the venting louvre is to approach a fixed position at the end of shading.</p> <p>This parameter is only visible in the "venting louvre / roof window" operating mode.</p>	
Position of venting louvre (0...100%)	0... 50 ...100
<p>This parameter sets the fixed position of the venting louvre to be approached at the end of shading.</p> <p>This parameter is only visible, if the parameter "Fixed position of venting louvre" is set to "as specified by parameter".</p> <p>This parameter is only visible in the "venting louvre / roof window" operating mode.</p>	

11.8.2 Object sun protection function

Object no.	Function	Name	Type	DPT	Flag
32, 79 ...	Sun protection - Sunshine - Activ- ate / deactivate	Venetian blind... - Input	1-bit	1.001	C, -, W, -, U
1-bit object for activation or deactivation of sun shading in the simple or extended sun protection mode (sun / no sun). The polarity can be configured.					
Object no.	Function	Name	Type	DPT	Flag
33, 80 ...	Sun protection - ...position	Venetian blind... - Input	1-byte	5.001	C, -, W, -, U
1-byte object for presetting a variable position value (0...255) for the height of the Venetian blind or shutter or the venting louvre / roof window position in direct operation when the sun protection is active.					
Object no.	Function	Name	Type	DPT	Flag
34, 81...	Sun protection - slat position	Venetian blind... - Input	1-byte	5.001	C, -, W, -, U
1-byte object for presetting a variable slat position value (0...255) when the sun protection is active.					
Object no.	Function	Name	Type	DPT	Flag
35, 82 ...	Sun protection - Slat position - Offset	Venetian blind... - Input	1-byte	6.001	C, -, W, -, U
1-byte object for presetting a slat position angle (-100% ... +100% / smaller or larger position angles are treated as + or -100%) for 'manual' readjustment of the slat position when the sun protection is active.					

11.9 Twilight function

In "Venetian blind with slats" and "Shutter/awning" operating modes, the twilight function can be activated. The twilight function allows the blind/shutter to be closed to provide privacy in the evening and opened in the morning, for example.

The reaction of a specific output at the beginning of the twilight function can be pre-set in the ETS. It is possible, among other things, to approach the upper or lower end position or configured position values.

The reaction at the end of the twilight function can also be set. In this situation, the blind/shutter can move to an end position, for example, or show no special reaction. Tracking of positions is possible as well.

Twilight mode is started and also ended using a 1-bit object with the data point type 1.003 DPT_Enable. The value "1" means that the twilight function is active. The value "0" means that the twilight function is not active.

Activating the twilight function

The twilight function can be activated independently for each Venetian blind or roller shutter/awning output on the parameter page "Relay outputs... -> VBO... - Enabled functions".

The operating mode must be set to "Venetian blind with slats" or "Shutter/awning" mode.

- Activate the checkbox "Twilight function".
The parameter page "Relay outputs... -> VBO... - Twilight function" is enabled and the twilight function is activated.
- i** The twilight function cannot be configured in the "Venting louvre / roof window" operating mode.

Setting the twilight function

The twilight function can be activated independently for each Venetian blind or roller shutter/awning output using the parameter on the parameter page "Relay outputs... -> VBO... - Enabled" functions. If the function is enabled, the parameter page "Relay outputs... -> VBO... - General -> Twilight function" is shown.

The twilight function must be enabled.

- Set the parameter "Start of twilight function" to "No reaction".
At the beginning of the twilight function, the relays of the output show no reaction. Any travel movements still in progress at this instant will still be finished.
- Set the parameter "Start of twilight function" to "raising".
At the beginning of the twilight function, the actuator raises the blind/shutter.
- Set the parameter "Start of twilight function" to "lowering".
At the beginning of the twilight function, the actuator lowers the blind/shutter.

- Set the parameter "Start of twilight function" to "Approach position". Set the position of the Venetian blind and the slats or the position of the shutter/awning.
At the beginning of the twilight function, the actuator recalls the set position value for the output concerned.
- Set the parameter "Start of twilight function" to "Internal scene recall". Configure the internal scene to be recalled (parameter "Scene number").
At the beginning of the twilight function, the actuator recalls the position value for the output concerned which was preset in the scene configuration. This is not a scene recall as in direct operation, but only an approach to the corresponding scene position value.

At the end of the twilight function, the output concerned will show the preset reaction if no function with a higher priority is active at the time of deactivation.

The twilight function must be enabled.

- Set the parameter "End of twilight function" to "No reaction".
At the end of the twilight function, the relay of the output shows no reaction. Any travel movements still in progress at this instant will still be finished.
- Set the parameter "End of twilight function" to "raising".
The actuator raises the curtain.
- Set the parameter "End of twilight function" to "lowering".
The actuator lowers the curtain.
- Set the parameter "End of twilight function" to "Approach position". Set the position of the Venetian blind and the slats or the position of the shutter/awning.
At the beginning of the twilight function, the actuator recalls the set position value for the output concerned.
- Set the parameter "End of twilight function" to "tracking the position".
At the end of the twilight function, the output will be set to the state last set statically before the twilight function or to the state tracked and internally stored during the twilight function. The position objects, the long-time object and the scene function are tracked.

11.9.1 Parameters for the twilight function

Relay outputs... -> VBO... General -> Sunshine -> Sun protection start

Start of twilight function	No reaction raising lowering approach position internal scene recall
<p>The behaviour of the output at the beginning of twilight is set here.</p> <p>no reaction: At the beginning of twilight, the relays of the output show no reaction. Any travel movements still in progress at this instant will still be finished.</p> <p>raising: The actuator raises the blind/shutter at the beginning of twilight.</p> <p>lowering: The actuator lowers the blind/shutter at the beginning of twilight.</p> <p>approach position: The output moves to a fixed parameterised blind/shutter position at the beginning of twilight.</p> <p>Internal scene recall: At the beginning of twilight, the actuator recalls the position values for the affected output which were preset in the scene configuration. This is not a scene recall as in direct operation, but only an approach of the corresponding scene position values.</p>	
Venetian blind position	0 ... 60...100%
Slat position	0 ... 100%
Shutter/awning position	0 ... 60...100%
<p>This parameter sets the blind/shutter position value to be approached at the beginning of twilight.</p> <p>This parameter is only visible if the parameter "Start of twilight function" is set to "approach position".</p> <p>These parameters are visible, depending on the blind/shutter type.</p>	
Internal scene recall at start of twilight	0 ... 10 ... 64
<p>This parameter defines the internal scene which is recalled at the beginning of twilight.</p> <p>This parameter is only visible if the parameter "Start of twilight function" is set to "Internal scene recall".</p>	

End of twilight function	No reaction raising lowering tracking the position approach position
<p>The behaviour of the output at the end of twilight is set here.</p> <p>no reaction: At the end of twilight, the relays of the output show no reaction. Any travel movements still in progress at this instant will still be finished.</p> <p>raising: The actuator raises the blind/shutter at the end of twilight.</p> <p>lowering: The actuator lowers the blind/shutter at the end of twilight.</p> <p>tracking the position: At the end of twilight, the output will be set to the state last adjusted before twilight or to the state tracked and internally stored during twilight. The position objects, the long-time object and the scene function are tracked. The behaviour preset in this parameter will only be executed if no function with a higher priority (e.g. safety) is activated at the end of twilight.</p> <p>approach position: The output moves to a fixed parameterised blind/shutter position at the end of twilight.</p>	

Venetian blind position	0...100%
Slat position	0...100%
Shutter/awning position	0...100%
<p>This parameter sets the blind/shutter position value to be approached at the end of twilight.</p> <p>This parameter is only visible if the parameter "End of twilight function" is set to "approach position".</p> <p>These parameters are visible, depending on the blind/shutter type.</p>	

11.9.2 Object list for twilight function

Object no.	Function	Name	Type	DPT	Flag
65, 112, 159, 206, 253, 300, 347, 394, 441, 488, 535, 582	Twilight function - Activate / deactivate	Venetian blind... - Input	1-bit	1.003	C, -, W, -, U
1-bit objects for switchover between day and night operation					

11.10 Scene function

An actuator can hold up to 16 scenes for each output and store scene position values for the height of a Venetian blind, shutter or awning or the venting louvre / roof window position. In the 'Venetian blinds' operating mode, the user can also preset slat positions. The scene values are recalled or stored via a separate scene extension object. The data point type of the extension object permits addressing of all scenes.

The scene function must be enabled on the parameter page "Relay outputs... -> VBO... - General -> Enabled functions" for each Venetian blind output, in order for the required communication objects and parameters (on the parameter page "Relay outputs... -> VBO... - General -> Scenes") to become visible.

The number of scenes used can be selected anywhere in the range 1 to 16. The parameter "Number of scenes" decides how many scenes are visible for the switching output in the ETS and can therefore be used. It is possible to specify which scene number (1 ... 64) controls each scene.

Like the output control via short time, long time or position telegrams, the scene function should be assigned to direct operation. For this reason, a recalled scene position can at any time be overridden by a manual control or a safety function. The scene position last recalled can also be readjusted by other telegrams of the direct operation mode. The priority of direct operation and also of the scene function can be configured with respect to the sun protection function (cf. "Sun protection function").

Presetting a scene recall delay

Each scene recall of an output can optionally also be delayed. With this feature, dynamic scene sequences can be configured if several scene outputs are combined with cyclical scene telegrams.

Precondition

The scene function must be enabled on the parameter page "Relay outputs... -> VBO... - General -> Enabled functions".

- On the parameter page "Relay outputs... -> VBO... - General -> Scenes" activate the parameter "Delay scene recall".

The delay time is now activated and can be configured separately. The delay only influences the scene recall of the switching output. The delay time is started on arrival of a recall telegram. The corresponding scene will be recalled and the output set to the respective scene position value only after this time has elapsed.

- i** Each scene recall telegram restarts the delay time and retriggers it. If a new scene recall telegram is received while a delay is active (scene recall not yet executed), the old (and not yet recalled scene) will be rejected and only the scene last received executed.
- i** The scene recall delay has no influence on the storage of scene values. A scene storage telegram within a scene recall delay terminates the delay and thus the scene recall.

Presetting the behaviour during ETS programming

When a scene is saved, the scene position values are stored permanently in the device. To prevent the stored values from being replaced during ETS programming of the application or of the parameters by the originally programmed scene position values, the actuator can inhibit overwriting of the scene values. As an alternative, the original values can be reloaded into the device during each programming run of the ETS.

Precondition

The scene function must be enabled on the parameter page "Relay outputs... -> VBO... - General -> Enabled functions".

- On the parameter page "Relay outputs... -> VBO... - General -> Scenes", activate the parameter "Overwrite values stored in the device during the ETS programming operation".

During each ETS programming of the application or of the parameters, the scene position values configured in the ETS for the output concerned will be programmed into the actuator. Scene values stored in the device by means of a storage function will be overwritten, if any.

- Deactivate the parameter "Overwrite values stored in the device during the ETS programming operation".

Scene position values stored in the device with a storage function will be maintained. If no scene values have been stored, the position values last programmed in the ETS remain valid.

- i** When the actuator is commissioned for the first time, this parameter should be activated so that the output is initialised to valid scene position values.

Presetting scene numbers and scene positions

The scene number (1...64) with which the scene is addressed, i.e. recalled or stored, must be determined for each internal scene of the output. The data point type of the scene extension object permits addressing of all scenes.

In addition to specifying the scene number, it must be defined which position is to be set for the output in case of a scene recall. In the "Venetian blind with slat" operating mode, two position values must be defined for the Venetian blind position and slat position.

Precondition

The scene function must be enabled on the parameter page "Relay outputs... -> VBO... - General -> Enabled functions".

- On the parameter page "Relay outputs... -> VBO... - General -> Scenes", set the parameter for each scene to the numbers with which the scenes are to be addressed.

A scene can be addressed with the configured scene number. A setting of "0" deactivates the corresponding scene so that neither recalling nor storage is possible.

- i** If the same scene number is configured for several scenes, only the scene with the lowest sequential number will be addressed. The other scenes will be ignored in this case.
 - On the parameter page "Relay outputs... -> VBO... General -> Scenes" for each scene set the parameters "position of Venetian blind", "position of shutter/awning", "position of venting louvre / roof window" and "position of slat " to the desired position value (0...100%).
During a scene recall, the configured scene position is recalled and set on the output.
- i** The configured scene positions are then adopted in the actuator during programming with the ETS only if the parameter "Overwrite values stored in the device during ETS download" is activated.
- i** Before approaching the required scene position, the actuator may perform a reference movement, if the current position data is unknown (e.g. after an ETS programming operation or after switch-on of the bus voltage).

Presetting storage behaviour

The current position value of a Venetian blind, shutter, awning, venting louvre and also of a slat can be stored internally via the extension object on reception of a scene storage telegram. The position value can be influenced before storage by all functions of the output (e.g. short-time and long-time operation, scene recall telegram, safety and sun protection function and manual control).

Precondition

The scene function must be enabled on the parameter page "Relay outputs... -> VBO... - General -> Enabled functions".

- On the parameter page "Relay outputs... -> VBO... - General -> Scenes" activate the parameter "storage function" for each scene.
The storage function is activated for the scene in question. On reception of a storage telegram via the "Scene extension" object, the current position value will be internally stored.
- Deactivate the parameter "storage function" for each scene.
The storage function is deactivated for the scene in question. A storage telegram received via the "scene extension" object will be rejected.

Optionally, a visual feedback via the output can be signalled when executing a storage command. As feedback, the drive connected to the output moves for the configured travel time of the visual feedback in the opposite direction to the last travel command and then back again. This enables the system operator to determine locally whether the desired scene position has been saved correctly in the actuator.

- i** The visual feedback is only available in the "Venetian blind with slat" and "shutter/awning" operating modes.

- On the parameter page "Relay outputs... -> VBO... - General -> Scenes" activate the parameter "visual feedback for storage function". Set the duration of the travel movement for the directional travel of the visual feedback for the parameters "Venetian blind travel time" or "shutter/awning travel time".

When a storage function is executed, the visual feedback is activated immediately. The output travels in the opposite direction of the last move command and then back again for the duration of the configured travel time.

- Deactivate the parameter "visual feedback for storage function".

When storing a scene, the visual feedback is not executed. The actuator adopts the current position value of the output without special feedback.

- i** The visual feedback is only executed if no other function with a higher priority (e.g. safety function) is active in the moment when the memory function is active.

11.10.1 Scene function parameters

Relay output... -> VBO... - General -> Enabled functions

Scene function	Checkbox (yes / no)
This parameter can be used disable or to enable the scene function.	

Relay output... -> VBO... - General: -> Scenes

Delay scene recall	Checkbox (yes / no)
A scene is recalled via the scene extension object. If required, the scene recall can be delayed on reception of a recall telegram (parameter activated). The recall is alternatively made immediately on reception of the telegram (parameter deactivated).	

Delay time	0...59 min 0...10...59 s
This parameter specifies the length of the scene delay time.	

Visual feedback for storage function	Checkbox (yes / no)
<p>Optionally, a visual feedback via the output can be signalled when executing a storage command. As feedback, the drive connected to the output moves for the configured travel time of the visual feedback in the opposite direction to the last travel command and then back again.</p> <p>Parameter activated: When a storage function is executed, the visual feedback is activated immediately. The output travels in the opposite direction of the last move command and then back again for the duration of the configured travel time.</p> <p>Parameter deactivated: When storing a scene, the visual feedback is not executed. The actuator adopts the current position value of the output without special feedback.</p> <p>This parameter is only available in the "Venetian blind with slat" and "shutter/awning" operating modes.</p>	

Venetian blind travel time	1...2...59 s
Setting the travel time for the visual feedback.	
This parameter is only available if the visual feedback is used and the operating mode is set to "Venetian blind with slat".	

Shutter/awning travel time	1...2...59 s
Setting the travel time for the visual feedback.	
This parameter is only available if the visual feedback is used and the operating mode is set to "shutter/awning".	

Overwrite values stored in the device during the ETS programming operation	Checkbox (yes / no)
During storage of a scene, the scene position values are stored internally to memory in the device. To prevent the stored values from being replaced during ETS programming by the originally programmed scene position values, the actuator can inhibit overwriting of the scene values (parameter deactivated). As an alternative, the original values can be reloaded into the device during each programming run of the ETS (parameter activated).	
Number of scenes	1...10...16
This parameter defines how many scenes are visible for the output in the ETS and can therefore be used.	
Scene number	0...1*...64 *: The predefined scene number is dependent on the scene.
It is possible to preset which scene number (1 ... 64) controls each scene. A setting of "0" deactivates the corresponding scene so that neither recalling nor storage is possible. If the same scene number is configured for several scenes, only the scene with the lowest sequential number will be addressed. The other scenes will be ignored in this case.	
Venetian blind position	0*...100% *: The predefined position is dependent on the scene.
This parameter is used for configuring the position of the Venetian blind, which is set when the scene is recalled. This parameter is only available in the "Venetian blind with slat" operating mode.	
Slat position	0*...100% *: The predefined position is dependent on the scene.
This parameter is used for configuring the position of the slat, which is set when the scene is recalled. This parameter is only available in the "Venetian blind with slat" operating mode.	
Shutter/awning position	0*...100% *: The predefined position is dependent on the scene.
This parameter is used for configuring the position of the shutter or awning , which is set when the scene is recalled. This parameter is only available in the "Shutter/awning" operating mode.	

Venting louvre / roof window position	0*...100% *: The predefined position is dependent on the scene.
<p>This parameter is used for configuring the position of the venting louvre or roof window, which is set when the scene is recalled.</p> <p>This parameter is only available in the "venting louvre / roof window" operating mode.</p>	
Memory function	Checkbox (yes / no)
<p>If the parameter is activated, the storage function of the scene is enabled. The current position value can then be stored internally via the extension object on receipt of a storage telegram. If the parameter is deactivated, the storage telegrams are rejected.</p>	

11.10.2 Object list scene function

Object no.	Function	Name	Type	DPT	Flag
24, 48...	Scenes - Extension	Venetian blind... - Input	1-byte	18.001	C, (R), W, -, A
1-byte object for polling or saving a scene.					

11.11 Disabling function and forced position

A disabling function, or alternatively, a forced position function can be configured for each Venetian blind output. In this respect, only one of these functions can be enabled for one Venetian blind output.

Presetting disabling function

During an active disabling function, the KNX control of the output concerned is overridden and locked. The disabling function has the second highest priority after manual control. Therefore, an active disabling function overrides the sun protection function and the direct operation (short-time, long-time telegram, scenes, positioning, central). Permanent locking for service purposes (drive stop) or as lockout protection (raising Venetian blind), for example, can also be overridden.

The deactivation of the disabling function can optionally take place using an additional 1-bit acknowledgement object. This prevents the deactivation of the disabling function by the disabling object.

- On the parameter page "Relay outputs... -> VBO... - General -> Enabled functions" Set the parameter "disabling function / forced position" to "disabling function".

The disabling function is enabled. The communication object "Disabling function - Activate / deactivate" and the parameters of the disabling function on the parameter page "Relay output... -> VBO... - General -> Disabling function" become visible. The polarity of the disabling object is predefined (1 = output disabled, 0 = output enabled).

- Set the parameter "Beginning of the disabling function" to the required behaviour.

At the beginning of the disabling function (ON telegram to the disabling object), the configured behaviour will be executed and the bus control of the output locked.

no reaction: The relay of the output shows no reaction and remains in the position last set.

stop: At the beginning of the disabling function, the actuator switches the relays of the output to the "stop" position. A travel movement, if any, will be interrupted.

raising / opening: The actuator raises the blind or opens the venting louvre / roof window.

lowering / closing: The actuator lowers the blind/shutter or closes the venting louvre / roof window.

Approach position: At the beginning of the disabling function, the connected drive can approach a position (0...100%) specified by further parameters. If Venetian blinds are controlled with the device, the slats can be positioned in-

dependently. The actuator performs a reference movement before the position approach, because the current position at the time of the disabling function is unknown.

For disabling function without acknowledgement object...

- Deactivate the parameter "Use acknowledgement".
No additional acknowledgement object is available. The disabling function is deactivated via the disabling object by means of an "OFF" telegram.
- Set the parameter "End of the disabling function" to the required behaviour.
At the end of the disabling function, the configured behaviour will be executed and the bus control of the output enabled again.

no reaction: The relay of the output shows no reaction and remains in the position last set.

stop: At the end of the disabling function, the actuator switches the relays of the output to the "stop" position. A travel movement, if any, will be interrupted.

raising / opening: The actuator raises the blind or opens the venting louvre / roof window.

lowering / closing: The actuator lowers the blind/shutter or closes the venting louvre / roof window.

tracking the position: The last switching state received during the disabling function or the last position set before the disabling function (terminated travel movement) will be tracked.

For disabling function with acknowledgement object...

- Activate the parameter "Use acknowledgement".
The acknowledgement object is available. The disabling function can only be deactivated using the acknowledgement object by an ON telegram. OFF telegrams to the disabling object or to the acknowledgement object are ignored by the actuator.
- Set the parameter "End of the disabling function after acknowledgement" to the required behaviour.

After an acknowledgement, the configured behaviour will be executed and the bus operation of the output enabled again.

no reaction: The relay of the output shows no reaction and remains in the position last set.

stop: At the end of the disabling function, the actuator switches the relays of the output to the "stop" position. A travel movement, if any, will be interrupted.

raising / opening: The actuator raises the blind or opens the venting louvre / roof window.

lowering / closing: The actuator lowers the blind/shutter or closes the venting louvre / roof window.

tracking the position: The last switching state received during the disabling function or the last position set before the disabling function (terminated travel movement) will be tracked.

- i** After a bus voltage failure or after programming the application or the parameters with the ETS, the disabling function is always deactivated (object value "0").
- i** Updates of the disabling object from "activated" to "deactivated" do not produce a reaction.
- i** The relay of a dimming channel disabled output via the KNX can still be operated manually.

Status message of the disabling function

- Activate the parameter "Status object".
The status object is available. The object sends a telegram with the value "1" if the disabling function is active. The object sends a telegram with the value "0" if the disabling function is inactive.

Setting forced position function

The forced position function can be enabled for each output. The forced position has the second highest priority after manual control. It therefore overrides the safety function, the sun protection function and the direct operation (short-time, long-time telegram, scenes, positioning, central). During a forced-position state, the output concerned is locked so that it can no longer be controlled with functions of a lower priority, but only with a manual control. At the end of a manual control, the forced-position action is re-executed if the forced position is still active.

The forced position function possesses a separate 2-bit communication object. The first bit (Bit 0) of the object "Forced position - Activate / Deactivate" indicates whether the Venetian blind output is raised or lowered under forced control. The second bit (bit 1) activates or deactivates the forced-position state (see table below).

The behaviour of a Venetian blind output at the end of the forced-position function can be configured. In addition, the forced object can be initialised on bus voltage return.

Bit 1	Bit 0	Function
0	x	Forced position not active -> normal control
1	0	Forced position active, raising / opening.
1	1	Forced position active: lowering / closing

Table 1: Bit coding of forced position

- i** The forced travel time required by an output to move the drive into the end positions is determined by the parameter "Travel time" on the parameter page "Relay outputs... -> VBO... - General -> Times". Like long time operation, a

forced-position movement is derived from the travel time.

Downward movement: movement time + 20%; Upward movement: movement time + 20% + configured movement time extension. Forced movements are not retriggerable.

i The slats of blinds are not repositioned at the end of forced movements into the end positions.

i Updates of the forced position object from "forced position active" to "forced position active" while maintaining the forced movement direction or from "forced position inactive" to "forced position inactive" show no reaction.

i After programming of the application or of the parameters with the ETS, the forced position is always cancelled.

i The current state of the forced position function will be stored in case of bus voltage failure.

- On the parameter page "Relay output... -> VBO... - General -> Enabled functions" Set the parameter "disabling function" to "forced position".

The forced position function is enabled. The communication object "Forced position - Activate / Deactivate" and the parameter of the forced position function on the parameter page "Relay output... -> VBO... - General -> Forced position" become visible.

- Set the parameter "End of the forced position" to the required behaviour.

At the end of the forced position, the configured behaviour will be executed and the bus control of the Venetian blind output enabled again.

tracking the position: At the end of a forced position function, the output will be set to the state adjusted statically before the forced position function or to the state tracked and internally stored during the forced position function. The position objects, the long-time object and the scene function are tracked.

no change: At the end of forced position function, the state last adjusted will not be changed. Thereafter, the output is again enabled. Any travel movements still in progress at this instant will still be finished.

i Parameter setting "tracking the position": The actuator can track absolute positions (position telegram, scene value) during activated forced control only if the position data are known and if positions have been predefined. If this is not the case, no reaction takes place at the time forced control is enabled. Position data can be tracked, if the output has been in a defined position before the forced position function or if a new position telegram has been received via the position objects while the forced position function was interlocked. In the latter case, a reference movement will be executed when the forced position function is enabled, if the position was unknown before or during the safety interlock. Known slat positions will also be tracked as described. This is also the case, when the height of the Venetian blind is unknown. Long time movements (movements without position preset) will, however, always be tracked.

- i The preset behaviour at the "end of the forced position function" will only be executed, if the output passes over to direct operation at the end of the forced position function. If a safety function or a sun protection function is activated (independent of the preset priority with respect to direct operation), the function with the next lower priority will be executed. The configured behaviour is not executed when the forced position is terminated by a specification on bus voltage return. The preset behaviour "After bus voltage return" will in this case be evaluated.

The forced position communication object can be initialised after bus voltage return. In this way, an output can be influenced and locked on bus initialisation when the forced position function is being activated.

- Set the parameter "After bus voltage return" to the required behaviour.

After bus voltage return, the configured state is transferred to the "Forced position - Activate / Deactivate" communication object. When a forced position is activated, the output is immediately activated and interlocked accordingly by forced control after bus voltage return until a forced position is enabled via the KNX. The parameter "After bus voltage return" on the parameter page "Relay output... - VBO... - General" is not evaluated for the affected output in this case.

no forced position active: The forced position is deactivated after bus voltage return. In this case, after bus voltage return the preset behaviour "After bus voltage return" on the parameter page "Relay outputs... - VBO... - General" will be executed.

Forced position function ON, raising or forced position function ON, opening: After bus voltage return, the forced position is activated and the blind raised or the venting louvre / roof window opened. The output concerned is interlocked by forced control until an enable signal is received via the KNX. The preset behaviour "After bus voltage return" on the parameter page "Relay outputs... - VBO... - General" is not evaluated for the affected output in this case.

Forced position function ON, lowering or forced position function ON, closing: After bus voltage return, the forced position is activated and the blind closed or the venting louvre / roof window closed. The output concerned is interlocked by forced control until an enable signal is received via the KNX. The preset behaviour "After bus voltage return" on the parameter page "Relay outputs... - VBO... - General" is not evaluated for the affected output in this case.

State of the forced position before bus voltage failure: The forced position state last selected and internally stored before bus voltage failure will be tracked after bus voltage return. An ETS programming operation deletes the stored state (reaction in that case same as with "no forced position active"). If the tracked state corresponds to "No forced position active", the behaviour "After bus voltage return" on the parameter page "Relay outputs... - VBO... - General" will be executed.

- i After programming the application or parameters with the ETS, the forced position function is always deactivated (object value "0").

11.11.1 Disabling function and forced position parameters

Relay outputs... -> VBO... - General -> Enabled functions

Disabling function / Forced position	no selection Disabling function forced position
It can be defined here whether a disabling function or a forced position for the Venetian blind output should be available. The disabling function is only configurable as an alternative to the forced position function.	

Relay outputs... -> VBO... - General -> Disabling function

Status object	Checkbox (yes / no)
The parameter determines whether the communication object "Disabling function - Status" is visible.	
Parameter activated: The status object is available. The object sends a telegram with the value "1" if the disabling function is active. The object sends a telegram with the value "0" if the disabling function is inactive.	
Parameter deactivated: No additional status object is available.	

Acknowledgement	Checkbox (yes / no)
The deactivation of the disabling function can optionally take place using an additional 1-bit acknowledgement object. This prevents the deactivation of the disabling function by the disabling object. Alternatively, the acknowledgement object is not available. In this case, disabling is deactivated via the disabling object.	
Parameter activated: The acknowledgement object is available. The disabling function can only be deactivated using the acknowledgement object by an ON telegram. OFF telegrams to the disabling object are ignored by the actuator.	
Parameter deactivated: No additional acknowledgement object is available. The disabling function can be deactivated via the disabling object by means of an "OFF" telegram.	

Beginning of the disabling function	No reaction stop raising lowering approach position
<p>The behaviour of the output at the beginning of the disabling function can be configured.</p> <p>This parameter is visible only if the disabling function is enabled.</p> <p>no reaction: The relay of the output shows no reaction and remains in the position last set.</p> <p>stop: At the beginning of the disabling function, the actuator switches the relays of the output to the "stop" position. A travel movement, if any, will be interrupted.</p> <p>raising: The actuator raises the blind/shutter.</p> <p>lowering: The actuator lowers the blind/shutter.</p> <p>approach position: At the beginning of the disabling function, the connected drive can approach a position (0...100%) specified by further parameters. If Venetian blinds are controlled with the device, the slats can be positioned independently. The actuator performs a reference movement before the position approach, because the current position at the time of the disabling function is unknown.</p> <p>This parameter is only available in the "Venetian blind with slat" and "shutter/awning" operating modes.</p>	

Beginning of the disabling function	No reaction stop open close approach position
<p>The behaviour of the output at the beginning of the disabling function can be configured.</p> <p>This parameter is visible only if the disabling function is enabled.</p> <p>no reaction: The relay of the output shows no reaction and remains in the position last set.</p> <p>stop: At the beginning of the disabling function, the actuator switches the relays of the output to the "stop" position. A travel movement, if any, will be interrupted.</p> <p>open: The actuator opens the venting louvre / roof window.</p> <p>close: The actuator closes the venting louvre / roof window.</p> <p>approach position: At the beginning of the disabling function, the connected drive can approach a position (0...100%) specified by further parameters. If Venetian blinds are controlled with the device, the slats can be positioned independently. The actuator performs a reference movement before the position approach, because the current position at the time of the disabling function is unknown.</p> <p>This parameter is only available in the "venting louvre / roof window" operating mode.</p>	
Venetian blind position (0...100%)	0...100
<p>This parameter sets the position value of the Venetian blind to be approached at the beginning of the disabling function.</p> <p>This parameter is only visible if the parameter "beginning of the disabling function" is set to "approach position".</p> <p>This parameter is only visible in the "Venetian blind with slat" operating mode.</p>	
Slat position (0...100%)	0...100
<p>This parameter sets the position value of the slat to be approached at the beginning of the disabling function and, as the case may be, after positioning of the Venetian blind.</p> <p>This parameter is only visible if the parameter "beginning of the disabling function" is set to "approach position".</p> <p>This parameter is only visible in the "Venetian blind with slat" operating mode.</p>	
Shutter/awning position (0...100%)	0...100
<p>This parameter sets the position value of the shutter or awning to be approached at the beginning of the disabling function.</p> <p>This parameter is only visible if the parameter "beginning of the disabling function" is set to "approach position".</p> <p>This parameter is only visible in the shutter/awning operating mode.</p>	

Venting louvre / roof window position (0...100%)	0...100
<p>This parameter sets the position value of the venting louvre or roof window to be approached at the beginning of the disabling function.</p> <p>This parameter is only visible if the parameter "beginning of the disabling function" is set to "approach position".</p> <p>This parameter is only visible in the "venting louvre / roof window" operating mode.</p>	
End of disabling function	No reaction stop raising lowering tracking the position
<p>The behaviour of the output at the end of the disabling function can be configured. This parameter is visible only if the disabling function is enabled and acknowledgement is not used.</p> <p>no reaction: The relay of the output shows no reaction and remains in the position last set.</p> <p>stop: At the end of the disabling function, the actuator switches the relays of the output to the "stop" position. A travel movement, if any, will be interrupted.</p> <p>raising: The actuator raises the blind/shutter.</p> <p>lowering: The actuator lowers the blind/shutter.</p> <p>tracking the position: The last switching state received during the disabling function or the last position set before the disabling function (terminated travel movement) will be tracked.</p> <p>This parameter is only available in the "Venetian blind with slat" and "shutter/awning" operating modes.</p>	

End of disabling function	No reaction stop open close tracking the position
<p>The behaviour of the output at the end of the disabling function can be configured. This parameter is visible only if the disabling function is enabled and acknowledgement is not used.</p> <p>no reaction: The relay of the output shows no reaction and remains in the position last set.</p> <p>stop: At the end of the disabling function, the actuator switches the relays of the output to the "stop" position. A travel movement, if any, will be interrupted.</p> <p>open: The actuator opens the venting louvre / roof window.</p> <p>close: The actuator closes the venting louvre / roof window.</p> <p>tracking the position: The last switching state received during the disabling function or the last position set before the disabling function (terminated travel movement) will be tracked.</p> <p>This parameter is only available in the "venting louvre / roof window" operating mode.</p>	
End of disabling function after acknowledgement	No reaction stop raising lowering tracking the position
<p>The behaviour of the output at the end of the disabling function can be configured. This parameter is visible only if the disabling function is enabled and acknowledgement is used.</p> <p>no reaction: The relay of the output shows no reaction on acknowledgement and remains in the position last set.</p> <p>stop: On acknowledgement, The actuator switches the relays of the output to the "stop" position. A travel movement, if any, will be interrupted.</p> <p>raising: The actuator raises the blind/shutter on acknowledgement.</p> <p>lowering: The actuator lowers the blind/shutter on acknowledgement.</p> <p>tracking the position: The last switching state received during the disabling function or the last position set on acknowledgement (terminated travel movement) will be tracked.</p> <p>This parameter is only available in the "Venetian blind with slat" and "shutter/awning" operating modes.</p>	

End of disabling function after acknowledgement	No reaction stop open close tracking the position
<p>The behaviour of the output at the end of the disabling function can be configured. This parameter is visible only if the disabling function is enabled and acknowledgement is used.</p> <p>no reaction: The relay of the output shows no reaction on acknowledgement and remains in the position last set.</p> <p>stop: On acknowledgement, The actuator switches the relays of the output to the "stop" position. A travel movement, if any, will be interrupted.</p> <p>open: The actuator opens the venting louvre / roof window on acknowledgement.</p> <p>close: The actuator closes the venting louvre / roof window on acknowledgement.</p> <p>tracking the position: The last switching state received during the disabling function or the last position set on acknowledgement (terminated travel movement) will be tracked.</p> <p>This parameter is only available in the "venting louvre / roof window" operating mode.</p>	

Relay outputs... -> VBO... - General -> Forced position

End of forced position	tracking the position No change
<p>At the end of the forced position, the configured behaviour will be executed and the bus control of the Venetian blind output enabled again. This parameter is only visible when the forced position function is enabled.</p> <p>tracking the position: At the end of a forced position function, the output will be set to the state adjusted statically before the forced position function or to the state tracked and internally stored during the forced position function. The position objects, the long-time object and the scene function are tracked.</p> <p>no change: At the end of forced position function, the state last adjusted will not be changed. Thereafter, the output is again enabled. Any travel movements still in progress at this instant will still be finished.</p>	

<p>After bus voltage return</p>	<p>no forced position active Forced position ON, raising Forced position ON, lowering State of forced position before bus voltage failure</p>
<p>After bus voltage return, the configured state is transferred to the "Forced position" communication object. When a forced position is activated, the output is immediately activated and interlocked accordingly by forced control after bus voltage return until a forced position is enabled via the KNX. The parameter "After bus voltage return" on the parameter page "Relay output... - VBO... - General" is not evaluated for the affected output in this case.</p> <p>This parameter is only visible when the forced position function is enabled.</p> <p>no forced position active: The forced position is deactivated after bus voltage return. In this case, after bus voltage return the preset behaviour "After bus voltage return" on the parameter page "Relay outputs... - VBO... - General" will be executed.</p> <p>Forced position ON, raising: After bus voltage return, the forced position is activated and the blind raised. The output concerned is interlocked by forced control until an enable signal is received via the KNX. The preset behaviour "After bus voltage return" on the parameter page "Relay outputs... - VBO... - General" is not evaluated for the affected output in this case.</p> <p>Forced position ON, lowering: After bus voltage return, the forced position is activated and the blind lowered. The output concerned is interlocked by forced control until an enable signal is received via the KNX. The preset behaviour "After bus voltage return" on the parameter page "Relay outputs... - VBO... - General" is not evaluated for the affected output in this case.</p> <p>State of the forced position before bus voltage failure: The forced position state last selected and internally stored before bus voltage failure will be tracked after bus voltage return. An ETS programming operation deletes the stored state (reaction in that case same as with "no forced position active"). If the tracked state corresponds to "No forced position active", the behaviour "After bus voltage return " on the parameter page "Relay outputs... - VBO... - General" will be executed.</p> <p>This parameter is only available in the "Venetian blind with slat" and "shutter/awning" operating modes.</p>	

<p>After bus voltage return</p>	<p>no forced position active Forced position ON, open Forced position ON, close State of forced position before bus voltage failure</p>
<p>After bus voltage return, the configured state is transferred to the "Forced position" communication object. When a forced position is activated, the output is immediately activated and interlocked accordingly by forced control after bus voltage return until a forced position is enabled via the KNX. The parameter "After bus voltage return" on the parameter page "Relay output... - VBO... - General" is not evaluated for the affected output in this case.</p> <p>This parameter is only visible when the forced position function is enabled.</p> <p>no forced position active: The forced position is deactivated after bus voltage return. In this case, after bus voltage return the preset behaviour "After bus voltage return" on the parameter page "Relay outputs... - VBO... - General" will be executed.</p> <p>Forced position function ON, opening: After bus voltage return, the forced position is activated and the venting louvre / roof window opened. The output concerned is interlocked by forced control until an enable signal is received via the KNX. The preset behaviour "After bus voltage return" on the parameter page "Relay outputs... - VBO... - General" is not evaluated for the affected output in this case.</p> <p>Forced position function ON, closing: After bus voltage return, the forced position is activated and the venting louvre / roof window closed. The output concerned is interlocked by forced control until an enable signal is received via the KNX. The preset behaviour "After bus voltage return" on the parameter page "Relay outputs... - VBO... - General" is not evaluated for the affected output in this case.</p> <p>State of the forced position before bus voltage failure: The forced position state last selected and internally stored before bus voltage failure will be tracked after bus voltage return. An ETS programming operation deletes the stored state (reaction in that case same as with "no forced position active"). If the tracked state corresponds to "No forced position active", the behaviour "After bus voltage return " on the parameter page Relay outputs... - VBO... - General" will be executed.</p> <p>This parameter is only available in the "venting louvre / roof window" operating mode.</p>	

11.11.2 Object list disabling function and forced position

Object no.	Function	Name	Type	DPT	Flag
25, 72...	Forced position - Activate / Deactivate	Venetian blind... - Input	2-bit	2.001	C, -, W, -, U
2-bit object for the forced position of a Venetian blind output. The polarity is fixed by the telegram.					
Object no.	Function	Name	Type	DPT	Flag
27, 74...	Disabling function - Activate / deactivate	Venetian blind... - Input	1-bit	1.003	C, -, W, -, U
1-bit object for disabling an active Venetian blind output ("1" = disabling function active, "0" = disabling function inactive).					
Object no.	Function	Name	Type	DPT	Flag
28, 75...	Disabling function - Acknowledgement	Venetian blind... - Input	1-bit	1.016	C, -, W, -, U
1-bit object to acknowledge an active disabling function of a Venetian blind output. This object is only visible if the acknowledgement is to be used with the disabling function ("1" = Disabling function is deactivated / "0" = disabling function remains active).					
Object no.	Function	Name	Type	DPT	Flag
55, 102 ...	Disabling function - Status	Venetian blind... - Output	1-bit	1.003	C, R, -, T, A
1-bit object to acknowledge an active disabling function of a Venetian blind output. This object is only visible if the acknowledgement is to be used with the disabling function ("1" = Disabling function is deactivated / "0" = disabling function remains active).					

12 Switching operation

12.1 Priorities

The actuator in switching operation distinguishes between different functions that can have an effect on an output. In order to prevent conflicting states, each available function has a certain priority. The function with the higher priority overrides the function with the lower priority.

For switching operation there are the following priorities...

- 1st priority: Manual control (highest priority),
- 2nd priority: Disabling function,
- 3th priority: Logical operation function & Staircase function,
- 4th priority: Direct bus operation ("switching" object, scenes, reset behaviour)

The behaviour of some functions can be configured at the end (e.g. the behaviour at the end of a manual operation or the behaviour at the end of the disabling function). These predefined reactions are only executed if the actuator can then immediately switch to direct operation (lowest priority).

If another function with a lower priority (e.g. manual operation) has been activated during a function with a high priority (e.g. disabling function), the actuator executes the behaviour at the beginning of the function with the next lower priority (e.g. disabling function). The behaviour at the end of the function with the higher priority (e.g. manual operation) is then not executed!

12.2 General settings

12.2.1 Reset behaviour

Delay after bus voltage return

To reduce telegram traffic on the KNX bus line after bus voltage activation (bus reset), after connection of the device to the bus line or after an ETS programming operation, it is possible to delay all actively transmitted status or feedback telegrams of the switching function. For this purpose, a channel-independent delay can be specified (parameter "Delay after bus voltage return" on the parameter page "General -> Switching outputs (SO)"). Only after the configured time elapses are feedback telegrams for initialisation transmitted to the KNX.

Which of the telegrams is actually delayed and which is not can be set for each switching output and for status function separately.

- i** The delay has no effect on the behaviour of the outputs. Only the bus telegrams for status or feedback are delayed. The outputs can also be activated during the delay after bus voltage return.
- i** A setting of "0" for the delay after bus voltage return deactivates the delaying function altogether. In this case, any messages, if actively transmitted, will be transmitted to the KNX without any delay.

12.2.1.1 Reset behaviour parameters

General -> Switching outputs (SO)

Delay after bus voltage return	0...59 min 0...17...59 s
To reduce telegram traffic on the KNX bus line after bus voltage activation (bus reset), after connection of the device to the KNX line or after an ETS programming operation, it is possible to delay all actively transmitted status or feedback telegrams of the switching function. For this purpose, a delay time can be defined here. Only after the configured time elapses are feedback telegrams for initialisation transmitted to the KNX.	

12.2.2 Name of a switching output

Here, you can optionally assign a name for each switching output. The name is intended to illustrate the use of the output (e.g. "light kitchen", "wall lamp living room"). The names are only used in the ETS in the text of the parameter pages and communication objects.

12.2.2.1 Parameter name

Relay outputs... -> SO... - General

Name of switching output	Free text
The text entered in this parameter is applied to the name of the communication objects and is used to label the switching output in the ETS parameter window (e.g. "light kitchen", "wall lamp living room"). The text is not programmed in the device.	

12.3 Operating mode

The relay of a switching output can be configured as NO or NC contacts. In this way, the inversion of switching states is possible.

The parameter "Operating mode" exists separately for each switching output on the parameter page "Relay outputs -> SO... - General".

- Set the operating mode to "NO contact".
The relay works as an NO contact. The logical switching state of the switching output is not forwarded to the relay in inverted form.
Switching state = OFF ("0") -> relay contact open,
Switching state = ON ("1") -> relay contact closed.
- Set the operating mode to "NC contact".
The relay works as an NC contact. The logical switching state of the switching output is forwarded to the relay in inverted form.
Switching state = OFF ("0") -> relay contact closed,
Switching state = ON ("1") -> relay contact open.
- i** The logic switching state "ON" or "OFF" is set by the communication object "Switching" and influenced by the functions that can be optionally activated (e.g. timing/staircase functions, logic operations, disabling functions, scenes).
- i** The 1-bit feedbacks always feed back the logical switching state of the switching outputs. Depending on the configured relay operating mode and an inverted or non-inverted evaluation, a status feedback has the following meanings:
NO contact not inverted: Feedback = "ON" -> Relay closed, feedback = "OFF" -> Relay opened
NO contact inverted: Feedback = "ON" -> Relay opened, feedback = "OFF" -> Relay closed
NC contact not inverted: Feedback = "ON" -> Relay opened, feedback = "OFF" -> Relay closed
NC contact inverted: Feedback = "ON" -> Relay closed, feedback = "OFF" -> Relay opened
- i** Feedback of the current switching status via the "switching" object is not possible.

12.3.1 Operating mode parameters

Relay outputs -> SO... - General

Operating mode	NO contact NC contact
<p>The relay of a switching output can be configured as NO or NC contacts. In this way, the inversion of switching states is possible.</p> <p>NO contact: Switching state = OFF ("0") -> Relay contact opened Switching state = ON ("1") -> Relay contact closed</p> <p>NC contact: Switching state = OFF ("0") -> Relay contact closed Switching state = ON ("1") -> Relay contact opened</p>	

12.3.2 Object list operating mode

Object no.	Function	Name	Type	DPT	Flag
598, 620 ...	Switching	Switching... - Input	1-bit	1.001	C, -, W, -, U
<p>1-bit input object to activate a switching output ("1" = Switch on / "0" = Switch off; "NO contact" or "NC contact" operating mode can be configured).</p>					

12.4 Reset and initialisation behaviour

Presetting the behaviour after ETS programming

The relay behaviour of the output after an ETS programming operation is permanently set to "no reaction". After ETS programming, the relay of the output shows no response and remains in the switching state last selected. The internal logical switching state is not lost by the ETS programming operation.

- i** A switching state set after an ETS programming operation is added to the feedback object. Actively transmitting feedback objects also only first transmit after an ETS programming cycle when the initialisation has finished and, if necessary, the "delay after bus voltage return" has elapsed.
- i** After an ETS programming operation, the disabling function is always deactivated.

Setting the behaviour in case of bus voltage failure

In case of bus voltage failure, the relay of the output shows no reaction and remains in the switching state last selected.

- i** Active disabling functions are cancelled by a bus voltage failure and remain inactive until they are reactivated after a bus voltage return.

Setting the behaviour after bus voltage return

The parameter "After bus voltage return" exists separately for each switching output on the parameter page "Relay outputs -> SO... - General".

- Set the parameter to "no reaction".
After bus voltage return, the relay of the output shows no reaction and remains in the switching state last selected.
- Set the parameter to "Close contact".
The relay contact is closed.
- i** A switching state set after bus voltage return is tracked in the feedback objects. Actively transmitting feedback objects first transmit, however, after bus voltage return, when the initialisation of the actuator has finished, and if necessary the "Delay after bus voltage return" has elapsed.
- i** In the case of enabling function as supplementary function: Active disabling functions are always inactive after bus voltage return.

12.4.1 Reset and initialisation behaviour parameter

Relay outputs -> SO... - General

After ETS programming operation	No reaction
The behaviour of the actuator after ETS programming is specified as a fixed value, and cannot be adjusted. The relay of the output shows no reaction and remains in the switching state last selected. The internal logical switching state is not lost by the ETS programming operation.	
In case of bus voltage failure	No reaction
The behaviour of the actuator is predefined in case of bus voltage failure. The relay of the output shows no reaction and remains in the switching state last selected.	
After bus voltage return	close contact no reaction
The actuator allows the reaction to be set separately for each switching output after bus voltage return. close contact: The relay contact is closed. no reaction: After bus voltage return, the relay of the output shows no reaction and remains in the switching state last selected.	

12.5 Feedback telegrams

The actuator can track the current switching state of a switching output via a feedback object and can also transmit them to the KNX. On each switching operation, the actuator determines the object value of the feedback. The actuator tracks the switching state and updates the feedback object even when a switching output, for example, is activated by a supplementary function or scene function.

The switching status feedback object is updated after the following events...

- Immediately after switch-on of a switching output (if necessary, first after a switch-on delay has elapsed / also after a staircase function).
- After switch-off of a switching output (if necessary, only after a switch-off delay has elapsed / also after a staircase function).
- During updating of the switching state from "ON" to "ON" or "OFF" to "OFF" when the switching output is already switched on or off. However, only if the parameter "Update of the object value" is configured to "On each update of object 'Switching'/'Central'".
- At the start or end of a disabling function, if a state changes as a result.
- Always on bus voltage return or at the end of any ETS programming process (if necessary, also delayed).

i In the case of enabling function as supplementary function: A "flashing" switching channel is always reported as "switched on".

In addition to switching status feedback, the actuator can also report back enlarged status information messages and transmit them actively to the KNX.

Particularly for simple connection to visualisations or for diagnoses, the actuator can also transmit various status information in combined data points. This can significantly reduce the telegram load. Two different types of data points are available. Both communication objects transmit in the case of a change of status.

Activate switching status feedback

The switching status feedback is also directly transmitted to the KNX whenever the feedback value is updated.

Optionally, the actuator can also feed back the status of an independent switching output in inverted form.

The parameter "Switching status" exists separately for each switching output on the parameter page "Relay outputs -> SO... - General -> Status". Feedback takes place via the "Switching - Status" object.

Precondition:

The feedback must be enabled on the parameter page "Relay outputs -> SO... - General -> Enabled functions".

- Activate the checkbox "Status object switching".

A switching status is transmitted as soon as it is updated. An automatic telegram transmission of the feedback takes place after bus voltage return or after programming with the ETS. The switching status is written to the object in non-inverted form.

- Optionally activate the checkbox "Invert".

A switching status is transmitted as soon as it is updated. An automatic telegram transmission of the feedback takes place after bus voltage return or after programming with the ETS. The switching status is written to the object in inverted form.

- Deactivate the checkbox "Status object switching".

The switching status feedback of the affected switching output is deactivated.

- i** Depending on the configured relay operating mode and an inverted or non-inverted evaluation, a status feedback has the following meanings:
- NO contact not inverted: Feedback = "ON" -> Relay closed, feedback = "OFF" -> Relay opened
- NO contact inverted: Feedback = "ON" -> Relay opened, feedback = "OFF" -> Relay closed
- NC contact not inverted: Feedback = "ON" -> Relay opened, feedback = "OFF" -> Relay closed
- NC contact inverted: Feedback = "ON" -> Relay closed, feedback = "OFF" -> Relay opened

- i** Feedback of the current switching status via the "switching" object is not possible.

Set update of "Switching feedback"

In the ETS, you can specify when the actuator should update the feedback value for the switching status (object "Switching - Status") in case of an actively transmitting communication object. The object value updated by the actuator is then signalled actively to the KNX.

The parameter "Update of the object value" can be preset separately for each switching output on the parameter page "Relay outputs -> SO... - General -> Status".

Precondition:

The feedback must be enabled on the parameter page "Relay outputs -> SO... - General -> Enabled functions". In addition, the switching status feedback must be configured to actively transmitting.

- Set the parameter to "after each update object 'Switching'/'Central'".

The actuator updates the feedback value in the object once a new telegram is received on the input objects "Switching" or "Central switching" or the switching state changes internally (e.g. through a time function). With an actively transmitting feedback object, a new telegram is also then actively transmitted to the KNX each time. The telegram value of the feedback does not necessar-

ily have to change in the process. Hence, a corresponding switching status feedback is also generated on the "Switching" object such as in the case of cyclical telegrams for example.

- Set the parameter to "Only if the feedback value changes".

The actuator only updates the feedback value in the object if the telegram value (e.g. "OFF" to "ON") also changes or the switching state changes internally (e.g. through a time function). If the telegram value of the feedback does not change (e.g. in the case of cyclical telegrams to the "Switching" object with the same telegram value), the actuator does not transmit any feedback. Consequently, with an actively transmitting feedback object, no telegram with the same content will be transmitted repeatedly either.

This setting is recommendable, for instance, if the "Switching" and "Switching feedback" objects are linked to an identical group address. This is often the case when activating by means of light scene push-button sensors (recall and storage function).

Setting switching status feedback on bus voltage return or after programming with the ETS

If used as active message object, the switching status feedback states are transmitted to the KNX after bus voltage return or after programming with the ETS. In these cases, the feedback telegram can be time-delayed, with the delay being preset globally for all switching outputs together.

- Activate the parameter "Delay after bus voltage return" on the parameter page "Relay outputs -> SO... - General -> Status".

The switching status telegram is transmitted with a delay after bus voltage return or after an ETS programming operation. No feedback telegram is transmitted during a running delay, even if the switching state changes during this delay.

- Deactivate the parameter.

The switching status telegram is transmitted immediately after bus voltage return or after an ETS programming operation.

Setting cyclical transmission of the switching status feedback telegram

The switching status feedback telegrams can, if actively transmitting, also be transmitted cyclically, in addition to the transmission after updating.

- Activate the parameter "Cyclical transmission" on the parameter page "Relay outputs -> SO... - General -> Status".

Cyclical transmission is activated. The cycle time for the switching status feedback can be configured separately for the parameter "Time for cyclical transmission".

- Deactivate the parameter.

Cyclical transmission is deactivated so that the feedback is transmitted to the KNX only when updated by the actuator.

Activating feedback of the combined function status

Particularly for simple connection to visualisations or for diagnoses, the actuator can also transmit various status information in combined data points. This can significantly reduce the telegram load. Two different types of data points are available. Both communication objects transmit in the case of a change of status.

The feedback of the combined function status can be enabled and programmed independently for each output.

The feedback functions of an output must be enabled on the parameter page "Relay outputs -> SO... - General -> Enabled functions". Only then are the parameters for the feedback visible on the parameter page "Relay outputs -> SO... - General -> Status".

- Activate the checkbox "Function status (KNX standard)".

The standardised feedback object is enabled. In addition to the current brightness value (for the switch actuator either 0% or 100%), it contains various bit-coded status information. A telegram is transmitted as soon as there is a change.

The feedback functions of an output must be enabled on the parameter page "Relay outputs -> VBO... - General -> Enabled functions". Only then are the parameters for the feedback visible on the parameter page "Relay outputs -> SO... - General -> Status".

- Activate the checkbox "Function status (KNX extended)".

The feedback object is enabled. It contains various bit-coded status information and an enumeration of the various statuses with higher priorities. A telegram is transmitted as soon as there is a change.

12.5.1 Feedback telegrams parameter

Relay outputs -> SO... - General -> Enabled functions

Status	Checkbox (yes / no)
This parameter can be used to disable or to enable the feedback functions.	

Relay outputs -> SO... - General -> Status

switching status	Checkbox (active/inactive)
<p>The current switching state of the switching output can be reported separately back to the KNX.</p> <p>inactive: The switching status feedback of the affected switching channel is deactivated.</p> <p>active: A switching status is transmitted as soon as it is updated. An automatic telegram transmission of the feedback takes place after bus voltage return or after programming with the ETS.</p>	

Invert	Checkbox (active/inactive)
<p>The current switching state of the switching output can be reported separately back to the KNX.</p> <p>inactive: The switching status is written to the object in non-inverted form.</p> <p>active: The switching status is written to the object in inverted form.</p>	

Updating of the object value	after each update object "Switching"/"Central" only if the feedback value changes
<p>Here, you can specify when the actuator should update the feedback value for the switching status (object "Switching feedback") in case of an actively transmitting communication object. The object value updated by the actuator is then signalled actively to the KNX.</p> <p>This parameter is only visible with feedback activated.</p> <p>after each update object "Switching"/"Central": The actuator updates the feedback value in the object once a new telegram is received on the input objects "Switching" or "Central switching" or the switching state changes internally (e.g. through a time function). With an actively transmitting feedback object, a new telegram is also then actively transmitted to the KNX each time. The telegram value of the feedback does not necessarily have to change in the process. Hence, a corresponding switching status feedback is also generated on the "Switching" object such as in the case of cyclical telegrams for example.</p> <p>only if the feedback value changes: The actuator only updates the feedback value in the object if the telegram value (e.g. "OFF" to "ON") also changes or the switching state changes internally (e.g. through a time function). If the telegram value of the feedback does not change (e.g. in the case of cyclical telegrams to the "Switching" object with the same telegram value), the actuator does not transmit any feedback. Consequently, with an actively transmitting feedback object, no telegram with the same content will be transmitted repeatedly either.</p>	

Delay after bus voltage return	Checkbox (yes / no)
<p>The states of the switching status feedback can be transmitted to the KNX with a delay after bus voltage return or after an ETS programming operation. The activated parameter causes a delay on bus voltage return. The delay time is configured for all outputs on the parameter page "General -> Switching outputs (SO)".</p> <p>This parameter is only visible with feedback activated.</p>	
Cyclical transmission	Checkbox (yes / no)
<p>The switching status feedback telegrams can, if actively transmitting, also be transmitted cyclically, in addition to the transmission after updating.</p> <p>This parameter is only visible with feedback activated.</p> <p>Parameter activated: Cyclical transmission is activated.</p> <p>Parameter deactivated: Cyclical transmission is deactivated so that the feedback is transmitted to the KNX only when updated by the actuator.</p>	
Time for cyclical transmission	0...23 h 0...2...59 min 0...59 s
<p>This parameter defines the time for the cyclical transmission of the switching status feedback.</p> <p>This parameter is only available if cyclical transmission is activated.</p>	
Function state (KNX standard)	Checkbox (active/inactive)
<p>The actuator can report a combined function status to the KNX via a 2-byte communication object with the data point type 207,600 (DPT_StatusLightingActuator). This includes the brightness value and bit-coded status information.</p> <p>active: Feedback and the object are activated. A telegram is sent each time an individual status changes.</p> <p>inactive: There is no feedback object available for the output. feedback deactivated</p>	
Function state (extended)	Checkbox (active/inactive)
<p>The actuator can report a combined function status to the KNX via a 3-byte communication object with a non-standardised data point type. This includes bit-coded status information and an enumeration of the possible statuses that can disable direct operation due to a higher priority.</p> <p>active: Feedback and the object are activated. A telegram is sent each time an individual status changes.</p> <p>inactive: There is no feedback object available for the output. feedback deactivated</p>	

12.5.2 Feedback object list

Object no.	Function	Name	Type	DPT	Flag
599, 621 ...	Switching - Status	Switching... - Output	1-bit	1.001	C, R, -, T, A
<p>1-bit object for feedback signalling of a switching state of a switching output ("1" = on / "0" = off) to the bus.</p> <p>Depending on the configured relay operating mode, the feedback value should be interpreted differently:</p> <p>NO contact operating mode: Feedback = "0" -> Relay open, feedback = "1" -> Relay closed</p> <p>NC contact operating mode: Feedback = "0" -> Relay closed, feedback = "1" -> Relay opened</p>					

Object no.	Function	Name	Type	DPT	Flag
615, 637 ...	Function state (KNX standard)	Switching... - Output	2-byte	207.60 0	C, R, -, T, A
<p>The following states are signalled to the KNX using this 2-byte output object:</p> <p>Byte 1 (bit 8 ... Bit 15): Brightness value in percent (switched on = 100%, switched off = 0%)</p> <p>Bit 7: Error (always "0", the object "Heartbeat" is used for evaluating the device status)</p> <p>Bit 6: Output has been overridden by manual operation. The bit remains active as long as the status set by the manual operation is active.</p> <p>Bit 5: Dimming process active (always "0")</p> <p>Bit 4: Staircase function active</p> <p>Bit 3: Night operation active (always "0")</p> <p>Bit 2: Restraint active</p> <p>Bit 1: Disabling function active</p> <p>Bit 0: Brightness value (byte 1) valid</p> <p>An application-orientated filter of the displayed messages can be performed by appropriate KNX devices or visualisation solutions.</p>					

Object no.	Function	Name	Type	DPT	Flag
616, 638 ...	Function state (extended)	Switching... - Output	3-byte		C, R, -, T, A
<p>The following states are signalled to the KNX using this 3-byte output object:</p> <p>Bit 23 ... Bit 9: Reserved (always "0")</p> <p>Bit 8: Staircase function active (any active pre-warning times are not displayed here)</p> <p>Bit 7: Switch-off delay active</p> <p>Bit 6: Switch-on delay active</p> <p>Bit 5: ... Bit 0: Enumeration of various statuses with higher priority (in the case of multiple active statuses, the one with the highest priority is output)</p> <p>The following statuses (numerical values) are defined for the lower-value 6 bits:</p> <p>0: No disabling active</p> <p>1: Permanent manual operation active</p> <p>2: Restraint active</p> <p>3: Disabling function without acknowledgement active</p> <p>4: Disabling function with acknowledgement active</p> <p>5 ... 63: Not used</p> <p>An application-orientated filter of the displayed messages can be performed by appropriate KNX devices or visualisation solutions.</p>					

12.6 Time delays

Up to two time functions can be preset for each switching output, independently of each other. The time functions affect the communication objects "Switching" or "Central switching" only (if at least one of the central functions is activated for the output concerned) and delay the object value received depending on the telegram polarity.

- i** At the end of a disabling function, the switching state received during the function or set before the function can be tracked. At the same time, residual times of time functions are also tracked if these had not yet fully elapsed at the time of the reactivation.
- i** The time delays do not influence the staircase function if this is enabled.
- i** A time delay still in progress will be fully aborted by a reset of the actuator (bus voltage failure or ETS programming).

Activating switch-on delay

The switch-on delay can be activated separately in the ETS for each switching output.

Precondition:

The time delays must be enabled on the parameter page "Relay outputs -> SO... - General -> Enabled functions".

- Activate the checkbox "switch-on delay". Configure the desired switch-on delay.

The switch-on delay is enabled. After receipt of an ON telegram via the "switching" or "central switching" object, the configurable time is started. Another ON-telegram triggers the time only when the parameter "Switch-on delay retriggerable" is activated. An OFF-telegram received during the ON-delay will end the delay and sets the switching status to "OFF".

Activating switch-off delay

The switch-off delay can be activated separately in the ETS for each switching output.

Precondition:

The time delays must be enabled on the parameter page "Relay outputs -> SO... - General -> Enabled functions".

- Activate the checkbox "switch-off delay". Configure the desired switch-off delay.

The switch-off delay is enabled. After reception of an OFF telegram via the "switching" or "central switching" object, the configurable time is started. Another OFF-telegram triggers the time only when the parameter "switch-off delay retriggerable" is activated. An ON-telegram received during the OFF-delay will end the delay and sets the switching status to "ON".

12.6.1 Time delays parameters

Relay outputs -> SO... - General -> Enabled functions

Time delays	Checkbox (yes / no)
This parameter can be used to disable or to enable the time delays. The parameter is deactivated if cyclical monitoring is enabled.	

Relay outputs -> SO... - General -> Time delays

Switch-on delay	Checkbox (yes / no)
The communication objects "Switching" or "Central switching" can be evaluated after a time delay. This parameter enables the switch-on delay and thereby activates the necessary parameters.	

Delay time	0...59 min 0...10...59 s
This parameter is used for setting the duration of the switch-on delay.	

Switch-on delay retriggerable	Checkbox (yes / no)
A switch-on delay still in progress can be retriggered by another "ON" telegram (parameter activated). Alternatively, the retriggering time (parameter deactivated) can be suppressed. This parameter is only visible if switch-on delay is activated.	

Switch-off delay	Checkbox (yes / no)
The communication objects "Switching" or "Central switching" can be evaluated after a time delay. This parameter enables the switch-off delay and thereby activates the necessary parameters.	

Delay time	0...59 min 0...10...59 s
This parameter is used for setting the duration of the switch-off delay.	

Switch-off delay retriggerable	Checkbox (yes / no)
A switch-off delay still in progress can be retriggered (parameter activated) by another "OFF" telegram. Alternatively, the retriggering time (parameter deactivated) can be suppressed. This parameter is only visible if switch-off delay is activated.	

12.7 Staircase function

The staircase function can be used for implementing time-controlled lighting of a staircase or for function-related applications. The staircase function must be enabled in the ETS on the parameter page "Relay outputs -> SO... - General -> Enabled functions", in order for the required communication objects and parameters to be visible.

The staircase function is activated via the communication object "Staircase function Start/Stop" and is independent of the "switching" object of a switching output. In this way, parallel operation of time and normal control is possible, whereby the command last received is always executed: A telegram to the "switching" object or a scene recall at the time of an active staircase function aborts the staircase time prematurely and presets the switching state according to the received object value (the time delays are also taken into account) or scene value. Likewise, the switching state of the "switching" object can be overridden by a staircase function.

Time-independent continuous light switching can also be implemented in combination with a disabling function because the disabling function has a higher priority and overrides the switching state of the staircase function.

Furthermore, an extension of the staircase function can be implemented by means of a separate switch-on delay and pre-warning function. The pre-warning should, according to DIN 18015-2, warn any person still on the staircase that the light will soon be switched off.

Specifying switch-on behaviour of the staircase function

An ON telegram to the "Staircase function - Start/Stop" object activates the staircase time (T_{ON}), the duration of which is defined by the "Staircase time" parameters. In addition, a switch-on delay (T_{Delay}) can be activated (see "presetting switch-on delay of the staircase function"). At the end of the staircase time, the output switches off or activates optionally the pre-warning time ($T_{Prewarn}$) of the pre-warning function (see "presetting pre-warning function of the staircase function"). Taking into account any possible switch-on delay and pre-warning function, this gives rise to the switch-on behaviour of the staircase function as shown in the following diagram.

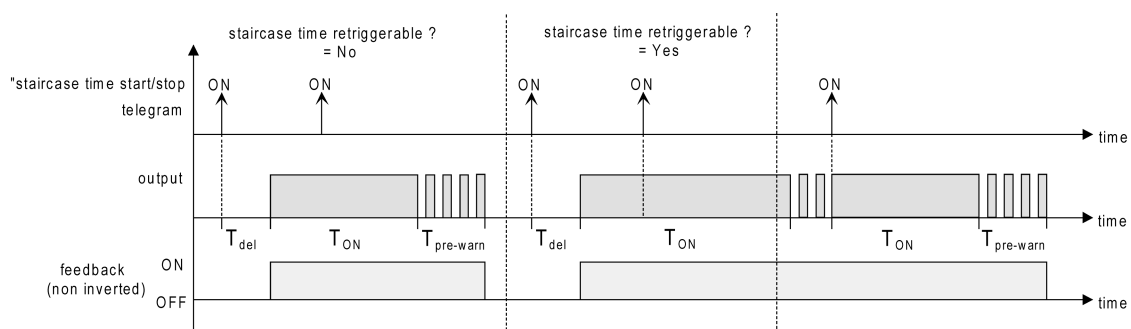

Image 17: Switch-on behaviour of the staircase function

The parameter "Retriggerable" specifies whether the staircase time can be retriggered.

Precondition:

The staircase function must be enabled on the parameter page "Relay outputs -> SO... - General -> Enabled functions".

- Activate the parameter "Retriggerable".

Every ON telegram received during the ON phase of the staircase time retriggerers the staircase time completely.

- Deactivate the parameter "Retriggerable".

ON telegrams received during the ON phase of the staircase time are rejected. The staircase time is not retriggered.

- i** An ON telegram received during the pre-warning time always retriggerers the staircase time independently of the parameter "Retriggerable".

Specifying switch-off behaviour of the staircase function

In the case of a staircase function, the reaction to an OFF telegram can also be configured to the object "Staircase function - Start/Stop". Without the receipt of an OFF telegram the output switches off after the pre-warning time elapses, if necessary. Taking into account any possible switch-on delay and pre-warning function, this gives rise to the switch-off behaviour of the staircase function as shown in the following diagram.

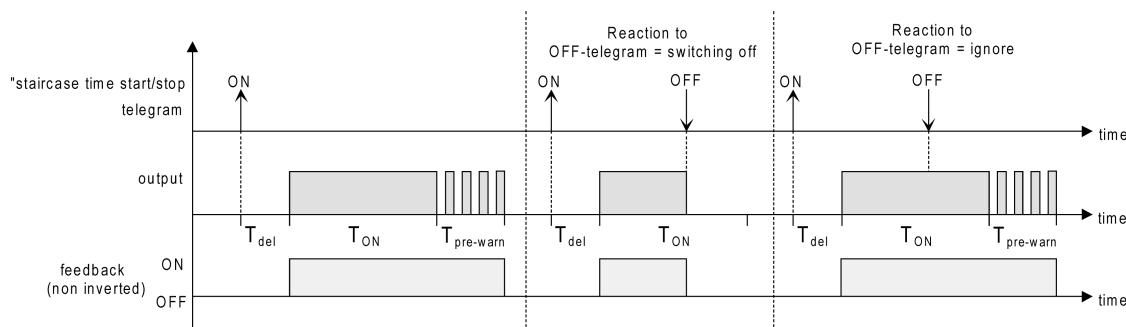

Image 18: Switch-off behaviour of the staircase function

The parameter "reaction to OFF-telegram" defines whether the staircase time (T_{ON}) of the staircase function can be aborted prematurely.

Precondition:

The staircase function must be enabled on the parameter page "Relay outputs -> SO... - General -> Enabled functions".

- Set parameter "Reaction to OFF-telegram" to "switch off".

As soon as an OFF telegram is received via the object "Staircase function - Start/Stop" during the ON phase of the staircase time, the output switches off immediately. If the staircase time is stopped prematurely by such a telegram, there is no pre-warning, i.e. the pre-warning time is not started.

- Set parameter "Reaction to OFF-telegram" to ignore".

OFF telegrams received during the ON phase of the staircase time are rejected. The staircase time will be executed completely to the end with pre-warning if necessary.

- i** The parameter "Reaction to OFF telegram" does not influence the reception and the evaluation of OFF telegrams via the "Switching" object.

Setting the switch-on delay of the staircase function

An ON telegram for activation of the staircase function can also be evaluated with a time delay. This switch-on delay can be activated separately for the staircase function and has no influence on the configurable time delays for the object "switching".

Precondition:

The staircase function must be enabled on the parameter page "Relay outputs -> SO... - General -> Enabled functions".

- On the parameter page "Relay outputs -> SO... - General -> Staircase function" deactivate the parameter "Switch-on delay".
The switch-on delay is deactivated. After receipt of an ON telegram on the object "Staircase function - Start/Stop", the staircase time is activated immediately and the output switched on.
 - Activate the parameter "switch-on delay".
The switch-on delay for the staircase function is enabled. The desired switch-on delay time can be specified. After receipt of an ON telegram on the object "Staircase function - Start/Stop", the switch-on delay is started. Another ON-telegram triggers the time only when the parameter "Switch-on delay retriggerable" is activated. The staircase time is activated and the output is switched on only after the time delay has elapsed.
- i** An OFF telegram via the object "Staircase function - Start/Stop" during the switch-on delay only terminates the delay if the parameter "Reaction to OFF-telegram" is set to "switch off". Otherwise, the OFF telegram is ignored.

Setting the pre-warning function of the staircase function

The pre-warning should, according to DIN 18015-2, warn persons still on the staircase that the light will soon be switched off. The lighting connected on the output is briefly switched off repeatedly as a pre-warning, before the output is switched off permanently. At the same time, the pre-warning time (T_{Prewarn}), the duration of the interruptions during the pre-warning ($T_{\text{Interrupt}}$) and the number of pre-warning interruptions are configurable (see figure 19). The pre-warning time is added to the staircase time (T_{ON}). The pre-warning time influences the value of the feedback object so that the value "OFF" (in the case of non-inverted transmission) is first tracked after the pre-warning time in the object has elapsed.

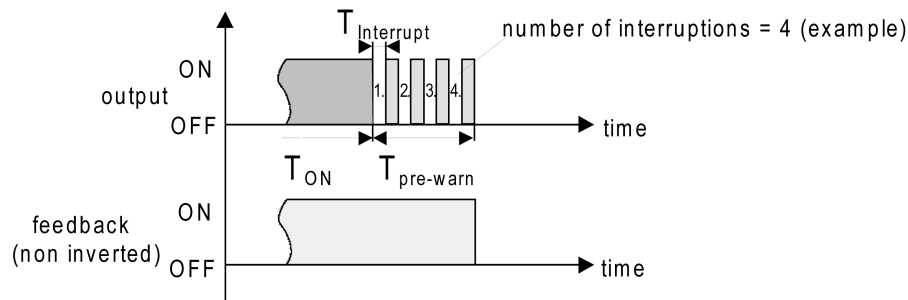

Image 19: The pre-warning function of the staircase function (example)

Precondition:

The staircase function must be enabled on the parameter page "Relay outputs -> SO... - General -> Enabled functions".

- On the parameter page "Relay outputs -> SO... - General -> Staircase function" set the parameter "At the end of the staircase time" to "activate pre-warning time".

The pre-warning function is enabled. The desired pre-warning time (T_{Prewarn}) can be preset.

- Set the parameter "Number of pre-warnings" to the desired value (1...10).
Within the pre-warning time, the lighting connected on the output is switched off just as often as configured here. The 1st pre-warning is always executed at the beginning of the entire pre-warning time.
- Set the parameters "Time for pre-warning interruptions" to the desired value.
An interruption ($T_{\text{Interrupt}}$) during the pre-warning time is just as long as configured here. The adjustable interruption time allows the switch-off phase of the lighting to be adapted individually to the lamps used.

- i** It should be noted that the "number of pre-warnings" and the "time for pre-warning interruptions" must be attuned to the duration of the entire "pre-warning time". Hence, the entire switch-off phase during a pre-warning ("number of pre-warnings" + "time for pre-warning interruptions") must not be set longer than the pre-warning time! Otherwise, malfunctions can be expected.
- i** An ON telegram to the object "Staircase function - Start/Stop" while a pre-warning function is still in progress stops the pre-warning time and always restarts the staircase time (independently of the parameter "Staircase time re-triggerable"). Even during the pre-warning time, the parameter "reaction to OFF telegram" is evaluated so that a pre-warning in progress can be terminated early by switching off.

12.7.1 Staircase function parameters

Relay outputs -> SO... - General -> Enabled functions

Staircase function	Checkbox (yes / no)
This parameter can be used to disable or to enable the staircase function. The parameter is deactivated if cyclical monitoring is enabled.	

Relay outputs -> SO... - General -> Staircase function

Staircase time	0...23 h 0...3...59 min 0...59 s
The duration of the switch-on time for the staircase function is configured here.	

retriggerable	Checkbox (yes / no)
An active switch-on time can be retriggered (parameter activated). Alternatively, the retriggering time (parameter deactivated) can be suppressed. This parameter is preset to deactivated if the supplementary function "Time extension" is configured. Re-triggering will not be possible.	

Switch-on delay	Checkbox (yes / no)
The staircase function enables the activation of an own switch-on delay. This switch-on delay affects the trigger result of the staircase function and thus delays the switch-on. activated: The switch-on delay for the staircase function is enabled. After receipt of an ON telegram on the object "Staircase function start/stop", the switch-on delay is started. Another ON-telegram triggers the time only when the parameter "Switch-on delay retriggerable" is activated. The staircase time is activated and the output is switched on only after the time delay has elapsed. deactivated: The switch-on delay is deactivated. After receipt of an ON telegram on the object "Staircase function start/stop", the staircase time is activated immediately and the output switched on.	

Switch-on delay	0...23 h 0...59 min 0...30...59 s
This parameter is used for setting the duration of the switch-on delay.	

retriggerable	Checkbox (yes / no)
An active switch-on delay can be retriggered (parameter activated). Alternatively, the retriggering time (parameter deactivated) can be suppressed. This parameter is deactivated if the supplementary function "Time extension" is configured. Re-triggering will not be possible. The parameters for the switch-on delay are only visible when the switch-on delay is used.	

Reaction to OFF-telegram	switch off ignore
<p>An active switch-on time can be aborted prematurely by switching off the staircase function.</p> <p>switch off: The switch-on time is aborted after receipt of an OFF telegram on the object "Staircase time start/stop".</p> <p>With the supplementary function "time preset via the bus" and the setting "Staircase function activatable via object 'Staircase time' = activated" the switch-on time can also be prematurely ended by a factor of "0".</p> <p>ignore: OFF Telegrams or "0" factors are ignored. The switch-on time will be executed completely to the end.</p>	
At the end of staircase time	switch off activate pre-warning time
<p>At the end of the staircase time, the actuator for the switching output concerned displays the configured behaviour here. The output can be set to switch off immediately or alternatively to execute a pre-warning function.</p> <p>switch off: At the end of the staircase time, the actuator switches off the switching output concerned.</p> <p>Activate pre-warning time: At the end of the staircase time, the switching output can generate a pre-warning prior to switching off. The pre-warning, for example, should warn any person still on the staircase that the light will soon be switched off.</p>	
Pre-warning time	0...59 min 0... 30 ...59 s
<p>This parameter is used for setting the duration of the pre-warning time. The pre-warning time is added to the switch-on time.</p>	
Time for pre-warning interruptions	0...59 s 0... 500 ...900 ms
<p>This parameter defines the duration of a pre-warning interruption, i.e. how long the switching output is to remain off during a pre-warning interruption. The time should be customized individually to the switch-off behaviour of the lamp used.</p>	
Number of pre-warnings	1... 3 ..10
<p>This parameter defines how often the switching output is to switch off within the pre-warning time. i.e. how many pre-warnings will be generated.</p>	

12.7.2 Object list staircase function

Object no.	Function	Name	Type	DPT	Flag
608, 630 ...	Staircase function - Start/Stop	Switching... - Input	1-bit	1.010	C, -, W, -, U
1-bit object to activate or deactivate the switch-on time of the staircase function of a switching output ("1" = switch-on / "0" = switch-off).					

12.8 Scene function

Up to 16 scenes can be programmed and scene values stored separately for each switching output. The scene values are recalled or stored via a separate scene extension object. The data point type of the extension object permits addressing of all scenes.

The scene function must be enabled on the parameter page "Relay outputs -> SO... - General -> Enabled functions" for each switching output, in order for the required communication objects and parameters (on the parameter page "Relay outputs -> SO... - General -> Scenes") to become visible.

The number of scenes used can be selected anywhere in the range 1 to 16. The parameter "Number of scenes" decides how many scenes are visible for the switching output in the ETS and can therefore be used. It is possible to specify which scene number (1 ... 64) controls each scene.

The scene function can be combined together with other functions of a switching output, whereby the last received or preset state is always executed:

Telegrams to the "Switching" objects, a scene recall or scene storage telegram at the time of an active staircase function aborts the staircase time prematurely and presets the brightness state according to the received object value (time delays are also taken into account) or scene value.

Similarly, the state of the switching output, which was preset by the "Switching", "Dimming" or "Brightness value" objects or by a scene recall, can be overridden by a staircase function.

Presetting a scene recall delay

Each scene recall of a switching output can optionally also be delayed. With this feature, dynamic scene sequences can be configured if several scene outputs are combined with cyclical scene telegrams.

Precondition

The scene function must be enabled on the parameter page "Relay outputs -> SO... - General -> Enabled functions".

- On the parameter page "Relay outputs -> SO... - General -> Scenes" activate the parameter "Delay scene recall".

The delay time is now activated and can be configured separately. The delay only influences the scene recall of the switching output. The delay time is started on arrival of a recall telegram. The corresponding scene will be recalled and the switching channel set to the switching state value only after this time has elapsed.

- i** Each scene recall telegram restarts the delay time and retriggers it. If a new scene recall telegram is received while a delay is active (scene recall not yet executed), the old (and not yet recalled scene) will be rejected and only the scene last received executed.

- i** The scene recall delay has no influence on the storage of scene values. A scene storage telegram within a scene recall delay terminates the delay and thus the scene recall.

Presetting the behaviour during ETS programming

When a scene is saved, the switching states are saved permanently in the device. To prevent the stored values from being replaced during ETS programming of the application or parameters by the originally programmed scene switching states, the actuator can inhibit overwriting of the switching states. As an alternative, the original values can be reloaded into the device during each programming run of the ETS.

Precondition

The scene function must be enabled on the parameter page "Relay outputs -> SO... - General -> Enabled functions".

- On the parameter page "Relay outputs -> SO... - General -> Scenes", activate the parameter "Overwrite values stored in the device during the ETS programming operation".

During each ETS programming operation of the application or of the parameters, the scene switching states configured in the ETS for the switching output concerned will be programmed into the actuator. Scene switching states stored in the device by means of a storage function will be overwritten, if any.

- Deactivate the parameter "Overwrite values stored in the device during the ETS programming operation".

Scene switching states stored in the device with a storage function will be maintained. If no scene switching states have been stored, the switching states last programmed in the ETS remain valid.

- i** When the actuator is commissioned for the first time, this parameter should be activated so that the switching output is initialised with valid scene switching states.

Setting scene numbers and scene switching states

The scene number (1...64) with which the scene is addressed, i.e. recalled or stored, must be determined for each internal scene of the switching output. The data point type of the scene extension object permits addressing of all scenes.

In addition to specifying the scene number, it is necessary to define which scene command (ON, OFF) should be set on the switching output during a scene recall.

Precondition

The scene function must be enabled on the parameter page "Relay outputs -> SO... - General -> Enabled functions".

- On the parameter page "Relay outputs -> SO... - General -> Scenes", set the parameter for each scene to the numbers with which the scenes are to be addressed.

A scene can be addressed with the configured scene number. A setting of "0" deactivates the corresponding scene so that neither recalling nor storage is possible.

- i** If the same scene number is configured for several scenes, only the scene with the lowest sequential number will be addressed. The other scenes will be ignored in this case.
- On the parameter page "Relay outputs -> SO... - General -> Scenes" set the parameter "Switching state for each scene to the desired switching command. During a scene recall, the configured switching state is recalled and set on the switching output.
- i** The configured switching state is adopted in the actuator during programming with the ETS only if the parameter "Overwrite values stored in the device during ETS download" is activated.

Presetting storage behaviour

The switching state set for the switching output can be stored internally via the extension object on reception of a scene storage telegram. In this case, the switching state can be influenced before the storage by all functions of the switching output provided that the individual functions have been enabled (e.g. also the disabling function, etc.).

Precondition

The scene function must be enabled on the parameter page "Relay outputs -> SO... - General -> Enabled functions".

- On the parameter page "Relay outputs -> SO... - General -> Scenes" activate the parameter "storage function" for each scene.
The storage function is activated for the scene in question. On receipt of a storage telegram via the "Extension" object, the current switching state will be stored internally.
- Deactivate the parameter "storage function" for each scene.
The storage function is deactivated for the scene in question. A storage telegram received via the "Extension" object will be rejected.

Optionally, a visual feedback via the switching output can be signalled when executing a storage command. The channel flashes once as feedback in the configured flashing time. This enables the system operator to determine locally whether the desired scene switching state has been saved correctly in the actuator. A switching state feedback on the KNX is not generated.

- On the parameter page "Relay outputs -> SO... - General -> Scenes" activate the parameter "visual feedback for storage function". In the parameter "Flashing time", set the time in which the visual feedback is to be executed.
When a storage function is executed, the visual feedback is activated immediately. The output switches to the opposite switching state for the duration of the configured flashing time and then back to the saved scene command.

- Deactivate the parameter "visual feedback for storage function".
When storing a scene, the visual feedback is not executed. The actuator adopts the current switching state of the output without special feedback.
- i** The visual feedback is only executed if no other function with a higher priority (e.g. disabling function) is active in the moment when the memory function is active.

12.8.1 Scene function parameters

Relay outputs -> SO... - General -> Enabled functions

Scene function	Checkbox (yes / no)
This parameter can be used disable or to enable the scene function. The parameter is deactivated if cyclical monitoring is enabled.	

Relay outputs -> SO... - General: -> Scenes

Delay scene recall	Checkbox (yes / no)
A scene is recalled via the scene extension object. If required, the scene recall can be delayed on reception of a recall telegram (parameter activated). The recall is alternatively made immediately on reception of the telegram (parameter deactivated).	

Delay time	0...59 min 0...10...59 s
This parameter specifies the length of the scene delay time.	

Visual feedback for storage function	Checkbox (yes / no)
Optionally, a visual feedback via the switching output can be signalled when executing a storage command. The channel flashes once as feedback in the configured flashing time. Parameter activated: When a storage function is executed, the visual feedback is activated immediately. The output switches to the opposite switching state for the duration of the configured flashing time and then back to the saved scene command. Parameter deactivated: When storing a scene, the visual feedback is not executed. The actuator adopts the current switching state of the output without special feedback.	

Flashing time	0...5...10 s
The flashing time in which the visual feedback is to be executed is set here. This parameter is only visible when visual feedback is used.	

Overwrite values stored in the device during the ETS programming operation	Checkbox (yes / no)
During storage of a scene, the scene values (current states of the switching outputs concerned) are stored internally in the device. To prevent the stored values from being replaced during ETS programming by the originally programmed scene values, the actuator can inhibit overwriting of the scene values (parameter deactivated). As an alternative, the original values can be reloaded into the device during each programming run of the ETS (parameter activated).	

Number of scenes	1...10...16
This parameter is only available with variable scene configuration and defines how many scenes are visible for the switching output in the ETS and can therefore be used.	

Scene number	0...1*...64 *: The predefined scene number is dependent on the scene (1...64).
<p>The number of scenes used can be selected anywhere in the range 1 to 64. It is then possible to preset which scene number (1 ... 64) controls each scene. A setting of "0" deactivates the corresponding scene so that neither recalling nor storage is possible. If the same scene number is configured for several scenes, only the scene with the lowest sequential number will be addressed. The other scenes will be ignored in this case.</p>	
Switching state	ON OFF
<p>This parameter is used for configuring the switching state which is set when the scene is recalled.</p>	
Memory function	Checkbox (yes / no)
<p>If the parameter is activated, the storage function of the scene is enabled. The current switching state can then be stored internally via the extension object on receipt of a storage telegram. If the parameter is deactivated, the storage telegrams are rejected.</p>	

12.8.2 Object list scene function

Object no.	Function	Name	Type	DPT	Flag
604, 626...	Scenes - Extension	Switching... - Input	1-byte	18.001	C, -, W, -, U
1-byte object for polling or saving a scene.					

12.9 Disabling function and forced position

A disabling function, or alternatively, a forced position function can be configured for each switching output. In this respect, only one of these functions can be enabled for one switching output.

Presetting disabling function

During an active disabling function, the KNX operation of the switching output concerned is overridden and locked. Continuous light switching, for example, can also be overridden. The deactivation of the disabling function can optionally take place using an additional 1-bit acknowledgement object. This prevents the deactivation of the disabling function by the disabling object.

- On the parameter page "Relay outputs -> SO... - General -> Enabled functions" Set the parameter "disabling function / forced position" to "disabling function".

The disabling function is enabled. The communication object "Disabling function - Activate / deactivate" and the parameters of the disabling function on the parameter page "Relay outputs -> SO... - General -> Disabling function" become visible.

- Set the parameter "Object polarity" to the desired polarity.
- Set the parameter "Beginning of the disabling function" to the required behaviour.

At the beginning of the disabling function, the configured behaviour will be executed and bus operation of the switching output locked.

When the setting "No change of switching state" is selected, the relay of the output shows no reaction and remains in the switching state last set (switching state in acc. with last non-inverted feedback telegram).

In the "Flashing" setting, the switching output is switched on and off cyclically during the disabling. The "Time for flashing of the disabling functions" is configured individually for each switching output. During flashing, the logical switching state of the switching output is fed back as "Switched on".

For disabling function without acknowledgement object...

- Deactivate the checkbox "Acknowledgement".

No additional acknowledgement object is available. The disabling function is deactivated by the disabling object according to the set polarity.

- Set the parameter "End of the disabling function" to the required behaviour.

At the end of the disabling function, the configured behaviour will be executed and the bus operation of the switching output enabled again.

In the "No change of switching state" setting, the relay of the output shows no reaction and remains in the state last set by the disabling function.

In "Set tracked state", the last switching state received during the disabling function or the switching state set before the disabling function will be tracked. Any time functions still in progress will also be taken into account if necessary.

In the "Flashing" setting, the switching output is switched on and off cyclically after the disabling. The "Time for flashing of the disabling functions" is configured individually for each switching output. During flashing, the logical switching state of the output is fed back as "Switched on". The flashing state remains active until another KNX command is received and thereby predefines another switching state.

For disabling function with acknowledgement object...

- Activate the checkbox "Use acknowledgement".

The acknowledgement object is available. The disabling function can only be deactivated using the acknowledgement object by an ON telegram. Telegrams to the disabling object according to the "Deactivate disabling" polarity are ignored by the actuator.

i "OFF" telegrams to the acknowledgement object do not product a reaction.

- Set the parameter "End of the disabling function after acknowledgement" to the required behaviour.

After an acknowledgement, the configured behaviour will be executed and the bus operation of the switching output enabled again.

In the "No change of switching state" setting, the relay of the output shows no reaction and remains in the state last set by the disabling function.

On acknowledgement in "Set tracked state", the last switching state received during the disabling function or the switching state set before the disabling function will be tracked. Any time functions still in progress will also be taken into account if necessary.

In the "Flashing" setting, the switching output is switched on and off cyclically after the acknowledgement. The "Time for flashing of the disabling functions" is configured individually for each switching output. During flashing, the logical switching state of the output is fed back as "Switched on". The flashing state remains active until another KNX command is received and thereby predefines another switching state.

i After a bus voltage failure or after programming the application or the parameters with the ETS, the disabling function is always deactivated (object value "0"). With the inverted setting "1 = enabled; 0 = disabled", a telegram update "0" must first be carried out after the initialisation until the disabling is activated.

i Updates of the disabling object from "activated" to "deactivated" do not produce a reaction.

i The relay of a switching output disabled via the KNX can still be operated manually.

- i** In the setting "Set tracked state": During a disabling function, the overridden functions of the actuator (switching, scenes) continue to be executed internally. Consequently, newly received bus telegrams are evaluated and time functions are triggered as well. At the end of the disabling, the tracked states are set.

Setting forced position function

The forced position function can also be combined with other functions of a switching output. With an active forced position, functions with a lower priority are overridden so that the switching output concerned is locked.

The forced position function possesses a separate 2-bit communication object. The first bit (Bit 0) of the object "Forced position" indicates whether the switching output is switched off or switched on by force. The second bit (bit 1) activates or deactivates the forced-position state (see table below).

The behaviour of a switching output at the end of the forced position can be configured. In addition, the forced object can be initialised on bus voltage return.

Bit 1	Bit 0	Function
0	x	Forced position not active -> normal control
1	0	Forced position active: switch off
1	1	Forced position active: switch on

Table 2: Bit coding of forced position

- On the parameter page "Relay outputs -> SO... - General -> Enabled functions" Set the parameter "disabling function" to "forced position".
The forced position function is enabled. The communication object "Forced position" and the parameters of the forced position function on the parameter page "Relay outputs -> SO... - General -> Forced position" become visible.
 - Set the parameter "forced position end 'inactive'" to the required behaviour.
At the end of the forced position, the configured behaviour will be executed and the bus operation of the switching output enabled again.

In the "No change of switching state" setting, the relay of the output shows no reaction and remains in the state last set by the forced position.

In the "Track switching state", the state received during the forced position function or the switching state set before the function can be tracked at the end of the forced position. Any time functions still in progress will also be taken into account if necessary.
- i** Updates of the forced position object from "Forced position active" to "Forced position active" while maintaining the switching status or from "Forced position inactive" to "Forced position inactive" show no reaction.
- i** A switching output forcibly activated via the KNX can be still be operated manually!

- i** In the setting "Track switching state" at the end of the forced position: During a forced position, the overridden functions of the actuator (switching, scenes) continue to be executed internally. Consequently, newly received bus telegrams are evaluated and time functions are triggered as well. At the forced end, the tracked states are set.
- i** The current state of the forced position object will be stored in case of bus voltage failure.

 - Set the parameter "After bus voltage return" to the required behaviour.
After bus voltage return, the configured state is transferred to the "Forced position" communication object. When a forced position is activated, the switching output is immediately activated and interlocked accordingly by forced control after bus voltage return until a forced position is enabled via the KNX. The parameter "After bus voltage return" on the parameter page "Relay outputs - SO... - General" is not evaluated for the affected switching output in this case.

In the "state before bus voltage failure" setting, the forced position state last selected and internally stored before bus voltage failure will be tracked after bus voltage return. An ETS programming operation deletes the stored state (reaction in that case same as with "no forced position active").

If the tracked state corresponds to "No forced position", the force-independent parameter "After bus voltage return" (parameter page "Relay outputs - SO... - General") will be executed on return of bus voltage.
- i** After programming the application or parameters with the ETS, the forced position function is always deactivated (object value "0").

12.9.1 Disabling function and forced position parameters

Relay outputs -> SO... - General -> Enabled functions

Disabling function / Forced position	no selection Disabling function forced position
It can be defined here whether a disabling function or a forced position for the switching output should be available. The disabling function is only configurable as an alternative to the forced position function.	

Relay outputs -> SO... - General -> Disabling function

Time for flashing the disabling functions	1 s 2 s 5 s 10 s
Switching outputs can flash in the disabled state (cyclical switching on and off). The flashing time for the switching output is configured here.	

Status object	Checkbox (yes / no)
If disabling is active, the switching output can transmit the status via a 1-bit communication object. Parameter activated: The status object is available. When the disabling function is activated, it sends a telegram with the value "1" ("=enabled"). When the disabling function is deactivated, it sends a telegram with the value "0" ("=not enabled"). Parameter deactivated: No additional status object is available.	

Acknowledgement	Checkbox (yes / no)
The deactivation of the disabling function can optionally take place using an additional 1-bit acknowledgement object. This prevents the deactivation of the disabling function by the disabling object. Alternatively, the acknowledgement object is not available. In this case, disabling is deactivated via the disabling object. Parameter activated: The acknowledgement object is available. The disabling function can only be deactivated using the acknowledgement object by an ON telegram. Telegrams to the disabling object according to the "Deactivate disabling" polarity are ignored by the actuator. Parameter deactivated: No additional acknowledgement object is available. The disabling function is deactivated by the disabling object according to the set polarity.	

Polarity of the disabling object	0 = disabled; 1 = enabled 1 = enabled; 0 = disabled
This parameter defines the polarity of the disabling object. This parameter is visible only if the disabling function is enabled.	

Beginning of the disabling function	no change to the switching state Switch off Switch on Flashing
<p>The behaviour of the switching output at the beginning of the disabling function can be configured.</p> <p>This parameter is visible only if the disabling function is enabled.</p> <p>no change of switching state: The relay of the output shows no reaction and remains in the switching state last set (switching state in acc. with last non-inverted feedback telegram).</p> <p>Switch off: At the beginning of the disabling function, the switching output is switched off and locked.</p> <p>Switch on: At the beginning of the disabling function, the switching output is switched on and locked.</p> <p>Flash: The switching output is switched on and off cyclically during the disabling. The "Time for flashing" is generally configured on the parameter page "Switching outputs (SO)". During flashing, the logical switching state of the switching output is fed back as "Switched on".</p>	
End of disabling function	no change to the switching state Switch off Switch on set tracked state Flashing
<p>The behaviour of the switching output at the end of the disabling function can be configured.</p> <p>This parameter is visible only if the disabling function is enabled and acknowledgement is not used.</p> <p>no change of switching state: The relay of the output shows no reaction and remains in the state last set by the disabling function.</p> <p>Switch off: At the end of the disabling function, the switching output is switched off and enabled again.</p> <p>Switch on: At the end of the disabling function, the switching output is switched on and enabled again.</p> <p>Set tracked state: The last switching state received during the disabling function or the switching state set before the disabling function will be tracked. Any time functions still in progress will also be taken into account if necessary.</p> <p>Flash: The switching output is switched on and off cyclically after the disabling. The flashing time is configured generally on the parameter page "General -> Switching outputs (SO)". During flashing, the logical switching state of the output is fed back as "Switched on". The flashing state remains active until another KNX command is received and thereby predefines another switching state.</p>	

End of disabling function after acknowledgement	no change to the switching state Switch off Switch on set tracked state Flashing
<p>The behaviour of the switching output at the end of the disabling function after acknowledgement can be configured.</p> <p>This parameter is visible only if the disabling function is enabled and acknowledgement is used.</p> <p>no change of switching state: The relay of the output shows no reaction on acknowledgement and remains in the state last set by the disabling function.</p> <p>Switch off: On acknowledgement, the switching output is switched off and enabled again.</p> <p>Switch on: On acknowledgement, the switching output is switched on and enabled again.</p> <p>Set tracked state: On acknowledgement, the last switching state received during the disabling function or the switching state set before the disabling function will be tracked. Any time functions still in progress will also be taken into account if necessary.</p> <p>Flash: The switching output is switched on and off cyclically after the acknowledgement. The flashing time is configured generally on the parameter page "General -> Switching outputs (SO)". During flashing, the logical switching state of the output is fed back as "Switched on". The flashing state remains active until another KNX command is received and thereby predefines another switching state.</p>	

Relay outputs -> SO... - General -> Forced position

Forced position "active, switch on"	Switch on
<p>If the forced position is activated and restraint is "ON", the switching output is always switched on.</p> <p>This parameter cannot be edited and is only visible when the forced position function is enabled.</p>	
Forced position "active, switch off"	Switch off
<p>If the forced position is activated and restraint is "OFF", the switching output is always switched off.</p> <p>This parameter cannot be edited and is only visible when the forced position function is enabled.</p>	

Forced position end "inactive"	<p>tracking the switching state no change to the switching state Switch off Switch on</p>
--------------------------------	---

The behaviour of the switching output at the end of the forced-position can be configured here.

This parameter is only visible when the forced position function is enabled.

Track switching state: The state received during the forced position function or the switching state set before the function can be tracked at the end of the forced position. Any time functions still in progress will also be taken into account if necessary.

No change of switching state: The relay of the output shows no reaction and remains in the state last set by the forced position.

Switch off: At the end of the forced position, the switching output is switched off and enabled again.

Switch on: At the end of the forced position, the switching output is switched on and enabled again.

After bus voltage return	<p>no forced position Forced position active, switch on Forced position active, switch off state before bus voltage failure</p>
--------------------------	---

The forced position communication object can be initialised after bus voltage return. The switching state of the output can be influenced when the forced position function is being activated.

This parameter is only visible when the forced position function is enabled.

No forced position: The force-independent parameter "After bus voltage return" (parameter page "Relay outputs -> SO... - General") will be executed on return of bus voltage.

Forced position active, switch on: The forced position is activated. The switching output is switched on under forced control.

Forced position active, switch off: The forced position is activated. The switching output is switched off under forced control.

State before bus voltage failure: The forced position state last selected and internally stored before bus voltage failure will be tracked after bus voltage return. An ETS programming operation deletes the stored state (reaction in that case same as with "no forced position active"). If the tracked state corresponds to "No forced position", the force-independent parameter "After bus voltage return" (parameter page "Relay outputs -> SO... - General") will be executed on return of bus voltage.

12.9.2 Object list disabling function and forced position

Object no.	Function	Name	Type	DPT	Flag
606, 628 ...	Disabling function - Activate / deactivate	Switching... - Input	1-bit	1.003	C, -, W, -, U
1-bit object for disabling a switching output (polarity configurable).					
Object no.	Function	Name	Type	DPT	Flag
614, 636 ...	Disabling function - Acknowledgement	Switching... - Input	1-bit	1.016	C, -, W, -, U
1-bit object to acknowledge an active disabling function of a switching output. This object is only visible if the acknowledgement is to be used with the disabling function ("1" = Disabling function is deactivated / "0" = disabling function remains active).					
Object no.	Function	Name	Type	DPT	Flag
617, 639 ...	Disabling function - Status	Switching... - Output	1-bit	1.003	C, R, -, T, A
1-bit object to acknowledge an active disabling function of a switching output. This object is only visible if the acknowledgement is to be used with the disabling function ("1" = Disabling function is deactivated / "0" = disabling function remains active).					
Object no.	Function	Name	Type	DPT	Flag
607, 629 ...	Forced position - Activate / Deactivate	Switching... - Input	2-bit	2.001	C, -, W, -, U
2-bit object for the forced position of a switching output. The polarity is fixed by the telegram.					

12.10 Logic operation function

A logic function can be configured separately for each switching output. This function allows the logic operation of the "Switching" object state and an additional logic operation object. The state of the communication object for "switching" can also be evaluated with a time delay if a switch-on delay or switch-off delay is set.

The logic function can also be combined with other functions of a switching output. A combination with the staircase function is not possible, however.

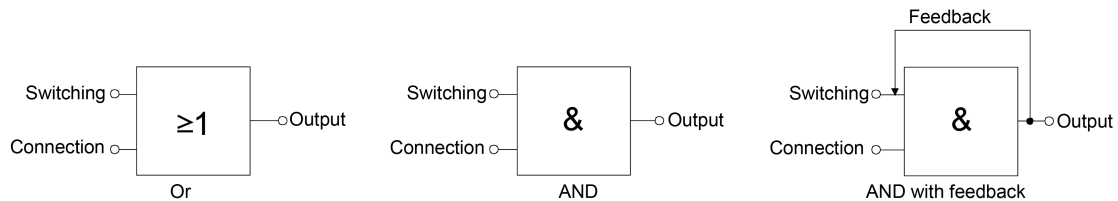

Image 20: Logic operation types of the logic operation function

- i** "AND with feedback":
 With a logic object = "0", the switching output is always "0" (logic AND). In this case, the feedback signal from the output to the "switching" input will directly reset this input when it is being set. The output of the switching output can assume the logical state "1" by a newly received "1" on the input "switching" only when the logic object is = "1".

The object "Logic operation" can be initialised with a configured value after bus voltage return or after an ETS programming operation so that a correct logic operation result can be determined immediately and set on the output of the switching output during a telegram update on the "Switching" object.

- On the parameter page "Relay outputs -> SO... - General -> Enabled functions" activate the "logic operation function".
 The logic operation function is enabled. The communication object "Logic operation function - Input" and the parameters of the logic operation function on the parameter page "Relay outputs -> SO... - General -> Logic operation function" become visible.
- Set the parameter "Type of logic operation function" to the desired logic operation type.
- Set the parameters "object value after bus voltage return" and "object value after ETS programming" to the required initial states.

The "Logic operation - Input" object is initialised immediately with the set switching states after bus voltage return or ETS programming of the application program or parameters.

- i** The logic operation function after a reset of the actuator (bus voltage return or ETS programming operation) is first executed when the switching object is updated as the input of the logic operation by at least one telegram.

- i** The states or switching states specified at the end of a disabling function, which are set after programming in the ETS, in the case of bus voltage failure or after bus or mains voltage return, override the logic operation function. The

configured logic operation is first re-executed and the result set on the switching output when the switching object is updated as the input of the logic operation by at least one telegram.

12.10.1 Logic operation function parameters

Relay outputs -> SO... - General -> Enabled functions

Logic operation function	Checkbox (yes / no)
The logic operation function can be enabled here. The parameter is deactivated and unchangeable if the staircase function is enabled.	

Relay outputs -> SO... - General -> Logic operation function

Type of logic operation function	OR AND AND with feedback
This parameter defines the logical type of the logic operation function. The object "Logic operation - Input" is linked to the logic switching state of the switching output (object "Switching" after evaluation of any configured time delays) on the basis of the logic operation function set here. This parameter is only visible when the logic operation function is enabled.	

Object value after bus voltage return	0 (OFF) 1 (ON)
After bus voltage return, the object value of the logic operation object is initialised here with the preset value. This parameter is only visible when the logic operation function is enabled.	

Object value after ETS download	0 (OFF) 1 (ON)
After programming the application or the parameters in the ETS, the object value of the logic operation object is initialised here with the preset value. This parameter is only visible when the logic operation function is enabled.	

12.10.2 Object list logic operation function

Object no.	Function	Name	Type	DPT	Flag
600, 622...	Logic operation function - Input	Switching... - Input	1-bit	1.002	C, -, W, -, U

1-bit object as input of the logical link of an switching output. After bus voltage return or after programming with the ETS, the object value can be predefined by means of a parameter.

13 As-delivered state

In the as-delivered state, the actuator is passive, i.e. no telegrams are transmitted to the KNX. All relay outputs are set to Venetian blind operation. The outputs can, however, be activated by manual operation on the device, if the bus voltage is on. With manual operation, no feedback telegrams are sent to the KNX.

The device can be programmed and put into operation via the ETS. The physical address is preset to 15.15.255.

Moreover the device has been configured at the factory with the following characteristics...

- Travel time (continuous run): 1 minute, 0 seconds extended by 20%
- Movement time extension: 2%
- Break during movement direction changeover: 1 s
- Behaviour in case of bus voltage failure: Stop
- Behaviour in case of bus voltage return: Stop
- Status indication: permanent

i The as-delivered state cannot be restored by unloading the application program with the aid of the ETS. When the application program is removed, all the outputs remain permanently switched off. The manual operation remains without function in this case.

i In the as-delivered state, the relays are switched to the "stop" state when the bus voltage is applied in order to initialise the relays. This short switching operation can be perceived acoustically.

Gira
Giersiepen GmbH & Co. KG
Elektro-Installations-
Systeme

Industriegebiet Mermbach
Dahlienstraße
42477 Radevormwald

Postfach 12 20
42461 Radevormwald

Deutschland

Tel +49(0)21 95 - 602-0
Fax +49(0)21 95 - 602-191

www.gira.de
info@gira.de