

Switching actuator / blind actuator 16 A Komfort Order no. 5033 00, 5038 00, 5040 00

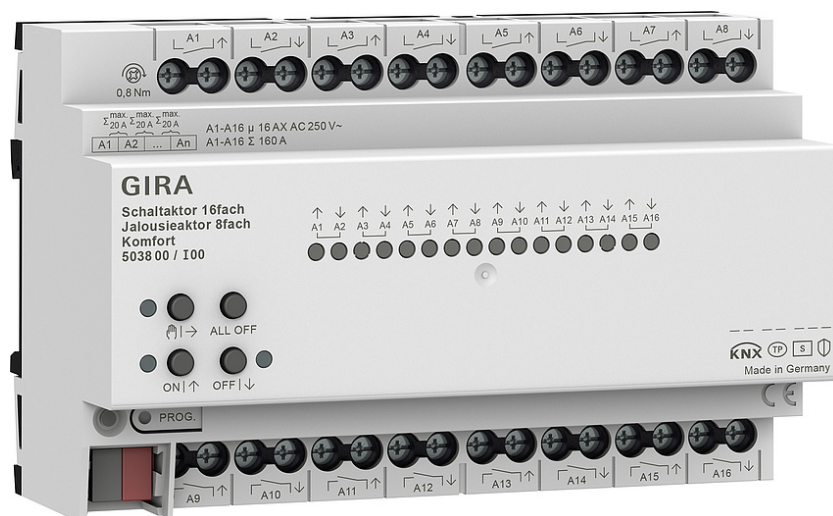

Table of Contents

1	Information on the product	5
1.1	Product catalogue	5
1.2	Function	5
1.3	Device components	7
1.4	Technical data.....	8
2	Safety instructions	10
3	Fitting and electrical connection	11
4	Commissioning	13
5	Application programs	15
6	Scope of functions	16
7	Notes on software	18
8	Operation and indication	19
8.1	Button operation and indication functions	19
8.2	ETS-Configuration	23
8.2.1	Manual operation	23
8.2.2	Status indication	26
8.3	Operation and indication parameter.....	28
9	Channel configuration	32
10	shutter/blinds operation	34
10.1	Priorities	34
10.2	General settings.....	35
10.2.1	Reset behaviour	35
10.2.2	Central functions.....	35
10.2.3	Safety functions	40
10.2.4	Name of a Venetian blind output	46
10.3	Operating mode	47
10.3.1	Operating mode parameter	48
10.4	Reset and initialisation behaviour	49
10.4.1	Reset and initialisation behaviour parameter	52
10.5	Short-time / Long-time operation, travelling times	54
10.5.1	Short-time / Long-time operation	54
10.5.2	Setting the travel time	55
10.5.3	Setting slat travel times (with slatted Venetian blinds)	58
10.5.4	Presetting the travel time extension and switchover time.....	59

10.5.5	Short-time / Long-time operation, travel times parameter	61
10.5.6	Object list Short-time / Long-time operation, travel times	64
10.6	Position calculation, position presetting and feedbacks	65
10.6.1	Position calculation and position presetting	65
10.6.2	Feedback telegrams	72
10.6.3	Parameter position calculation, position presetting and feedbacks	79
10.6.4	Object list position calculation, position presetting and feedbacks	84
10.7	Safety functions	85
10.7.1	Safety functions parameter	89
10.7.2	Object list safety functions	92
10.8	Sun protection function	93
10.8.1	Automatic heating/cooling	119
10.8.2	Sun protection function parameter	126
10.8.3	Object sun protection function	147
10.9	Scene function	149
10.9.1	Parameter scene function	153
10.9.2	Object list scene function	156
10.10	Disabling function and forced position	157
10.10.1	Parameter disabling function and forced position	162
10.10.2	Object list disabling function and forced position	170
10.11	Supplementary function	171
10.11.1	Parameter Supplementary functions	176
10.11.2	Object list supplementary function	179
11	Switching operation	180
11.1	Priorities	180
11.2	General settings	181
11.2.1	Reset behaviour	181
11.2.2	Central functions	182
11.2.3	Collective feedback	186
11.2.4	Name of a switching output	193
11.3	Operating mode	194
11.3.1	Operating mode parameter	195
11.3.2	Object list operating mode	195
11.4	Reset and initialisation behaviour	196
11.4.1	Reset and initialisation behaviour parameter	199
11.5	Cyclical monitoring	201
11.5.1	Parameter for cyclical monitoring	202
11.6	Feedback switching status	203

11.6.1	Parameter feedback switching status	207
11.6.2	Object list feedback switching status	210
11.7	Time delays.....	211
11.7.1	Parameter time delays.....	212
11.8	Staircase function	213
11.8.1	Parameter Staircase function	220
11.8.2	Object list staircase function.....	224
11.9	Scene function	225
11.9.1	Parameter scene function.....	230
11.9.2	Object list scene function.....	233
11.10	Disabling function and forced position	234
11.10.1	Parameter disabling function and forced position.....	238
11.10.2	Object list disabling function and forced position.....	242
11.11	Logic operation function.....	243
11.11.1	Parameter logic operation function	245
11.11.2	Object list logic operation function	246
11.12	Operating hours counter	247
11.12.1	Parameter Operating hours counter	252
11.12.2	Object list operating hours counter	255
12	Logic functions	257
12.1	Parameter logic functions	258
12.2	Logic gates.....	260
12.2.1	Logic gate parameter.....	262
12.2.2	Object list logic gate	265
12.3	Converter (1 bit -> 1 byte).....	267
12.3.1	Parameter converter	268
12.3.2	Object list converter	270
12.4	Disabling element [Filtering/Time].....	271
12.4.1	Parameter disabling element.....	273
12.4.2	Object list disabling element.....	277
12.5	Comparator.....	278
12.5.1	Parameter Comparator	280
12.5.2	Object list comparator.....	286
12.6	Limit value switch.....	289
12.6.1	Parameter limit value switch	291
12.6.2	Object list limit value switch	297
13	Delivery state	300

1 Information on the product

1.1 Product catalogue

Product name: Switching actuator / blind actuator 16 A Komfort

Use: Actuator

Design: RMD

Order no. 5033 00, 5038 00, 5040 00

1.2 Function

The switch/blind actuator receives telegrams from sensors or other controls via the KNX and switches electrical loads. The relay outputs of the actuator can be set in the ETS either to Venetian blind operation (2 relay outputs per channel) or alternatively (1 relay output per channel) to switching operation; mixed operation of these two operating modes is also possible on the device.

In Venetian blind operation the actuator can be used with its relay contacts to control electrically driven Venetian blinds, shutters, awnings, roof windows, venting louvers or similar blinds/shutters that are suitable for mains voltage. Alternatively, the actuator in switching operation switches electrical loads, such as lighting systems or door openers.

Each relay output has bus-powered bistable switching relays, which allows defined preferred positions in the event of bus voltage failure/recovery and after an ETS programming operation.

The buttons on the front panel of the device permit switching the relays on and off by hand in parallel during KNX operation or activated in a non-programmed state. This feature permits fast checking of connected loads for proper functioning.

The functionalities that can be preset in the ETS in Venetian blind operation include, for instance, independently parameterisable travel times, extended feedback functions, assignment to up to 5 different safety functions, an extensive sun protection function, and incorporation into scenes, disabling functions or forced-position applications. Centralized control of all Venetian blind outputs of up to 6 central functions is also possible.

In switching operation the functionalities NC contact or NO contact include, for example, extensive time functions, logic operations, scenes, monitoring functions, operating hours counters, disabling functions or alternatively forced positions. In addition, the switching status of a relay output can be signaled back. The central switching operation of all switching outputs of up to 6 central functions is possible, too.

In addition to the Venetian blind or switching operation, the device has 8 internal logic functions. Using these functions, logic gates (e.g. AND, OR, exclusive OR, each with up to 4 inputs) can be set up and thus switching and status information can be linked and evaluated. Alternatively, a 1-bit to 1-byte converter and a disabling element with filter and time functions can be configured for each logic function. As a further option,

comparators or limit value switches with hysteresis can be set as a logic function. The logic functions have their own KNX communication objects and can process telegrams of the actuator or of other bus devices.

The device can be updated. Firmware can be easily updated with the Gira ETS Service App (additional software).

The device is KNX Data Secure capable. KNX Data Secure offers protection against manipulation in building automation and can be configured in the ETS project. Detailed specialist knowledge is required. A device certificate, which is attached to the device, is required for safe commissioning. During mounting, it is recommended to remove the certificate from the device and to store it securely.

Planning, installation and commissioning of the device are carried out with the aid of the ETS, version 5.7.3 and above or of the ETS6.

The device electronics are supplied exclusively from the bus voltage. The device is designed for mounting on DIN-rails in closed compact boxes or in power distributors in fixed installations in dry rooms.

1.3 Device components

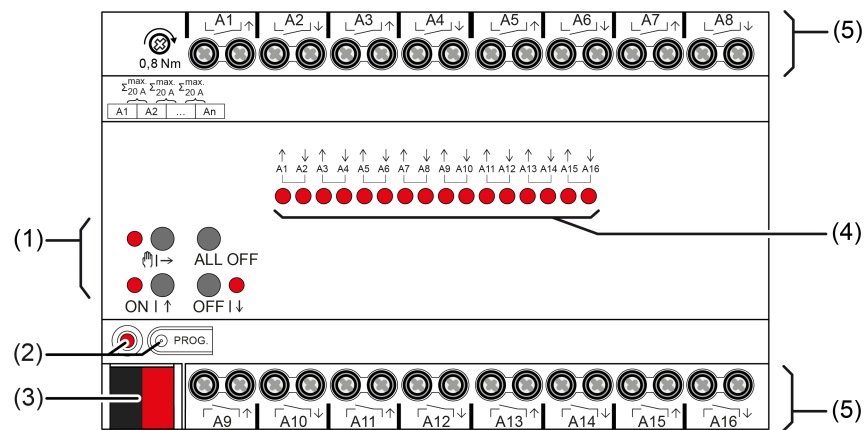

Image 1: Device components

- (1) Button field for manual operation
- (2) Programming button and LED
- (3) KNX connection
- (4) Status LEDs for outputs
- (5) Load connections (relay outputs)

1.4 Technical data

Ambient conditions	
Ambient temperature	-5 ... +45 °C
Storage/transport temperature	-25 ... +70 °C
KNX	
KNX medium	TP256
Commissioning mode	S-mode
Rated voltage KNX	DC 21 ... 32 V SELV
Current consumption KNX	
Order no. 5033 00, 5038 00	5 ... 18 mA
Order no. 5040 00	5 ... 24 mA
Outputs	
Switching voltage	AC 250 V ~
Switching current AC1	16 A
Fluorescent lamps	16 AX
Current carrying capacity	
Neighbouring outputs	Σ 20 A
Loads per output	
Ohmic load	3000 W
Capacitive load	max. 16 A (140 μ F)
Motors	1380 VA
Switch-on current 200 μ s	max. 800 A
Switch-on current 20 ms	max. 165 A
Lamp loads 230 V	
Incandescent lamps	2300 W
HV halogen lamps	2300 W
HV-LED lamps	max. 400 W
LV halogen lamps with electronic transformers	1500 W
LV halogen lamps with inductive transformer	1200 VA
Fluorescent lamps T5/T8	
uncompensated	1000 W
parallel compensated	1160 W (140 μ F)
twin-lamp circuit	2300 W (140 μ F)
Compact fluorescent lamps	
uncompensated	1000 W

parallel compensated	1160 W (140 µF)
Mercury vapour lamps	
uncompensated	1000 W
parallel compensated	1160 W (140 µF)
Fitting width	
Order no. 5033 00	72 mm / 4 module
Order no. 5038 00	144 mm / 8 module
Order no. 5040 00	216 mm / 12 module
Weight	
Order no. 5033 00	approx. 230 g
Order no. 5038 00	approx. 500 g
Order no. 5040 00	approx. 740 g
Clampable conductor cross-section	
single stranded	0.5 ... 4 mm ²
Finely stranded without conductor sleeve	0.5 ... 4 mm ²
Finely stranded with conductor sleeve	0.5 ... 2.5 mm ²
Connection torque screw terminals	Max. 0.8 Nm

2 Safety instructions



Electrical devices may only be mounted and connected by electrically skilled persons.

Danger of electric shock. Device is not suitable for disconnection from supply voltage.

Danger of electric shock on the SELV/PELV installation. Do not connect loads for mains voltage and SELV/PELV together to the device.

Serious injuries, fire or property damage possible. Please read and follow manual fully.

Do not connect any three-phase motors. Device can be damaged.

For parallel connection of several motors to an output it is essential to observe the corresponding instructions of the manufacturers, and to use a cut-off relay if necessary. The motors may be destroyed.

Use only venetian blind motors with mechanical or electronic limit switches. Check the limit switches for correct adjustment. Observe the specifications of the motor manufacturers. Device can be damaged.

The device may not be opened or operated outside the technical specifications.

These instructions are an integral part of the product, and must remain with the end customer.

3 Fitting and electrical connection

**DANGER!**

Mortal danger of electric shock.

Disconnect the device. Cover up live parts.

**DANGER!**

Overloading the device leads to excessive heating.

Damage to the device and the connected cables may result.

Do not exceed the maximum current carrying capacity.

Fitting the device

In secure operation (preconditions):

- Secure commissioning is activated in the ETS.
- Device certificate entered/scanned or added to the ETS project. A high resolution camera should be used to scan the QR code.
- Document all passwords and keep them safe.

Observe ambient temperature. Ensure adequate cooling.

- Mount device on DIN rail.
- In secure operation: The device certificate must be removed from the device and stored securely.

Connecting the device

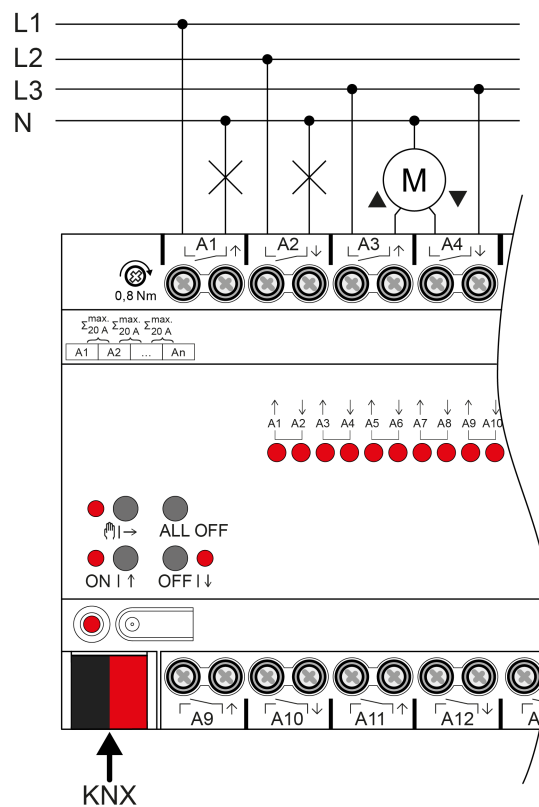

Image 2: Device connection (connection example):

- Connect bus line with KNX connecting terminal according to their correct polarity.
 - Attach the cover cap to the KNX connection as protection against hazardous voltages.
 - Connect load as shown in the connection example. Two adjacent relay outputs form a Venetian blind output.
- i** Venting louvers and roof windows must be connected to the outputs in such a way that they are opened in travel direction "UP" and closed in travel direction "DOWN".

The total current capacity of neighbouring outputs is a maximum of 20 A.

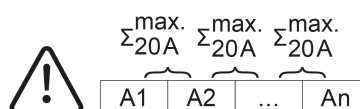

Image 3: Total current capacity of neighbouring outputs

4 Commissioning

Commissioning the device



NOTICE!

Incorrect load control due to undefined relay state at delivery.

Risk of destruction of connected drive motors.

During commissioning, before switching on the load, ensure that all relay contacts are open by applying the KNX bus voltage. Observe commissioning sequence!

- Switch on the KNX bus voltage.
 - Wait about 10 s.
 - Switch on load circuits.
- i** Delivery state: The outputs can be operated with manual control. Outputs are set as venetian blind outputs.

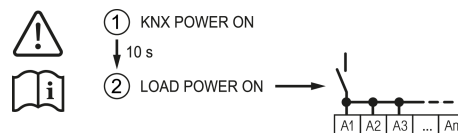

Image 4: Sequence during commissioning

Load physical address and application program

- For switched loads, configure the outputs as a switching output.
- For Venetian blind operation, configure the outputs as a Venetian blind output.
- In Venetian blind operation: measure blind/shutter and slat travel times and enter them in the parameter setting.
- Press the programming button.
The programming LED lights up.
- Load physical address and application program using the ETS.

Safe-state mode

The safe state mode stops the execution of the loaded application program.

- i** Only the system software of the device is still functional. ETS diagnosis functions and programming of the device are possible. Manual operation is not possible.

Activating the safe-state mode

- Switch off the bus voltage or remove the KNX device connection terminal.
- Wait about 15 s.

- Press and hold down the programming button.
- Switch on the bus voltage or attach the KNX device connection terminal. Release the programming button only after the programming LED starts flashing slowly.

The safe-state mode is activated.

With a new brief press of the programming button, the programming mode can be switched on and off as usual also in the safe-state mode. If Programming mode is active, the programming LED stops flashing.

Deactivating safe-state mode

- Switch off bus voltage (wait approx. 15 s) or carry out ETS programming.

Master reset

The master reset restores the basic device setting (physical address 15.15.255, firmware remains in place). The device must then be recommissioned with the ETS. Manual operation is possible.

During secure operation: A master reset deactivates device security. The device can then be recommissioned with the device certificate.

Performing a master reset

Precondition: The safe-state mode is activated.

- Press and hold down the programming button for > 5 s.

The programming LED flashes quickly.

The device performs a master reset, restarts and is ready for operation again after approx. 5 s.

Restoring the device to factory settings

Devices can be reset to factory settings with the Gira ETS Service App. This function uses the firmware contained in the device that was active at the time of delivery (delivery state). Restoring the factory settings causes the devices to lose their physical address and configuration.

5 Application programs

ETS search paths:	<ul style="list-style-type: none">- Output / Binary output mix / Switching actuator, 6-gang/ blind actuator, 3-gang Komfort- Output / Binary output mix / Switching actuator, 16-gang/ blind actuator, 8-gang Komfort- Output / Binary output mix / Switching actuator, 24-gang/ blind actuator, 12-gang Komfort
Name	Switching, shutter/blind 20D522 Switching, shutter/blind 20D622 Switching, shutter/blind 20D722
Version:	2.2 for ETS5 from Version 5.7.3 onwards and ETS6
Mask version	SystemB (07B0)
Summarized de- scription	Multifunctional switching/blind applications with logic functions and manual control. KNX Data Secure capable. Replaces the application program 2.1.

6 Scope of functions

General

- Blinds or switching operation parameterizable. In blind operation, the adjacent outputs A1/A2, A3/A4...) are combined into single Venetian blind outputs. Mixed operation on an actuator (for example A1 & A2 Venetian blind, A3 & A4 Venetian blind, A5 switching, A6 switching) is possible.
- Up to 8 independent logic functions for the implementation of simple or complex logic operations.
- Actively transmitting feedback or status messages can be delayed globally after bus voltage return or after ETS programming.
- Manual operation of outputs independent of the KNX (for instance, construction site mode) with LED status indicators. Separate status feedback to the KNX for manual operation. Manual control can also be disabled via the bus.

Venetian blind outputs

- Operating mode configurable: control of blinds with slats, shutters, awnings, roof windows or venting louvers.
- Separately configurable blind travelling times with travelling time extension for moves into the upper end position.
- For blinds with slats, a slat moving time can be independently configured
- Travel direction change-over time and the times for short-time and long-time operation (step, move) presettable.
- Reaction in case of bus voltage return and after an ETS programming operation adjustable for each output.
- Centralized control of all Venetian blind outputs of up to 6 central functions is possible (UP, DOWN, permanent UP, permanent DOWN)..
- Blind/shutter or slat position feedback telegram. In addition, an invalid blind position or an invalid travel movement can be reported back. Active (transmitting after changes or cyclically to the bus) or passive (object readout) feedback functions.
- Assigning of outputs to up to 5 different safety functions (3 wind alarms, 1 rain alarm, 1 frost alarm) optionally with cyclical monitoring. The safety functions (objects, cycle times, priority) are programmed device-oriented and in common for all outputs. The assignment of individual outputs to the safety functions and the safety measures can be configured for each channel.
- An extensive sun protection function with fixed and variable blind or slat positions at the beginning and at the end of the function can be activated separately for each output. Dynamic slat offset for slatted blinds included. Also with extended sun protection feature for integration into sophisticated shading control programs (operated via separate automatic and disabling object). Optionally also with automatic heating/cooling and presence detection function.
- Forced-position function or disabling function can be implemented for each Venetian blind output.

- Up to 64 internal scenes configurable per output.

Switching outputs

- Independent switching of the switching outputs.
- Operation as NO or NC contacts.
- Central switching of up to 6 switching objects (ON, OFF, permanent ON, permanent OFF) and collective feedback.
- Switching feedback mode: Active (transmitting after changes or cyclically to the bus) or passive (object readout) feedback function.
- Reaction in case of bus voltage failure and bus voltage return as well as after ETS programming is adjustable for each output.
- Logic function individual for each output.
- Disabling function can be parameterized for each channel. Forced position function separately for each output as an alternative.
- Timing functions (switch-on delay, switch-off delay, staircase lighting timer, also with pre-warning function)
- Incorporation into light moods: up to 64 internal scenes parameterizable per output.
- Operating hours counter can be activated independently for each output.
- Input monitoring for cyclical updating of the switching object with safety position.

Logic functions

- The device has 8 internal logic functions in addition to the Venetian blind or switching operation.
- Logic gates (e.g. AND, OR, OR, exclusive OR, each with up to 4 inputs).
- 1-bit to 1-byte converter with input filter, disabling object and presetting of the output values.
- Disabling element with filter and time functions and disabling object.
- Comparator for values with 9 different input data formats and many comparison operations.
- Limit switch with hysteresis with upper and lower threshold for 9 different input data formats. Incl. presetting of the 1-bit output values.
- The logic functions have their own KNX communication objects and can process telegrams of the actuator or of other bus devices.

7 Notes on software

Unloading the application program

The application program can be unloaded with the ETS. In this case the device is without function. Manual operation is no longer possible.

ETS project design and commissioning

For project design and commissioning of the device, ETS5 from Version 5.7.3 onwards or ETS6 is required. Project designing and commissioning of the device using ETS2, ETS3 or ET4 is not possible.

8 Operation and indication

8.1 Button operation and indication functions

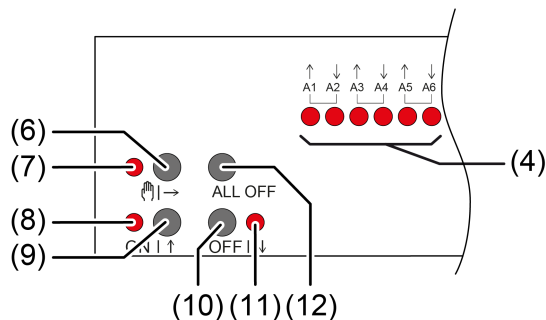

Image 5: Operating elements

- (4) Status LEDs for outputs
ON: Relay output closed
OFF: Relay output opened
Flashes slowly: Output in manual mode selected.
Flashes quickly: Output disabled via continuous manual mode
- (6) Button →
Manual operation
- (7) LED →
ON: Continuous manual mode active/Flashing: Temporary manual mode active
- (8) LED **ON** ↑
ON: Relay outputs closed, manual mode active
- (9) Button **ON** ↑
Short: Switch on, drive stop
Long: Move blind/shutter upwards
- (10) Button **OFF** ↓
Short: Switch off, drive stop
Long: Move blind/shutter downwards
- (11) LED **OFF** ↓
ON: Relay outputs opened, manual mode active
- (12) Button **ALL OFF**
Open all relay outputs, stop drives

In operation with the button field the device distinguishes between a short and a long press.

- Short: Pressing for less than 1 s
- Long: Pressing for between 1 and 5 s

i In switching operation, the device distinguishes between the "NO contact" and "NC contact" operating modes. The buttons (9 + 10) switch the switching state when actuated:

NO contact: Switch on = close relay, Switch off = open relay
 NC contact: Switch on = open relay, Switch off = close relay
 The LED (4 + 8 + 11) always indicate the relay state.

- i** The LEDs (4) optionally indicate the states of the outputs only temporarily (parameter-dependent).

Operating modes

- Bus operation: Operation via push-button sensors or other bus devices
 - Temporary manual control: manual control locally with keypad, automatic return to bus control
 - Continuous manual mode: Exclusively manual operation on the device
- i** No bus operation is possible in manual mode.
 - i** After a bus failure and restoration the device switches to bus operation.
 - i** The manual mode can be disabled in ongoing operation via a bus telegram.

Switching on the temporary manual control

Operation using the button field is programmed and not disabled.

- Press button \rightarrow (6) briefly.
 LED \rightarrow (7) flashes, LEDs A1... (4) of the first configured output or output pair flash.
 Short-time manual operation is switched on.
- i** After 5 s without a key-press, the actuator returns automatically to bus operation.

Switching off temporary manual operation

The device is in short-term manual mode.



- No button-press for 5 s.
 - or -
- Press \rightarrow (6) button briefly as many time as necessary until the actuator leaves the short-time manual mode.
 Status LEDs A1... (4) no longer flash, but rather indicate the relay status.
 Short-time manual operation is switched off.

Switching outputs: depending on the programming, the output relays switch to the position that is active after the manual mode is switched off, e.g. to the forced position, logic function.

Blind/shutter outputs: depending on the programming, the hangings move to the position that is active after the manual mode is switched off, e.g. to the forced position, safety or sun protection position.

Switching on permanent manual control



Operation using the button field is programmed and not disabled.

- Press the  (6) button for at least 5 s.
LED  (7) lights up, LEDs **A1...** (4) of the first configured output or output pair flash.

Continuous manual mode is switched on.

Switching off permanent manual control

The device is in continuous manual mode.





- Press the  (6) button for at least 5 s.
LED  (7) is off.

Continuous manual mode is switched off. Bus operation is switched on.

Switching outputs: depending on the programming, the output relays switch to the position that is active after the manual mode is switched off, e.g. to the forced position, logic function.

Blind/shutter outputs: depending on the programming, the hangings move to the position that is active after the manual mode is switched off, e.g. to the forced position, safety or sun protection position.

Operating an output in manual mode

- Activate short-term or permanent manual operation.
- Press button  (1) repeatedly until LED **A1...** (4) of the desired output or output pair flashes.
- Press button **ON** (9) or **OFF** (10).
Short: Switch on/off, drive stop
Long: Move blind/shutter upwards/downwards
LED **ON** (3) ON: Relay output closed
LED **OFF** (6) OFF: Relay output opened

 Short-term manual operation: After running through all of the outputs the device exits manual mode after another brief press.

Switching off all outputs / Stopping all hangings

The device is in continuous manual mode.

- Press the **ALL OFF** button (7).

Switching outputs: All outputs switch off (NO operating mode: relay output opened/NC operating mode: relay output closed).

Venetian blind outputs: All blinds/shutters stop.

Disabling outputs

The device is in continuous manual mode. The bus control can be disabled (ETS parameter).

- Press button  (6) repeatedly until LED **A1...** (4) of the desired output or output pair flashes.
- Press the / **ON**|↑ (9) and / **OFF**|↓ (10) buttons simultaneously for approx. 5 s. Selected output is disabled.

The status LED **A1...** (4) of the selected output or output pair flashes quickly.

 A disabled output can be operated in manual mode.

Re-enabling outputs

The device is in continuous manual mode. One or more outputs were disabled in manual mode.

- Press button  (6) repeatedly until the output to be unlocked or the output pair is selected.
- Press the / **ON**|↑ (9) and / **OFF**|↓ (10) buttons simultaneously for approx. 5 s. Disabling is deactivated.

The LED **A1...** (4) of the selected output or output pair flashes slowly.

8.2 ETS-Configuration

8.2.1 Manual operation

All outputs of the device have electronic manual operation. The button field with 4 function buttons and 3 status LEDs on the front panel of the device can be used for setting the following modes of operation:

- Bus operation: Operation via push-button sensors or other bus devices
- Short-term manual operation: Manual operation locally with button field, automatic return to bus operation.
- Permanent manual control: local manual control with keypad

Manual control is possible while the device is supplied with power from the bus supply voltage. In the state as supplied the manual control mode is fully enabled. In this unprogrammed state, all outputs are set to blinds operation and can be controlled by the manual operation so that fast function checking of the connected loads (e.g. on the construction site) is possible

After initial commissioning of the actuator via the ETS, manual control can be enabled or completely disabled.

Disabling manual control permanently

Manual operation is enabled in the as-delivered state. If the parameter of the same name is deactivated on the "Manual control" parameter page, no parameters and communication objects for manual control are available. The outputs can then only be controlled via the bus.

In the case of a temporary status indication, the status LEDs continue to indicate the status of the outputs when the "Manual control" button is pressed.

Disabling manual control temporarily

The manual control mode can be separately disabled via the bus, even if it is already active. If the disabling function is enabled, then as soon as a disabling telegram is received via the disabling object of the manual control, the actuator immediately terminates an activated manual control and locks the function keys on the front panel of the device. The telegram polarity of the disabling object is parameterisable.

The manual control mode must be enabled

- Activate the parameter "Disabling function" on the "Manual control" parameter page.
The disabling function of the manual control mode is enabled and the disabling object is visible.
- Select the desired telegram polarity in the parameter "Polarity of the disabling object".

- i** If the polarity is "0 = disabled; 1 = enabled", the disabling function is immediately active on return of bus voltage or after an ETS programming operation (object value "OFF"). To activate the manual control in this case, an enable telegram "ON" must first be sent to the disabling object.
- i** After return of bus voltage, a disabled state that was active beforehand is always inactive when the polarity of the disabling object is non-inverted.
- i** When an active manual control is terminated by a disable, the actuator will also transmit a "Manual control inactive" status telegram to the bus, if the status messaging function is enabled.

Presetting the behaviour at the beginning and at the end of manual control

The manual control distinguishes the temporary and permanent manual control. The behaviour is different depending on these modes of operation, especially at the end of manual control. It should be noted that the operation via the bus, i.e. control of the outputs by direct operation (switching / moving / scenes / central) or by the disabling or forced position functions is always disabled when the manual control is active. This means that the manual control mode has the highest priority.

Behaviour at the beginning of manual control:

The behaviour at the beginning of manual control does not differ for temporary and permanent manual control. When manual control is activated, all travel movements that were started beforehand by bus control for the venetian blind outputs will still be completed unless the travel movement in question is stopped by hand. Switching states of switching outputs will be maintained. Active forced-positions, disabling, safety and sun protection functions can be overridden by manual operation. These functions are reactivated after deactivation of the manual operation unless they have been cancelled in the meantime via the KNX. Then the function with the higher priority is always executed.

Behaviour at the end of manual control:

The behaviour at the end of manual control is different for temporary and permanent manual control. The temporary manual mode is shut off automatically when the last output has been addressed and when the select key  is pressed once more. During deactivation of the temporary manual operation mode, the actuator returns to 'normal' bus operation and does not change the states selected by manual control. If, however, a forced position, a disabling function, a safety function or a sun protection function (independent of priority) has been activated via the KNX before or during manual control, the actuator executes these functions with a higher priority again for the outputs concerned.

The permanent manual control mode is shut off, when the select key  is pressed for more than 5 seconds. Depending on the parameterization of the actuator in the ETS, the outputs will be set to the state last adjusted in the manual mode or to the state internally tracked (direct operation, forced position, disabling, safety or sun protection position) when the permanent manual mode is switched off. The parameter "End of permanent manual control" defines the corresponding reaction.

- Set the parameter "End of permanent manual control" to "no change".

All telegrams received during an active permanent manual control mode for direct operation (switching, long-time/short-time, positioning, central, scenes, control value telegrams) will be rejected. After the end of the permanent manual control mode, the current state of all outputs remains unchanged. If, however, a forced position, a disabling function, a safety function or a sun protection function (independent of priority) has been activated via the KNX before or during manual operation, the actuator executes these functions with a higher priority for the outputs concerned.

- Set the parameter "End of permanent manual control" to "track outputs".
During an active permanent manual control, all incoming telegrams (blinds operation exception: short-time telegrams – step/stop) are internally tracked. At the end of the manual operation, the outputs will be set to the tracked states or to the positions last set before the permanent manual operation for Venetian blind outputs. The individual priorities of the functions with respect to one another are taken into account here. Only the function with the greater priority is executed. Long time operation is not tracked in Venetian blind operation if the corresponding Venetian blind output is already in the appropriate end position.
- i** The operations triggered during manual operation update the states of the feedback and status objects. Telegrams are also transmitted to the KNX, if the signal objects concerned are enabled in the ETS and are configured as actively transmitting.
- i** During an ETS programming operation, an activated manual operation mode will always be terminated. In this case, the parameterised or predefined behaviour at the end of manual control will not be executed. The actuator executes the configured behaviour after ETS programming instead.

Presetting the status message function for the manual control mode

An actuator can transmit a status telegram to the KNX via a separate object when the manual operation is activated or deactivated. The status telegram can only be transmitted when the bus voltage is switched on. The polarity of the status telegram can be parameterised.

The manual control mode must be enabled

- Activate the parameter "Status" on the "Manual control" parameter page.
The status messaging function of manual control is enabled and the status object is visible.
- Specify in the parameter "Status object function and polarity" whether the status telegram is generally a "ON" telegram whenever the manual control mode is activated or only in those cases where the permanent manual mode is activated.
- i** The status object is always "OFF" when the manual control mode is deactivated.
- i** The "inactive" status is transmitted automatically to the bus after bus voltage return or an ETS programming operation.

- i** When active manual control is terminated by a disable, the actuator will also transmit a "Manual control inactive" status telegram to the bus.

Setting disabling of the bus control

Individual switching or Venetian blind outputs can be disabled locally by manual operation on the device, so that the connected loads can no longer be activated via the KNX telegram. Such disabling of the bus operation is initiated by operation in permanent manual operation and is indicated by rapid flashing of the status LEDs on the front panel of the device. The disabled outputs can then only be activated in permanent manual control.

The manual control mode must be enabled

- Activate the parameter "Disable bus control of individual outputs" on the parameter page "Manual control".

The function for disabling the bus control is enabled and can be activated locally. Alternatively, deactivating the parameter prevents disabling of the bus control from being activated in permanent manual operation.

- i** The disabling initiated locally has the highest priority. Thus all other functions of the actuator that can be activated via the KNX (e.g. forced position, disabling or safety function) are overridden. The bus-disabled output remains in the state last set in permanent manual control.

Depending on the parameterization of the actuator in the ETS, the outputs will be set to the state last adjusted in the manual mode or to the state internally tracked (direct operation, forced position, disabling, safety or sun protection position) when the permanent manual mode is reactivated and subsequently shut off.

- i** The disabling function of manual operation does not influence bus-disabled outputs.

- i** A failure of the bus voltage or an ETS programming operation deactivates disabling of the bus control.

8.2.2 Status indication

The status LEDs on the front of the device can indicate the current status of the switching and Venetian blind outputs permanently or temporarily.

- Continuous status indication:
The parameter "Indicate status temporarily" on the "Status indication" parameter page is deactivated. In the case of a continuous status indication, the status LEDs always indicate the current status of the outputs.
- Temporary status indication:
The parameter "Indicate status temporarily" on the "Status indication" parameter page is activated. During temporary indication, the status indication is activated by pressing the "Manual control" button. The display length is set in the ETS.

If manual control is enabled in the ETS, pressing the "Manual control" button also activates short-temporary or permanent manual control. The status indication always remains active during manual operation. At the end of manual operation, the display length of the temporary status indication is restarted. The status LEDs then go out after the configured time has elapsed.

If manual control is not enabled in the ETS, all status LEDs only show the status of the outputs when the "Manual control" button is pressed, depending on the duration of the display.

i In the as-delivered state, the continuous status indication is preset.

If the parameter "Control via object" is activated, the "Temporary status indication" communication object is available in the ETS. This object is bidirectional and can firstly signal the status of the temporary status indication, and secondly, activate the status display. If a temporary status indication has been activated by pressing the "Manual control" button, the object sends the value "ON". If the object receives a telegram with the value "OFF" or "ON", the status LEDs indicate the status of the outputs according to the display length. The manual control is not activated in this case.

By linking the "Temporary status indication" objects of several actuators using a common group address, the indication functions of the status LED can be synchronized with one another. It is thus possible to activate the status indications of all actuators in a control cabinet at the same time if the manual control only on one actuator - e.g. for service or maintenance purposes - is triggered.

In addition, the "Temporary status display" object could be controlled, for example, by a magnetic contact connected to the KNX, so that the status indications of all actuators are activated by opening the control cabinet door. If the door is closed, the status indications for energy saving remain switched off.

i During a running display length, the "Temporary status indication" object does not send any new telegrams if the "Manual control" button is pressed again.

8.3 Operation and indication parameter

Manual operation

Manual operation	Checkbox (yes / no)
Manual control is possible while the device is supplied with power from the bus supply voltage. This parameter defines whether manual operation is to be possible or deactivated permanently.	

Disabling function	Checkbox (yes / no)
Manual control can be disabled via the KNX, even if it is already active. For this purpose, the disabling object can be enabled here. This parameter is only visible if manual control is enabled.	

Polarity of the disabling object	0 = enabled; 1 = disabled 0 = disabled; 1 = enabled
This parameter sets the polarity of the disabling object. This parameter is only visible if the disabling function is enabled.	

Status	Checkbox (yes / no)
An actuator can transmit a status telegram to the KNX via a separate object when the manual operation is activated or deactivated. This parameter is only visible if manual control is enabled.	

Status object function and polarity	0 = inactive; 1 = manual operation active 0 = inactive; 1 = permanent manual operation active
This parameter defines the information contained in the status object. The object is always "OFF", when the manual control mode is deactivated. 0 = inactive; 1 = manual control active: The object is "ON" when the manual control mode is active (temporary or permanent). 0 = inactive; 1 = permanent manual control active: The object is only "ON", when the permanent manual control is active. This parameter is only visible if the status function is enabled.	

End of permanent manual control	no change Output tracking
<p>The behaviour of the actuator at the end of permanent manual control depends on this parameter. This parameter is only visible if manual control is enabled.</p> <p>no change: All telegrams received during an active permanent manual control mode for direct operation (switching, long-time/short-time, positioning, central, scenes, control value telegrams) will be rejected. After the end of the permanent manual operation, the current state of all outputs which was most recently active in manual operation remains unchanged. If, however, a forced position, a disabling function, a safety function or a sun protection function (independent of priority) has been activated via the KNX before or during manual operation, the actuator executes these functions with a higher priority for the outputs concerned.</p> <p>Track outputs: During an active permanent manual control, all incoming telegrams (blinds operation exception: short-time telegrams – step/stop) are internally tracked. At the end of the manual operation, the outputs will be set to the tracked states or to the positions last set before the permanent manual operation for Venetian blind outputs. The individual priorities of the functions with respect to one another are taken into account here. Only the function with the greater priority is executed. Long time operation is not tracked in Venetian blind operation if the corresponding Venetian blind output is already in the appropriate end position.</p> <p>This parameter is only visible if manual control is enabled.</p>	

Bus control of individual outputs can be disabled	Checkbox (yes / no)
<p>Individual outputs can be disabled locally during permanent manual control, so that the disabled outputs can no longer be controlled via the KNX. Disabling via manual operation is only permitted if this parameter is activated.</p> <p>This parameter is only visible if manual control is enabled.</p>	

Status indication

Indicating status temporarily	Checkbox (yes / no)
<p>The status LEDs on the front of the device can indicate the current status of the switching and Venetian blind outputs permanently or temporarily.</p> <p>Parameter deactivated: Continuous status indication. In this case, the status LEDs always indicate the current status of the outputs.</p> <p>Parameter activated: Temporary status indication. In this case, the status indication is activated by pressing the "Manual control" button. The display length is set in the ETS. If manual control is enabled in the ETS, pressing the "Manual control" button also activates short-temporary or permanent manual control. The status indication always remains active during manual operation. At the end of manual operation, the display length of the temporary status indication is restarted. The status LEDs then go out after the configured time has elapsed.</p>	

Display length (6...255)	6 ... 10 ... 255
<p>This parameter defines the display length if the temporary status indication is activated.</p>	

Control via object	Checkbox (yes / no)
<p>If the parameter "Control via object" is activated, the "Temporary status indication" communication object is available in the ETS. This object is bidirectional and can firstly signal the status of the temporary status indication, and secondly, activate the status display. If a temporary status indication has been activated by pressing the "Manual control" button, the object sends the value "ON". If the object receives a telegram with the value "OFF" or "ON", the status LEDs indicate the status of the outputs according to the display length. The manual control is not activated in this case.</p>	

8.4 Object list operation and indication

Object no.	Function	Name	Type	DPT	Flag
1	Disabling	Manual operation - input	1-bit	1,003	C, (R), W, -, A

1-bit object for disabling the manual control on the device. The polarity can be configured.

Object no.	Function	Name	Type	DPT	Flag
2	Status	Manual operation - output	1-bit	1,002	C, R, -, T, A

1-bit object for manual control status transmission. The object is "OFF", when manual control is deactivated (bus control). The object is "ON", when manual control is being activated. You can configure whether the temporary or the permanent manual control will be indicated as status information or not.

Object no.	Function	Name	Type	DPT	Flag
3	Temporary status indication	Manual operation - input/output	1-bit	1,017	C, (R), W, T, A

1-bit object to signal and activate the temporary status indication. This object is bidirectional and can firstly signal the status of the temporary status indication, and secondly, activate the status display. If a temporary status indication has been activated by pressing the "Manual control" button, the object sends the value "ON". If the object receives a telegram with the value "OFF" or "ON", the status LEDs indicate the status of the outputs according to the display length. The manual control is not activated in this case.

The object is only visible if the temporary status indication is activated

9 Channel configuration



CAUTION!

Incorrect control of the load in case of incorrect device configuration in the ETS!

Danger of destruction of the connected blind drives.

Adapt the device configuration (channel definition) in the ETS to the connected load!



CAUTION!

Operating the actuator outside its technical specification (see Technical Data) can cause relay contacts to melt.

Risk of destruction of the connected drive motors from melted relay contacts and resulting simultaneous energising of both travel directions.

Only ever operate the actuator within its technical specification!

Configuring channel definition

The device is used to activate electrical loads of up to two different building units that are typically used in a residential or office spaces or in a hotel room. The device has up to 24 potential-free relay outputs for this, depending on the variant. Two outputs together form a pair which can be configured in the ETS either for Venetian blind operation (combined outputs for UP and DOWN) or, alternatively, to switching operation (separate outputs).

The pair formation of the relay outputs allows mixed operation of the named operating modes. By combining the functions of the relay outputs, in many cases it is possible to plan and execute electrical installations on a room-specific basis.

A mechanical locking of the travel directions is not implemented since the outputs must be controllable separately in switching operation.

- Set the desired functions for the output pairs in the channel definition on the "General" parameter page.

Venetian blind: The appropriate output pair is configured to Venetian blind operation. Both outputs are combined into one blind channel. Suitable slatted Venetian blinds, shutters, awnings, roof windows or venting louvers can be controlled.

Switching: The appropriate output pair is configured to switching operation. Both outputs are programmed separately as two switching channels.

It is possible to deactivate output pairs by deselecting the parameter "Use" (e.g. as a reserve for future applications). Deactivated output pairs have no parameters or communication objects and cannot be controlled even with manual operation.

- i** The parameter and object configurations of the individual outputs depend on the parameters on the "General" page and are readjusted by the ETS when the channel definition is changed. Consequently, parameter settings or group address assignments to objects can be lost. For this reason, the channel definition should be reset when beginning the parameterization of the actuator.

10 shutter/blinds operation

10.1 Priorities

The actuator in blinds operation distinguishes between different functions that can have an effect on an output. In order to prevent conflicting states, each available function has a certain priority. The function with the higher priority overrides the function with the lower priority.

For blinds operation there are the following priorities...

- 1st priority: manual control (highest priority)
- 2nd priority: forced position & disabling function
- 3rd priority: safety function(s)

Priority levels 4 and 5 can be configured in the ETS. The options are then...

- 4th priority: sun protection function
- 5th priority: direct bus operation

or...

- 4th priority: direct bus operation
- 5th priority: sun protection function

or...

- 4th priority: sun protection function and direct bus operation

i Direct bus operation includes: short-time/long-time operation, positioning, scenes, central functions, reset behaviour, fabric stretching, end position correction.

The behaviour of some functions can be configured at the end (e.g. the behaviour at the end of a safety function or the behaviour at the end of the automatic sun protection). These predefined reactions are only executed if the actuator can then immediately switch to direct operation (lowest priority).

If another function with a lower priority (e.g. sun protection) has been activated during a function with a high priority (e.g. safety), the actuator executes the behaviour at the beginning of the function with the next lower priority (e.g. sun protection). The behaviour at the end of the function with the higher priority (e.g. safety) is then not executed!

10.2 General settings

10.2.1 Reset behaviour

Delay after bus voltage return

To reduce telegram traffic on the KNX line after bus voltage activation (bus reset), after connection of the device to the bus line or after programming with the ETS, it is possible to delay all actively transmitted feedback telegrams of the actuator outputs. For this purpose, a channel-independent delay can be specified (parameter "Delay after bus voltage return" on parameter page "General blind outputs"). Only after the configured time elapses are feedback telegrams for initialisation transmitted to the KNX.

Which of the telegrams are actually delayed and which are not can be specified for each Venetian blind output and for status function separately.

- i** The delay has no effect on the behaviour of the outputs. Only the bus telegrams for status or feedback are delayed. The outputs can also be activated during the delay after bus voltage return.
- i** A setting of "0" for the delay after bus voltage return deactivates the delaying function altogether. In this case, any messages, if actively transmitted, will be transmitted to the KNX without any delay.

10.2.1.1 Reset behaviour parameter

General -> General Venetian blind outputs

Delay after bus voltage return Minutes (0...59)	0...59
To reduce telegram traffic on the KNX line after bus voltage switch-on (bus reset), after connection of the device to the KNX line or after programming with the ETS, it is possible to delay various actively transmitting feedback telegrams of the Venetian blind function. For this purpose, a delay time can be defined here. Only after the configured time elapses are delayed feedback telegrams for initialisation transmitted to the KNX. Setting the delay time minutes.	
Seconds (0...59)	0...17...59
Setting the delay time seconds.	

10.2.2 Central functions

The actuator offers the possibility of linking selected individual or all Venetian blind outputs with up to six 1-bit communication objects. The behaviour during the control of an output via the central functions can be set to "Move" or alternatively to "Permanent" (long-time operation with priority).

Central function = "Move":

This function is comparable to various central group addresses that are linked to the "long-time operation" object of a Venetian blind output. The last command received (UP or DOWN) is executed. The polarity of the central telegram can be configured as inverted if necessary.

Central function = "Permanent":

The assigned Venetian blind outputs are controlled according to the parameterised command (UP or DOWN) and locked during central control. This means that no other central function with the "Move" function can control the locked output. Controls via normal objects for direct operation, e.g. long-time or short-time operation are possible. If an output is assigned to several permanent central functions, the parameterised command decides on the priority of the central function. A "permanent UP" has a higher priority than a "permanent DOWN" and thus is preferably executed. Activating a central function "permanent UP" deactivates other assigned functions for an output with the setting "permanent DOWN".

Activating a permanent central function initiates a long-time movement in the preset travel direction, if priority allows. Deactivating a permanent central function does not lead to a stop, so that an ongoing movement is not affected by this.

Example of permanent central functions

An output is assigned to central function 1 "move", central function 2 "permanent UP" and central function 3 "permanent DOWN". Central functions 2 and 3 are initially deactivated.

When a central telegram = "activate" on central function 3 is received, the assigned Venetian blind output moves down. In this state, it can no longer be controlled by central function 1, since a simple "move" has a lower priority. When a central telegram = "activate" on central function 2 is received, the assigned Venetian blind output moves up immediately. Central function 3 is thus deactivated automatically. Only when central functions 2 and 3 are deactivated can the assigned Venetian blind output be activated again by central function 1.

- i** After bus voltage return, all central functions are inactive. No central functions are saved in the event of a bus voltage failure.
- i** The duration of a move initiated by a central function is retriggerable by receiving further central telegrams of the same polarity and function.
- i** The duration of a move initiated by a central function is not retriggerable by receiving further central telegrams of the same polarity and function. If a move has expired, new central telegrams trigger a move again.
- i** Deactivating a permanent central function has no effect on scene delays. Activation ends any scene delays that may be running

Disconnect central functions

- Activate the central functions on the parameter page "General -> General Venetian blind outputs" with the parameter "Central functions".

The 6 central objects become visible in the ETS. Names can optionally be assigned for the central functions. The names should illustrate the use of the individual central functions (e.g. "Central DOWN", "Panic UP"). The names are only used in the ETS in the text of the central functions and central objects.

Assign Venetian blind outputs to the central functions

Each Venetian blind output can be assigned to the central functions.

The central functions must be enabled on the parameter page "General -> General Venetian blind outputs".

- Set the parameter "Function and polarity of the central object" on the parameter pages "Relay outputs ... -> VBO... - General" to the desired function.

The appropriate output is assigned to the central function. It can be influenced centrally.

- i** The blind, venting louver or slat position newly set by the central functions is tracked at the end of a travel movement in the feedback objects and also transmitted to the bus, if these are actively transmitting. It should be noted that the actuator can compute positions after application of the supply voltage only if a reference movement into the upper limit positions has been performed beforehand.

10.2.2.1 Central functions parameter

General -> General Venetian blind outputs

Central functions	Checkbox (yes / no)
If the parameter is activated, the 6 central functions of the Venetian blind outputs and thus the objects "Venetian blind central function ..." are enabled. An assignment of individual Venetian blind outputs to the central functions is only possible if the function is enabled.	

Name of the central functions	Free text
Names can optionally be assigned for the central functions. The names should illustrate the use of the individual central functions (e.g. "Central DOWN", "Panic UP"). The names are only used in the ETS in the text of the central functions and central objects.	

Relay outputs... -> VBO... - General

Central function X assignment (X = 1 ... 6)	Checkbox (yes / no)
These parameters assign the additional functions to the selected Venetian blind output. These parameters are only visible when central functions are enabled.	

Function and central object polarity	Move (1 = DOWN / 0 = UP) Move (0 = DOWN / 1 = UP) Permanent DOWN (1 = active / 0 = inactive) Permanent UP (1 = active / 0 = inactive)
The function and polarity of the central function is selected here. Move (1 = DOWN / 0 = UP): The last command received (UP or DOWN) is executed. The polarity of the central telegram is preset: 1 = DOWN / 0 = UP Move (0 = DOWN / 1 = UP): The last command received (UP or DOWN) is executed. The polarity of the central telegram is preset: 0 = DOWN / 1 = UP Permanent DOWN (1 = active / 0 = inactive): The assigned Venetian blind output is controlled in the DOWN direction and locked during central control. Permanent UP (1 = active / 0 = inactive): The assigned Venetian blind output is controlled in the UP direction and locked during central control. If an output is assigned to several permanent central functions, the parameterised command decides on the priority of the central function. A "permanent UP" has a higher priority than a "permanent DOWN" and thus is preferably executed. With permanent function, the polarity of the central telegram is always fixed: 1 = activate permanent control / 0 = deactivate permanent control These parameters are only visible when central functions are enabled and assigned.	

10.2.2.2 Object list central functions

Object no.	Function	Name	Type	DPT	Flag
5	Move	Venetian blind central function 1 - Input	1-bit	1,008	C, (R), W, -, A
6	Move	Venetian blind central function 2 - Input	1-bit	1,008	C, (R), W, -, A
7	Move	Venetian blind central function 3 - Input	1-bit	1,008	C, (R), W, -, A
8	Move	Venetian blind central function 4 - Input	1-bit	1,008	C, (R), W, -, A
9	Move	Venetian blind central function 5 - Input	1-bit	1,008	C, (R), W, -, A
10	Move	Venetian blind central function 6 - Input	1-bit	1,008	C, (R), W, -, A

1-bit object for central control of assigned Venetian blind outputs.
 With central function = "Move": The polarity of the central telegram can be configured as inverted if necessary.
 With central function = "Permanent UP", "Permanent DOWN": With permanent function, the polarity of the central telegram is always fixed: 1 = activate permanent control / 0 = deactivate permanent control

10.2.3 Safety functions

The actuator can handle up to five different safety functions. Each safety function has a communication object of its own so that the functions can be activated or deactivated independently of one another.

There are three different wind alarms available. These alarms, for instance, can be used to protect Venetian blinds or awnings from wind and gusts on several building facades. In addition or as an alternative, a rain alarm, for instance, as a protection for awnings, and a frost alarm as a protection against mechanical damage to lowered Venetian blinds in low temperatures can be activated and used. The telegram polarity of the safety objects is fixed: "0" = No alarm / "1" = Alarm.

Usually, weather stations, which record temperature, wind speed and rain via the sensors, control the communication objects of the safety function.

The safety functions are configured in common for all Venetian blind outputs. The different outputs of the actuator can be separately assigned to all or to individual safety functions. Only assigned outputs respond to a change in the state of the safety objects. The reactions at the beginning of an alarm message ("1" telegram) or at the end of an alarm message ("0" telegram) can be parameterized for each channel. Because outputs are also assigned to multiple safety alarms, the priority of incoming alarm signals can be preset for several channels. Thus, the three wind alarms have the same priority with respect to one another (logic OR). The order of priority of the wind alarms with respect to the frost alarm or to the rain alarm can be configured.

The communication objects for the safety alarms can be monitored for the arrival of cyclical telegrams. If there are no telegrams within a settable monitoring time, the device activates the safety movement for the output. The safety function is terminated as soon as a new "0" telegram is received.

Different monitoring times can be selected separately in the ETS for the wind alarms, rain alarm and frost alarm. A shared time is configured for the wind alarms. Each wind alarm has its own time control, so that the wind objects are checked separately for telegram updates.

Enabling the safety functions

The safety functions must first be globally enabled before they can be configured and used. After global enabling, the individual safety alarms can be enabled or disabled independently of one another.

- Activate the parameter "Safety functions" on the "General -> General Venetian blind outputs" parameter page.

The safety functions are enabled globally and the other parameters become visible.

- Activate the parameters "Wind alarm 1", "Wind alarm 2", "Wind alarm 3", "Rain alarm" and "Frost alarm" depending on functional requirements.

The necessary safety alarms are now enabled. The safety objects are visible and can be linked with group addresses.

-  An update of the safety objects ("ON" to "ON" or "OFF" to "OFF") shows no reaction.

- i** After failure of the bus voltage or after programming with the ETS, the safety functions are always deactivated.

Presetting the safety priorities

If several safety alarms are assigned to an output, it is important to preset the priority of the incoming safety telegrams. In so doing, an alarm with a higher priority overrides the alarms with the lower priorities. When safety alarm with the higher priority has ended, the safety alarm with the lower priority is executed on condition that it is active.

The safety functions must have been globally enabled.

- Set the parameter "Priority of safety alarms" on the "General ->"General Venetian blind outputs" parameter page to the required order of priority.

- i** The three wind alarms have the same priority with respect to one another (logic OR). The last telegram update to the wind alarm objects decides which of the wind alarms will be executed. The wind alarm is completely deactivated for an assigned output only after all three objects are inactive ("0").

Presetting cyclical monitoring

If cyclical telegram monitoring of the safety objects is necessary, the individual monitoring functions must be activated separately. The monitoring functions must be enabled and the monitoring times preset on the "General -> General Venetian blind outputs" parameter page.

The safety functions must have been globally enabled.

- If monitoring of the wind alarms is to be activated, the parameter "Monitoring", which is immediately below the wind alarms must be activated.

The monitoring function for the wind alarm objects is now activated. As soon as the monitoring function is activated, telegrams must be transmitted cyclically to all enabled wind alarm objects. If only one of the wind alarm telegrams is missing within the monitoring period, the wind alarm reaction will be executed for the output concerned.

- Specify the required monitoring time for the wind alarm objects in the "cycle time" parameters.

- If monitoring of the rain alarm is to be activated, the parameter "Monitoring", which is immediately below the rain alarm must be activated.

The monitoring function for the rain alarm object is now activated. As soon as the monitoring function is activated, telegrams must be transmitted cyclically to the rain alarm object.

- Specify the required monitoring time for the rain alarm object in the "cycle time" parameters.

- If monitoring of the frost alarm is to be activated, the parameter "Monitoring", which is immediately below the frost alarm must be activated.

The monitoring function for the frost alarm object is now activated. As soon as the monitoring function is activated, telegrams must be transmitted cyclically to the frost alarm object.

- Specify the required monitoring time for the frost alarm object in the "cycle time" parameters.
- i** The cycle time of the transmitters should be shorter than the monitoring time configured in the actuator in order to ensure that at least one telegram can be received during the monitoring time.

10.2.3.1 Safety functions parameter

General -> General Venetian blind outputs

Safety functions	Checkbox (yes / no)
When the safety functions of the actuator, which can number up to 5, are used and should thus be configurable, the channel-independent enabling of the function must take place here.	
Priority of safety alarms	wind -> rain -> frost wind -> frost -> rain rain -> wind -> frost rain -> frost -> wind frost -> rain -> wind frost -> wind -> rain
This parameter defines the priority ranking of the individual safety alarms. Interpretation: high -> medium -> low. The three wind alarms have the same priority with respect to one another. This parameter is only visible when the safety functions are enabled.	
Wind alarm 1	Checkbox (yes / no)
Here, the parameter can be used to enable the first wind alarm and thus to enable the communication object.	
Wind alarm 2	Checkbox (yes / no)
Here, the parameter can be used to enable the second wind alarm and thus to enable the communication object.	
Wind alarm 3	Checkbox (yes / no)
Here, the parameter can be used to enable the third wind alarm and thus to enable the communication object.	
Monitoring	Checkbox (yes / no)
If the enabled wind alarms are to be monitored cyclically for incoming telegrams to the safety objects, the monitoring function must be enabled here. Otherwise, there is no cyclical monitoring of the objects. As soon as the monitoring function is activated here, telegrams must be transmitted cyclically to all enabled wind alarm objects.	
Cycle time hours (0...23)	0...23
The wind alarm monitoring time is configured here. Sets the monitoring time hours.	
Minutes (1...59)	1...25...59
Sets the monitoring time minutes.	

Rain alarm	Checkbox (yes / no)
Here, the parameter can be used to enable the rain alarm and thus to enable the communication object.	
Monitoring	Checkbox (yes / no)
If the enabled rain alarm is to be monitored cyclically for incoming telegrams to the safety object, the monitoring function must be enabled here. Otherwise, there is no cyclical monitoring of the object. As soon as the monitoring function is activated, telegrams must be transmitted cyclically to the enabled rain alarm object.	
Cycle time hours (0...23)	0...23
The rain alarm monitoring time is configured here. Sets the monitoring time hours.	
Minutes (1...59)	1...25...59
Sets the monitoring time minutes.	
Frost alarm	Checkbox (yes / no)
Here, the parameter can be used to enable the frost alarm and thus to enable the communication object.	
Monitoring	Checkbox (yes / no)
If the enabled frost alarm is to be monitored cyclically for incoming telegrams to the safety object, the monitoring function must be enabled here. Otherwise, there is no cyclical monitoring of the object. As soon as the monitoring function is activated, telegrams must be transmitted cyclically to the enabled frost alarm object.	
Cycle time hours (0...23)	0...23
The frost alarm monitoring time is configured here. Sets the monitoring time hours.	
Minutes (1...59)	1...25...59
Sets the monitoring time minutes.	

10.2.3.2 Object list safety functions

Object no.	Function	Name	Type	DPT	Flag
11	Wind alarm 1	Venetian blind - Safety - Input	1-bit	1,005	C, (R), W, -, A
1-bit object for central activation or deactivation of the first wind alarm ("0" = wind alarm deactivated / "1" = wind alarm activated).					
Object no.	Function	Name	Type	DPT	Flag
12	Wind alarm 2	Venetian blind - Safety - Input	1-bit	1,005	C, (R), W, -, A
1-bit object for central activation or deactivation of the second wind alarm ("0" = wind alarm deactivated / "1" = wind alarm activated).					
Object no.	Function	Name	Type	DPT	Flag
13	Wind alarm 3	Venetian blind - Safety - Input	1-bit	1,005	C, (R), W, -, A
1-bit object for central activation or deactivation of the third wind alarm ("0" = wind alarm deactivated / "1" = wind alarm activated).					
Object no.	Function	Name	Type	DPT	Flag
14	Rain alarm	Venetian blind - Safety - Input	1-bit	1,005	C, (R), W, -, A
1-bit object for central activation or deactivation of the rain alarm ("0" = rain alarm deactivated / "1" = rain alarm activated).					
Object no.	Function	Name	Type	DPT	Flag
15	Frost alarm	Venetian blind - Safety - Input	1-bit	1,005	C, (R), W, -, A
1-bit object for central activation or deactivation of the frost alarm ("0" = frost alarm deactivated / "1" = frost alarm activated).					

10.2.4 Name of a Venetian blind output

Here, you can optionally assign a name for each Venetian blind output. The name is intended to illustrate the use of the output (e.g. "Venetian blind living room", "shutter bathroom"). The names are only used in the ETS in the text of the parameter pages and communication objects.

10.2.4.1 Parameter name

Relay outputs... -> VBO... - General

Name of shutter/blinds output	Free text
The text entered in this parameter is applied to the name of the communication objects and is used to label the Venetian blind output in the ETS parameter window (e.g. "Venetian blind, living room", "Shutter, bathroom"). The text is not programmed in the device.	

10.3 Operating mode

Each venetian blind output of the actuator can be independently configured for the drive type connected by defining the operating mode. The device permits the controlling of slatted Venetian blinds, shutters and awnings, or as a third alternative, roof windows. Depending on the preset operating mode, the ETS adapts the parameters and communication objects for all functions of an output.

For example, in the "Venetian blind" with slat" operating mode, there are also parameters and objects for slat control. There is no slat control in the "shutter/awning" operating mode, but a fabric stretching function can be configured for awning use. In the "Venting louver/roof window" operating mode, a distinction is made between the "opening" and "closing" drive movements, instead of an up or down movement for Venetian blinds or shutters

In this documentation, Venetian blinds, roller shutters or awnings are also designated with the term "blind", if the text does not explicitly refer to a particular function (e.g. slat control).

In all modes it is possible to specify positions.

Presetting the operating mode

The parameter "operating mode" exists separately for each venetian blind output on the parameter page "Relay outputs... -> VBO... - General".

- Select the required operating mode in the "Operating mode" parameter.

- i** The "Operating mode" parameter has an influence on many channel-oriented parameters and communication objects. When the operating mode is changed in the ETS, the parameters are adapted dynamically so that settings already made or links between group addresses can be reset. For this reason, the required operating mode should be configured at the beginning of the channel-oriented device configuration.
- i** Venting louvers and roof windows must be connected to the outputs in such a way that they are opened in travel direction "UP" and closed in travel direction "DOWN".
- i** An awning travels upwards when it is rolled up.

10.3.1 Operating mode parameter

Relay outputs... -> VBO... - General

Operating mode	Venetian blind with slat Shutter / awning Venting louver/roof window
<p>The actuator can control various drive systems. This parameter defines which type of curtain is connected to the output.</p> <p>The ETS adapts all of the following parameters (designations, visible/non visible, etc.) dynamically to the respective "operating mode" parameter. For this reason, the "Operating mode" parameter should be adjusted before all other parameters of an output.</p>	

10.4 Reset and initialisation behaviour

Presetting the behaviour after ETS programming

The parameter "After ETS programming" exists separately for each Venetian blind output on the parameter page "Relay outputs... -> VBO... - General". This parameter can be used to configure the relay behaviour of the output, irrespective of the behaviour after bus voltage return.

Depending on the selected operating mode, the ETS adapts the designations of the parameter settings ("raising" ↔ "opening" / "lowering" ↔ "closing").

- Set the parameter to "stop".
After programming with the ETS, the actuator switches the relays of the output to the "stop" position. A travel movement, if any, will be interrupted.
 - Set the parameter to "raising" or "opening".
After programming with the ETS, the actuator raises the blind or opens the venting louver/roof window.
 - Set the parameter to "lowering" or "closing".
After programming with the ETS, the actuator lowers the blind or closes the venting louver/roof window.
 - Set the parameter to "as after bus voltage return".
After an ETS programming operation, the actuator will behave in the manner specified in the parameter "After bus voltage return".
- i** The parameterised behaviour "After ETS programming" will be executed after every ETS application or parameter download. A simple download of the physical address alone or partial programming of only the group addresses has the effect that this parameter is disregarded and that the configured behaviour "After after bus voltage return" will be executed instead.
- i** After programming with the ETS, the safety functions, the forced positions and the sun protection function are always deactivated.

Setting the behaviour in case of bus voltage failure

The parameter "In case of bus voltage failure" exists separately for each Venetian blind output on the parameter page "Relay outputs... -> VBO... - General". In case of bus voltage failure, the actuator always switches the relays of the output to the "stop" position. A travel movement, if any, will be interrupted.

The configured behaviour will not be adopted, if a manual control mode is active at the time of bus failure.

- i** When there is a bus voltage failure, the current position data of the outputs is permanently saved internally, so that these position values can be accurately tracked after bus voltage return, should this be configured. The data will not be stored, if the position data is unknown. The following rules apply for the position data to be stored:

The current blind, slat, venting louver and roof window positions are stored. With Venetian blinds, the height to be stored is always referred to a slat position of 100 % (cf. "Calculating the slat position"). Positions temporarily approached will be stored also for those outputs that are involved in a travel movement at the time of data storage. On account of the fact that position data is stored as integer percentage values (0...100), a minor deviation from the positions reported back later during bus voltage return (number range 0..255) cannot be avoided.

In case of ETS programming, the saved position data is not lost.

- i** In case of bus voltage failure, the current states of the forced position control or – if configured – also the slat offsets of the sun protection positions are stored as well.

Setting the behaviour after bus voltage return

The parameter "After bus voltage return" exists separately for each Venetian blind output on the parameter page "Relay outputs... -> VBO... - General". Depending on the selected operating mode, the ETS adapts the designations of the parameter settings ("raising" ↔ "opening" / "lowering" ↔ "closing").

- Set the parameter to "stop".
In case of bus voltage return, the actuator switches the relays of the output to the "stop" position. A travel movement, if any, will be interrupted.
- Set the parameter to "raising" or "opening".
In case of bus voltage return, the actuator raises the blind/shutter or opens the venting louver/roof window.
- Set the parameter to "lowering" or "closing".
In case of bus voltage return, the actuator lowers the blind/shutter or closes the venting louver/roof window.
- Set the parameter to "position approach".
In case of bus voltage return, the connected drive can approach a position (0...100 %) specified by further parameters. If Venetian blinds are controlled with the device, the slats can be positioned independently. The actuator performs a reference movement before the position approach, because the current position at the time of bus voltage return is unknown.

- i** The forced position communication object can be initialised separately after bus voltage return. This has an effect on the reaction of the output when the forced position is activated.
The configured behaviour "In case of bus voltage return" is only executed when no forced position is activated after a bus voltage return.

- i** The Venetian blind operation is set as the default in the unprogrammed delivery state of the device. In this state, the relays are switched to the "stop" state when the bus voltage is applied in order to initialise the relays. This short switching operation can be perceived acoustically.

10.4.1 Reset and initialisation behaviour parameter

Relay outputs... -> VBO... - General

After ETS programming operation	stop raising / opening lowering / closing like after bus voltage return
---------------------------------	---

The actuator permits setting the preferred relay contact position after ETS programming separately for each output.

raising / opening: After programming with the ETS, the actuator raises the blind/shutter or opens the venting louver/roof window.

lowering / closing: After programming with the ETS, the actuator lowers the blind/shutter or closes the venting louver/roof window.

stop: After programming with the ETS, the actuator switches the relays of the output to the "stop" position. A travel movement, if any, will be interrupted.

like after bus voltage return: After an ETS programming operation, the actuator will behave in the manner specified in the parameter "After bus voltage return".

In case of bus voltage failure	stop
--------------------------------	-------------

The behaviour of the actuator is predefined in case of bus voltage failure. The actuator switches the relays of the output to the "stop" position. A travel movement, if any, will be interrupted.

after bus voltage return	stop raising / opening lowering / closing approaching a position
--------------------------	--

The actuator permits setting the preferred relay contact position after bus voltage return separately for each output.

stop: In case of bus voltage return, the actuator switches the relays of the output to the "stop" position. A travel movement, if any, will be interrupted.

raising / opening: In case of bus voltage return, the actuator raises the blind/shutter or opens the venting louver/roof window.

lowering / closing: In case of bus voltage return, the actuator lowers the blind/shutter or closes the venting louver/roof window.

Approach position: In case of bus voltage return, the connected drive can approach a position specified by further parameters.

Position of Venetian blind (0...100%)	0...100
---------------------------------------	----------------

This parameter specifies the blind position to be approached in case of bus voltage return.

This parameter is only visible if the behaviour "After bus voltage return" in the "Venetian blind" operating mode is set to "Approach position".

Slat position (0...100%)	0...100
<p>This parameter specifies the slat position to be approached in case of bus voltage return after the blind has been positioned at the desired height.</p> <p>This parameter is only visible if the behaviour "After bus voltage return" in the "Venetian blind" operating mode is set to "Approach position".</p>	
Shutter/awning position (0...100%)	0...100
<p>This parameter specifies the roller shutter or awning position to be approached in case of bus voltage return.</p> <p>This parameter is only visible if the behaviour "After bus voltage return" in the "shutter/awning" operating mode is set to "Approach position".</p>	
Position of venting louver (0...100%)	0...100
<p>This parameter specifies the venting louver/roof window position to be approached in case of bus voltage return.</p> <p>This parameter is only visible, if the behaviour "After bus voltage return" in the operating mode "Venting louver/roof window" is set to "Approach position".</p>	

10.5 Short-time / Long-time operation, travelling times

10.5.1 Short-time / Long-time operation

Determining and configuring short-time and long-time operation

The short-time operation (Step) permits adjusting the slat tilting angle of a Venetian blind or the 'slit opening width' of a shutter. In most cases, short-time operation is activated by pressing a Venetian blind pushbutton sensor permitting manual intervention in the blind controller. When the actuator receives a short-time command while the Venetian blind, shutter, awning or louver is in motion, the travel movement is stopped immediately by the actuator.

A long-time operation (Move) is determined by the travel time of the connected Venetian blind, shutter/awning or louver and must therefore not be preset separately. The movement time must be measured manually and entered into the ETS parameters. The control of an output by means of a long-time or a short-time telegram is also designated as 'direct operation'.

To ensure that the curtain or the louver has definitely reached its end position at the end of long time operation, the actuator always prolongs the long time movement by 20 % of the configured or learnt movement time. The parameterized travelling time extension will moreover be taken into account by the actuator for all upward travels or all travel movements into the open position as the drive motors are then generally no so fast due to the weight of the curtains or to external physical influences (e.g. temperature, wind, etc.). Thus, it is ensured that the upper end position is always reached even in case of uninterrupted long time travel movements.

- i** A long time or a short time operation can be retriggered by a new incoming long time or short time telegram.
- i** A travel movement activated in the manual control mode or by a safety function is always a long-time operation. The "raising" or "lowering" commands configured in the ETS will equally activate the long time operation.

Presetting the short time operation

Short-time operation is configured separately for each output and independent of the travel time of the blind/shutter or louver/roof window. It is possible to specify in the ETS whether the output executes only a "stop" for a travel movement on reception of a short time telegram or whether the output is activated for a specific duration.

- Set the parameter "Short time operation" on the parameter page "Relay outputs... -> VBO... - General -> Times" to "yes".

The actuator activates the output concerned for the time specified under "Duration of short-time operation" when a short-time telegram is received and when the output is not in the process of executing a travel movement. If the output is executing a travel movement at the time of telegram reception, the output will only just stop.

- Set the "Short time operation" parameter to "no (only stop)"..

The actuator will only stop the output on reception of a short time telegram, if the output is in the process of executing a travel movement. There will be no reaction, if the output is not executing a movement at the time of telegram reception.

- i** The configured "Duration of short time operation" for a Venetian blind should correspond to approx. $\frac{1}{4}$ of the complete slat travel time and for a shutter to the full travel time needed for opening a shutter.
- i** The short time operation is always executed without a movement time extension.

10.5.2 Setting the travel time

Determining and configuring travel times (manual entry of travel times)

For computing positions and also for executing long time operation, the actuator needs the exact travel time of the connected Venetian blind, shutter/awning or louver/roof window. The movement times must be measured manually and entered into the ETS configuration. It is important to determine the movement time accurately to permit positions to be approached with good precision. Therefore, it is recommended to make several time measurements, then to take the average of the measured values and enter them in the corresponding parameters. The travel time corresponds to the duration of a travel movement from the completely open position (upper end position / awning rolled up) to the completely closed position (lower end position / awning completely unrolled). Not vice-versa! The movement times are to be determined as a function of the different types of drives.

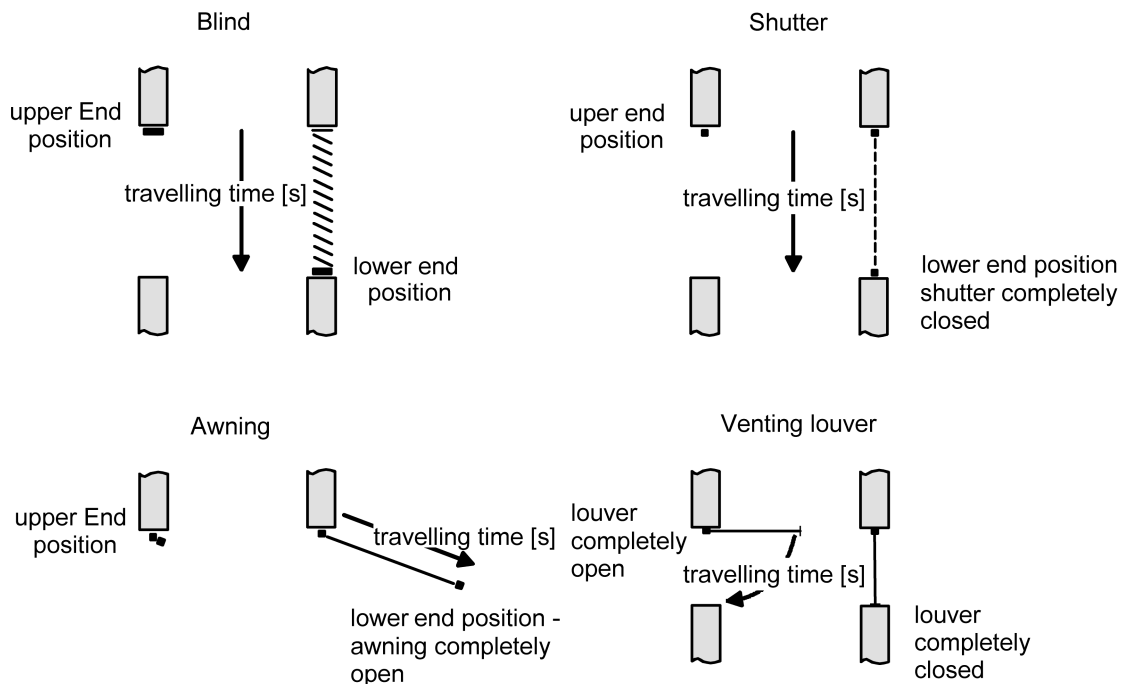

Image 6: Determining the movement time according to the drive type

Determining and configuring travel times (Setting travel time via the bus)

Apart from the classic setting of the travel time via ETS parameters for each Venetian blind output, it is possible to learn (teaching) the travel time of the blind or the venting louver/roof window to simplify the commissioning of facades with identical drives (i.e. identical travel times!). Here, a manually determined travel time of a master Venetian blind output is automatically forwarded to other Venetian blind outputs (slaves).

A Venetian blind output can be configured as a master or slave. An output configured as a master defines the travel time of the slave outputs of the same actuator and also other actuators of the same type. Slave venetian blind outputs always acquire their travel time from the 2-byte communication object "Travel time (slave)". The master Venetian blind output transmits its travel time via the "Travel time (master)" object. As a result, the objects "travel time (master)" and "travel time (slave)" must always be linked with each other via the same group address!

If the travel time is set via the bus, only one Venetian blind output may be the master in a master-slave application!

Procedure for setting a travel time via the bus (master-slave):

- The master Venetian blind output must first learn its travel time. The learn mode is started via the "Measurement of travel time enable" object on the actuator of the master Venetian blind output by means of an "ON" telegram.
- Move the master Venetian blind output fully up / fully open by means of a long-time telegram "UP".
- After the movement has been completed, lower the master Venetian blind output using a long time telegram "DOWN". The master Venetian blind output thereby starts the time measurement.
- Stop the movement immediately after reaching the lower limit / fully closed position using a short-time telegram. The travel time measurement is stopped and temporarily stored internally.
- Afterwards, the provisionally determined time can then be corrected or finely tuned by means of further measurements. To do this, repeat the measuring process by moving the master venetian blind output again upwards / opening it completely by means of a long-time telegram "UP". After the movement has been completed, move the master Venetian blind output down again using a long-time telegram "DOWN" and stop the movement again using a short-time telegram when the lower end position / fully closed position is reached.
- To end the learning of the master Venetian blind output travel time, stop the learn mode via the "Measurement of travel time enable" object by means of an "OFF" telegram. The actuator then sends the last determined travel time to the bus via the "Travel time (master)" object and returns to normal operation. Bus events received during learning mode (e.g. positions, safety or sun protection functions) are not updated!
- The Venetian blind outputs in slave mode wait for time preset of the master output. As soon as a travel time is received via the "Travel time (slave)" object, all slave outputs apply the travel time in their own configuration.

- i** A learned travel time is stored permanently and remains unchanged even after a bus voltage failure and after ETS programming.
- i** If no travel time has been determined via the bus after the function has been enabled in the ETS, the travel time configured in the ETS for the parameter "Travel time ... (default setting)" is used for the master and slaves. The travel time configured in the ETS loses its validity once a learning mode has been started and successfully completed. The ETS travel time is first valid again when the parameter "Setting travel time via the bus" is reset to "no (travel time only by parameter)".
- i** If the learning mode on the master was terminated without determining a valid travel time (object "Measurement of travel time enable" = "OFF" before a time measurement expires), the last validly determined time is transmitted via the object "travel time (master)". If no valid travel time has yet been determined, the blind travel time set in the ETS is used after the learning mode has been cancelled

Enabling setting travel time via the bus

If the setting travel time via the bus (master-slave) is to be used, the function must first be enabled globally for the actuator on the parameter page "General -> General Venetian blind outputs".

- Activate the parameter "Setting the travel time via the bus".
The function is activated globally. The communication objects "Measurement of travel time enable", "Travel time (master)" and "Travel time (slave)" are visible.

The blind channels can be configured on the parameter page "Relay outputs... -> VBO... - General -> Times" of the master or slave operation.

Setting the travel time of Venetian blinds, shutters/awnings and louvers

A distinction is made as to whether the travel time is configured individually for each Venetian blind output using ETS parameters, or whether the travel time is to be set via the bus (master-slave).

In case of individual configuration of the travel time:

- Set the parameter "Setting travel time via the bus" on the parameter page "Relay outputs... -> VBO... - General -> Times" to "no (travel time only by parameter)".
The Venetian blind output operates independently with regard to its travel time. The time is not preset via the bus.
- Enter the exact travel times determined in the course of the commissioning procedure into the "Venetian blind travel time" or "Shutter/awning travel time" or "Venting louver/roof window travel time" parameters. The maximum travelling time is 19 minutes 59 seconds. The working principle does not allow longer movement times.

- i** The parameterized travelling time extension will moreover be taken into account by the actuator for all upward travels or all travel movements into the open position as the drive motors are then generally no so fast due to the weight of the curtains or to external physical influences (e.g. temperature, wind, etc.).

When setting the travel time via the bus:

- Set the parameter "Setting travel time via the bus" on the parameter page "Relay outputs... -> VBO... - General -> Times" to "yes (travel time by KNX, Master)".
The Venetian blind output is configured as a master and specifies the travel time for other slave outputs. There can only be one master in a master-slave application!
- Set the parameter "Setting travel time via the bus" to "yes (travel time by KNX, slave)".
The Venetian blind output is configured and receives its travel time from the master output. There can be any number of slaves in a master-slave application (on the same actuator or with other actuators).
- The parameters "Venetian blind travel time (default setting)" or "Shutter/awning travel time (default setting)" or "Venting louver travel time / roof window (default setting)" initialise the affected outputs with a valid travel time, provided that no learning mode has been executed on the master and consequently no learned travel time exists yet. The travel time configured in the ETS loses its validity once a learning mode has been started and successfully completed. The ETS travel time is first valid again when the parameter "Setting travel time via the bus" is reset to "no (travel time only by parameter)".

10.5.3 Setting slat travel times (with slatted Venetian blinds)

Determining and configuring the slat moving time (only with slatted Venetian blinds)

If Venetian blinds are controlled, the slats can be positioned independently. To enable the actuator to compute slat positions and to report them back to the bus, it is necessary that the actuator gets precise information about the time required for a slat rotation. The slat moving time must in each case be determined manually and entered into the parameters.

The actuator is designed in such a way that it can control single-motor Venetian blind drives without a working position. In this drive mode, the slats are directly adjusted by way of mechanical linkage when the height of the Venetian blind is changed. The actuator assumes that the slats are completely closed when the Venetian blind moves downwards. The actuator assumes that the slats are completely closed when the Venetian blind moves downwards .

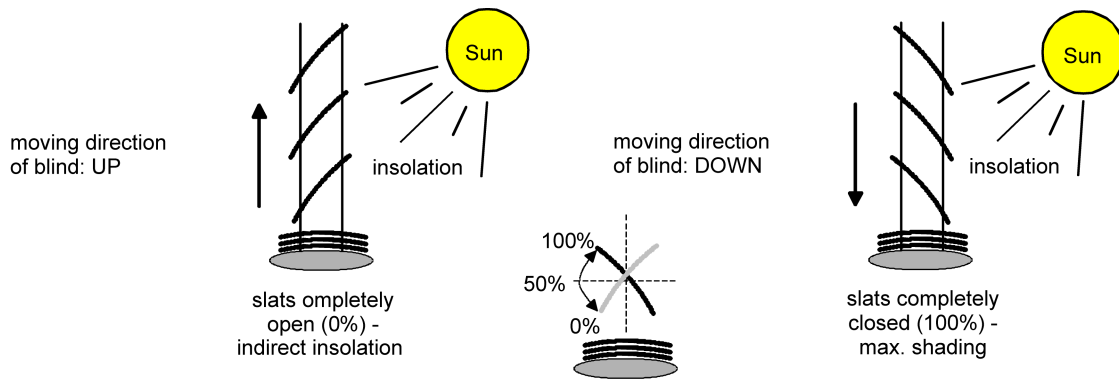

Image 7: Type 1 - Slatted Venetian blinds with oblique slat position in both travel directions

There are also single-motor Venetian blind systems without a working position the slats of which are horizontal during an upward travel and oblique during a downward travel. Such blind types can also be connected to the actuator, in which case a completely open slat position corresponds to the slats in horizontal position.

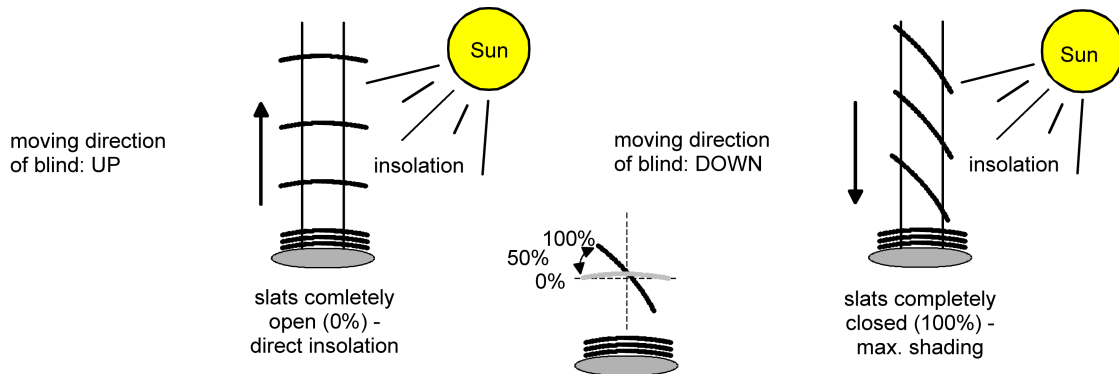

Image 8: Type 2 - Slatted Venetian blinds with oblique and horizontal slat position

Presetting the slat moving time

- Set the parameter "Slat travel time" on the parameter page "Relay outputs... -> VBO... - General -> Times" exactly to the value determined in the course of the commissioning procedure.
- i** The slat moving time must be shorter than the preset or learnt blind travelling time.
- i** The configured movement time extension will also be taken into account when slats are moved into the completely open position (upward movement).

10.5.4 Presetting the travel time extension and switchover time

Presetting the movement time extension

- In the parameter "Travel time extension for upward travel" on the parameter page "relay outputs... -> VBO... - General -> Times" enter the determined travel time extension (by rounding up the determined extension value if necessary)

Presetting the switchover time for movement direction changes

- Set the parameter "Switchover time for travel direction change" on the parameter page "Relay outputs... -> VBO... - General -> Times" to the required switchover interval.

i In the as-delivered state of the actuator, the switchover time is generally preset to 1 s.

10.5.5 Short-time / Long-time operation, travel times parameter

General -> General Venetian blind outputs

Setting the travel time via the bus	Checkbox (yes / no)
<p>If setting the travel time via the bus (master-slave) is to be used, the function must first be enabled globally by this parameter. If the function is not enabled globally, all Venetian blind outputs of the actuator work individually with regard to their travel time.</p>	

Relay outputs... -> VBO... - General -> Times

Setting travel time via the bus	no (travel time only by parameter) yes (travel time by KNX, Master) yes (travel time by KNX, Slave)
<p>A distinction is made as to whether the travel time is configured individually for each Venetian blind output using ETS parameters, or whether the travel time is to be set via the bus (master-slave).</p> <p>no (travel time only by parameter): The Venetian blind output operates independently with regard to its travel time. The time is not preset via the bus.</p> <p>yes (travel time by KNX, Master): The Venetian blind output is configured as a master and specifies the travel time for other slave outputs. There can only be one master in a master-slave application!</p> <p>yes (travel time by KNX, slave): The Venetian blind output is configured and receives its travel time from the master output. There can be any number of slaves in a master-slave application (on the same actuator or with other actuators).</p> <p>This parameter is only visible if the setting of travel time via the bus has been globally enabled.</p>	

Venetian blind travel time minutes (0...19)	0...1...19
<p>This parameter defines the travelling time of the Venetian blind. The time needed for a complete travel from the upper into the lower end position must be determined. Sets the minutes of the Venetian blind travelling time. This parameter is only visible in the venetian blind operating mode.</p>	

Seconds (0...59)	0...59
<p>Sets the seconds of the Venetian blind travelling time. This parameter is only visible in the venetian blind operating mode.</p>	

Shutter/awning travel time minutes (0...19)	0...1...19
<p>This parameter defines the travelling time of the shutter or awning. The time needed for a complete travel from the upper into the lower end position must be determined. Sets the minutes of the shutter/awning moving time. This parameter is only visible in the shutter/awning operating mode.</p>	

Seconds (0...59)	0...59
Sets the seconds of the shutter/awning moving time. This parameter is only visible in the shutter/awning operating mode.	
Venting louver travel time minutes (0...19)	0...1...19
This parameter defines the travelling time of the venting louver. The time needed for a complete travel from the completely open into the completely closed position must be determined. Sets the minutes of the venting louver travelling time. This parameter is visible only in the venting louver operating mode.	
Seconds (0...59)	0...59
Sets the seconds of the venting louver travelling time. This parameter is visible only in the venting louver operating mode.	
Slat travel time minutes (0...19)	0...19
This parameter defines the travelling time of the slats. The time needed for a complete movement from the completely open slat position into the completely closed slat position (travel movement DOWN) must be determined. Sets the minutes of the slat moving time. This parameter is only visible in the venetian blind operating mode.	
Seconds (0...59)	0...2...59
Sets the seconds of the slat moving time. This parameter is only visible in the venetian blind operating mode.	
Milliseconds (0...900)	0...100...900
Sets the milliseconds of the slat moving time. This parameter is only visible in the venetian blind operating mode.	
Short time operation	no (only stop) yes
This parameter can be used to configure the reaction to a received short time telegram. no (only stop): The drive will only be stopped if it is executing a movement at the time of telegram reception. There is no reaction if no movement is in progress. yes: Short-time operation is started on reception of a short-time telegram when the drive is stationary. If the drive is in motion at the time of telegram reception, it will be stopped.	
Duration of short time operation seconds: (0...59)	0...59
This parameter defines the duration of short-time operation. Sets the monitoring time seconds. This parameter is only visible, if the parameter "Short-time operation" is set to "yes".	

Milliseconds (0...990)	0...10... 500 ...990
<p>Sets the monitoring time milliseconds. The duration of short time operation should in no case exceed half the slat adjusting time. This parameter is only visible, if the parameter "Short-time operation" is set to "yes".</p>	
Switchover time for travel direction change	0.5 s 1 s 2 s 5 s
<p>This parameter specifies the break in a travel direction change (switchover time).</p>	
Travel time extension for upward travel	none 0.5% 1% 1.5% 2% 3% 4% 5% 6% 7% 8% 9% 10% 12.5% 15% 30%
<p>The actuator extends all the up movements or all venting louver/roof window movements into the opened position using the extension configured here. The time extension expressed in percent is the difference between the measured travel time needed to reach the lower end position (completely closed position) and the time needed to reach the upper end position (completely open position).</p>	

10.5.6 Object list Short-time / Long-time operation, travel times

General objects

Object no.	Function	Name	Type	DPT	Flag
16	Measurement of travel time enable	Venetian blind - travel times - input	1-bit	1,003	C, (R), W, -, A

1-bit object for starting and ending the automatic travel time measurement (teaching). Polarity: 1 = start measurement / 0 = end measurement, abort.
This object is only visible if "Setting the travel time via the bus" is enabled (see parameter page "General -> General Venetian blind outputs").

Object no.	Function	Name	Type	DPT	Flag
17	Travel time (master)	Venetian blind - travel times - output	2 bytes	7,004	C, R, -, T, A

2-byte object for transmitting the learned travel time of a master output to other slave Venetian blind outputs of the same device or to other actuators (slaves). At least one Venetian blind output must be configured as a master! In the case of a master-slave application, this object must always be linked to the "Travel time (slave)" object of the same actuator or other actuators via an identical group address to specify a travel time via the bus!

This object is only visible if "Setting the travel time via the bus" is enabled (see parameter page "General -> General Venetian blind outputs").

Object no.	Function	Name	Type	DPT	Flag
18	Travel time (slave)	Venetian blind - travel times - input	2 bytes	7,004	C, (R), W, -, A

2-byte object for receiving the learned travel time of a master output for other actuators (slaves). At least one Venetian blind output must be configured as a master in the same or in a different actuator! In the case of a master-slave application, this object must always be linked to the "Travel time (slave)" object of the same actuator or other actuators via an identical group address to specify a travel time via the bus!

This object is only visible if "Setting the travel time via the bus" is enabled (see parameter page "General -> General Venetian blind outputs").

Objects per Venetian blind output

Object no.	Function	Name	Type	DPT	Flag
20, 44...	Long-time operation	Venetian blind... - Input	1-bit	1,008	C, (R), W, -, A

1-bit object for activation of long time operation

Object no.	Function	Name	Type	DPT	Flag
24, 45...	Short time operation	Venetian blind...- Input	1-bit	1,007	C, (R), W, -, A

1-bit object for activation of short time operation or for stopping a drive movement.

10.6 Position calculation, position presetting and feedbacks

10.6.1 Position calculation and position presetting

Calculating the curtain height or the louver position

The actuator has a comfortable and accurate positioning function. The actuator calculates the current position of the connected Venetian blind, shutter, awning or venting louver or roof window whenever these elements are adjusted either by manual or bus control. The calculated position value is a measure of the height of the blind/shutter or of the opening width of the venting louver/roof window.

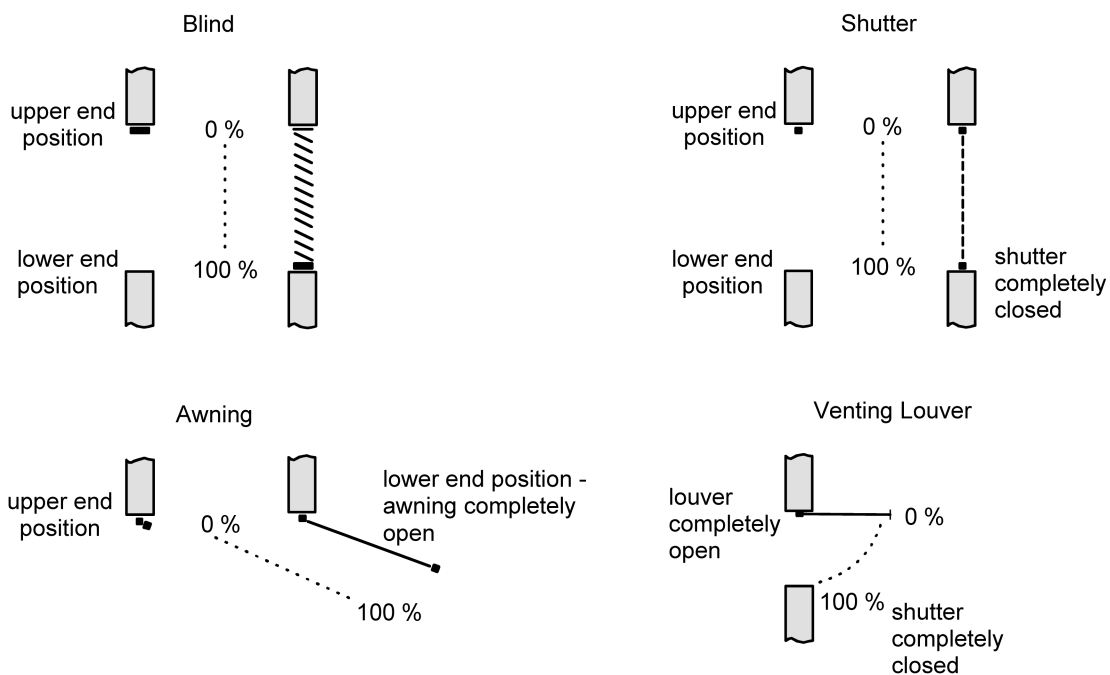

Image 9: Positions defined as a function of the type of movement

The actuator derives the positions from the configured travelling time since conventional drives do not provide feedback about their positions. Thus, the travel time configured or learned separately for each venetian blind output is the reference for all position approaches and of basic importance for the accuracy of the position calculations. For this reason, the travelling times should be determined with great accuracy in order to achieve the best possible positioning results.

For positioning purposes, the actuator calculates the movement time required as a function of the current position.

Example 1

The shutter connected to the certain output has an overall travel time of 20 s. The shutter is in its upper end position (0 %). It is to be positioned at 25 %. The actuator calculates the travel time required for approaching the desired position: $20 \text{ s} \cdot 0.25_{(25\%)} = 5 \text{ s}$. The output will then lower the shutter for 5 s and thus position the blind at height of 25 %.

Example 2

The shutter at an output has an overall travel time of 20 s. The shutter is in the 25 % position. It is to be positioned at 75 %. The difference between the positions is 50 %. The actuator calculates the travel time required for bridging the difference between the positions: $20 \text{ s} \cdot 0.5_{(50 \%)} = 10 \text{ s}$. The output will then lower the shutter for 10 s and thus position the blind at height of 75 %.

With all the upward movements, the configured movement time extension is automatically added to the calculated movement time.

Example 3

The shutter at an output has an overall travel time of 20 s. The shutter is in the 75 % position. It is to be positioned at 25 %. The difference between the positions is 50 %. The actuator calculates the non-extended travel time required for bridging the difference between the positions:

$20 \text{ s} \cdot 0.5_{(50 \%)} = 10 \text{ s}$. Taking the travel time extension into account (e.g. 10 %) the actual raising time is: $10 \text{ s} \cdot ((100 \% + 10 \%_{(\text{travel time extension})}) : 100 \%) = 10 \text{ s} \cdot 1.1 = 11 \text{ s}$. The output will then raise the shutter for 11 s and thus position it at a blind height of 25 %.

When the lower or upper end positions (0 % or 100 %) are approached, the movement time is always 20 % longer than the overall movement time.

Example 4

The shutter at an output has an overall travel time of 20 s. The shutter is in the 50 % position. It is to be positioned at 100 %. The difference between the positions is 50 %. The actuator calculates the travel time required for bridging the difference between the positions: $20 \text{ s} \cdot 0.5_{(50 \%)} = 10 \text{ s}$. As the movement is a limit position movement, the actuator adds 20 % of the total travel time:

$10 \text{ s} + (20 \% : 100 \%) \cdot 20 \text{ s} = 14 \text{ s}$. The output will then lower the shutter for 14 s and thus position it safely at a blind height of 100 %.

Example 5

The shutter at an output has an overall travel time of 20 s. The shutter is in the 50 % position. It is to be positioned at 0 %. The difference between the positions is 50 %. The actuator calculates the non-extended travel time required for bridging the difference between the positions: $20 \text{ s} \cdot 0.5_{(50 \%)} = 10 \text{ s}$. As the movement is a limit position movement, the actuator additionally adds 20 % of the total travel time:

$10 \text{ s} + (20 \% : 100 \%) \cdot 20 \text{ s} = 14 \text{ s}$.

Taking the travel time extension into account (e.g. 10 %) the actual raising time is: $14 \text{ s} \cdot ((100 \% + 10 \%_{(\text{travel time extension})}) : 100 \%) = 14 \text{ s} \cdot 1.1 = 15.4 \text{ s}$. The output will then raise the shutter for 15.4 s and thus position safely at 0 %.

- i** The actuator executes position approaches only if a new position deviating from the current position is preset.
- i** The actuator stores the blind or venting louver/roof window positions temporarily. The actuator can approach newly preset positions only if the current positions are known. For this purpose, each output must be given the op-

portdevicecy to synchronise itself whenever the bus voltage is switched on or after every ETS programming run (physical address, application program, partial download). This synchronisation is performed by means of a reference movement.

- i** Position approaches in progress will be aborted in case of bus voltage failure. In case of bus voltage failure, the configured behaviour will be executed.

Calculating the slat position (only with blinds)

In the "blinds" operating mode, the actuator always calculates the slat position so that the opening angle and thus the amount of light admitted into the room by the blind can be adjusted. A new position approach by a Venetian blind will always be followed by a positioning movement of the slats. Thus, the slat positions last selected will be tracked or readjusted to a new value if a position change has taken place.

In case of single-motor Venetian blind systems without a working position, the slats will be readjusted directly by a change of the Venetian blind height. For this reason, an adjustment of the slat position will always have an influence on the position of the blind itself .

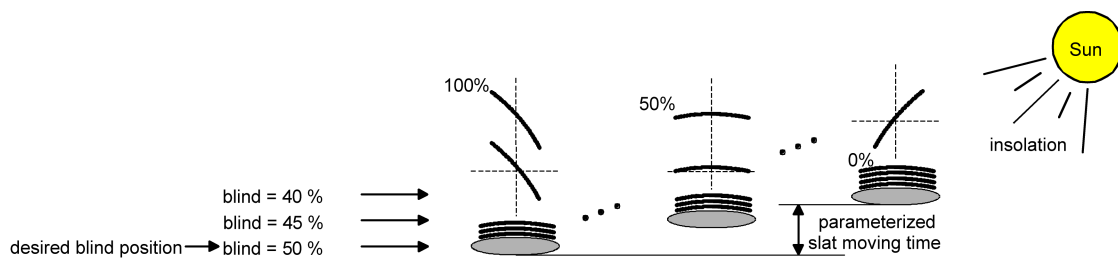

Image 10: Example of slat positioning affecting the position of the Venetian blind (typical of slat type 1; analogous reaction for type 2)

Since a preset slat position is to remain constant until the next change, the actuator will not change the height of the Venetian blind, if the calculated movement time required for a change of position lies within the configured slat moving time. Similarly, the actuator accounts for the ratio of the moving times of slat and Venetian blind and – in case of slat position changes – always recalculates the resulting Venetian blind position. If the position feedback objects are used (cf. "Position feedback"), the actuator transmits the blind positions changed by the adaptation also to the bus.

Example (see figure 10)

The Venetian blind position is preset to 50 %. A change of the slat angle (100 %...0 %) initiates the calculation of a new Venetian blind position which is also tracked in the position feedback objects. If the actuator is to approach a new blind position of, let's say 47 % in this case, the actuator will not perform a travel movement as the calculated travelling time lies within the parameterized slat moving time and therefore coincides with the slat movement. A change of the Venetian blind position to 55 % in this case triggers a Venetian blind movement as the change does not lie within the slat movement (0 to 100 %).

In each position operation, the Venetian blind setpoint position refers to a slat position of 100 %. In the event of a slat repositioning movement (0 to 100 %), the system will therefore report a Venetian blind position below the desired position.

Exception: The Venetian blind setpoint position of 0 % (upper end position) is assigned to the slat position of 0 %. The readjustment of the slat position will result also in this case in a change of the Venetian blind height (brief downward movement). Only in this case will the actuator report back a blind position above the desired blind position. With slat type 1, the slats are generally horizontal when the Venetian blind is in its upper end position. For this reason, the calculated slat position with a slat type 1 corresponds to the actual opening angle only after the first slat is completely extended (100%).

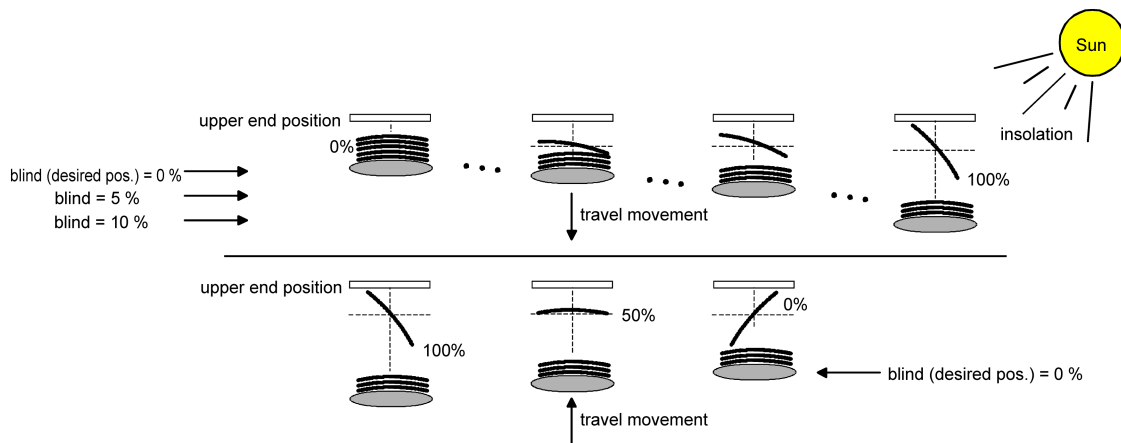

Image 11: Example of slat positioning with the Venetian blind in upper end position (typical of slat type 1.)

Example (see figure 11)

The Venetian blind position is preset to 0 %. After an extended movement, the Venetian blind is safely in the upper end position. A change of the slat angle (0 %...100 %) initiates the calculation of a new Venetian blind position which is also tracked in the position feedback objects. If the actuator is to approach a new blind position of, let's say 5 % in this case, the actuator will not perform a travel movement as the calculated travelling time lies within the parameterized slat moving time and therefore coincides with the slat movement. A change of the Venetian blind position to 15 % in this case triggers a Venetian blind movement as the change does not lie within the slat movement (0 to 100 %).

- i** The actuator executes slat position adjustments only if a new position deviating from the current slat position is preset.
- i** The actuator stores the slat positions temporarily. The actuator can approach newly preset slat positions only if the current position is known. For this purpose, each output must be given the opportunity to synchronise itself whenever the bus voltage is switched on or after every ETS programming run (physical address, application program, partial download). This synchronisation is performed by means of a reference movement for the slat or the Venetian blind.

- i** When positioning the Venetian blind height, the slats are always positioned afterwards. After reactivation of the bus voltage of after ETS programming, the actuator will in this case generally move the slats into the 100 % position, if no position has been preset for the slats.
- i** The smaller the ratio between slat moving time and Venetian blind travelling time, the more precise the position approaches and the less marked the influence of the slat angle adjustment on the height of the Venetian blind.

Presetting the position

The following ways of presetting positions can be distinguished...

- Direct positioning via the positioning objects (direct operation),
- Positioning by activating the sun protection function,
- Positioning using the response to bus voltage return,
- Positioning by a scene recall.

Positioning via the positioning objects:

Each Venetian blind, shutter, awning, venting louver or each roof window can be positioned directly using the Position ..." object" which is separate for each output. An independent positioning object exists for each of the slats. The position approached is always the position last received. The actuator does not show a reaction when the set or to be approached position value is received several times in succession.

This type of control is termed 'direct operation' just like operation via short time, long time or central objects or a scene recall. Positioning via the objects therefore has the same priority.

A position movement caused by the communication objects can be interrupted at any time by a long time command, short time command, central command or a scene recall. The direct operation can be overridden by a function with a higher priority, e.g. manual control, forced position, safety or also sun protection (configurable).

The position telegrams must correspond to the 1 byte data format according to KNX datapoint type 5.001 (Scaling). The actuator converts the value received (0...255) linearly into a position (0...100 %).

Received value (0...255)	Position derived from value (0...100 %)
0	0 % (upper end position / slat or venting louvre opened)
↓	↓ (all intermediate values rounded off to 1 % increments)
255	100 % lower end position / slat or louvre closed)

Data format of positioning objects with conversion into percentage position values

It is possible that new positioning telegrams are being received while a position approach is in progress. In this case, the actuator immediately reverses the direction of travel, if the new position to be approached lies in the opposite direction. If a slat pos-

itioning command is received during a running Venetian blind position approach, the device finishes first the Venetian blind position approach before positioning the slat. If a blind positioning command is received during a slat positioning movement, the actuator interrupts the slat positioning movement and approaches the new blind position. Only then does the actuator switch to the most recently received slat position.

In case of Venetian blind positioning, slat positioning will always be executed later. After switching on the bus voltage or after programming with the ETS, it may be the case that the slat position is unknown, if no long time command for the upward or downward movement with a duration of at least the configured slat moving time has been received or no slat positioning has taken place (no slat reference movement). In this case, the slat is moved during a Venetian blind position approach into the completely closed position (100 %). The slat position is then considered as calibrated.

- i** Optionally, the sun protection function offers the possibility of receiving the instruction of the blind height, venting louver/roof window position or slat position to be adopted during sunshine via separate communication objects and to pre-set these values variably. This form of variable position preset in the sun protection function is identical to presetting the positions via communication objects in direct operation. The priority of the incoming telegrams in direct operation with the sun protection activated can be additionally configured in the ETS.

Positioning by the sun protection function, the behaviour after bus voltage return or by a scene recall:

In case of the actuator functions mentioned, the positions to be approached are configured directly in the ETS depending on the operating mode. The position values can be specified between 0 % and 100 % in 1 % increments.

With Venetian blinds, the height of the Venetian blind is positioned first in these cases. The configured slat position is adjusted only thereafter.

- i** Important notes for all positioning movements: Using the connected drives frequently for position approaches (for instance several times a day) can result after some time in positioning inaccuracies. These deviations from the setpoint position are mostly due to external physical influences. To achieve accurate positioning in operation it is recommended to perform the reference movement at least once every day. This can be achieved for instance by a central raising command transmitted to the long time object.

Reference movement

After ETS programming (physical address, application program, partial download) or after bus voltage failure all current position data are unknown. Before the actuator can approach new positions after bus voltage return or after programming, the positioning system must at first be calibrated. A position calibration is possible by executing the reference movement.

A reference movement is the time required for a travel movement into the upper end position increased by 20 % and additionally by the configured travel time extension. A reference travel is not retriggerable.

Reference movements can be executed by the following commands...

- Uninterrupted long time operation (including also a terminated safety movement) into the upper end position activated via the corresponding communication object,
- an approach of the 0 % position,
- a manually controlled movement into the upper end position.

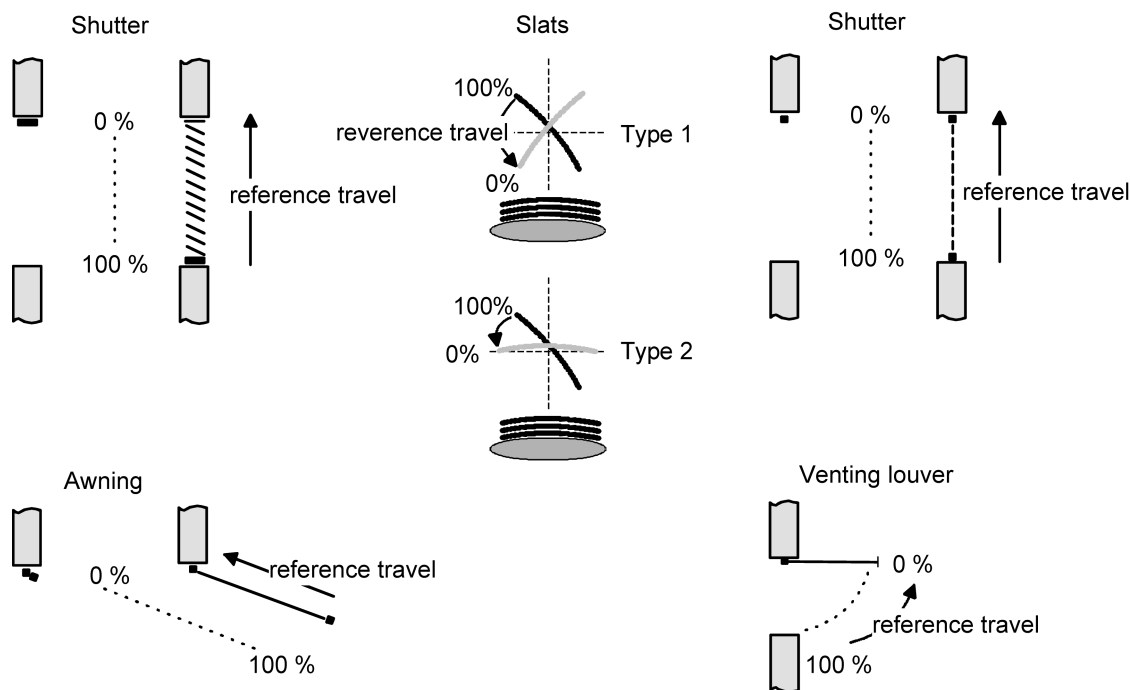

Image 12: Reference movement

In the event of slat positioning via the corresponding communication objects after bus voltage return or after programming, a slat reference movement becomes necessary if the Venetian blind has not been moved beforehand in the up or down directions for at least the configured slat moving time. During a slat reference movement, the actuator always moves the slats for the parameterized slat moving time into the completely open position (0 %) and then to the desired position. The slat position is also considered as calibrated when the Venetian blind has been moved by a long-time command in the up or down direction during at least the configured slat moving time.

- i** A terminated reference movement of the Venetian blind will also calibrate the slat position.
- i** If the reference movement is interrupted for instance by a short-time operation, the position is still unknown as before.
- i** A long-time travel into the lower end position activated via the corresponding communication object also calibrates the reference position.
- i** With the sun protection function it is moreover possible to force the actuator to perform a reference movement before each sun protection travel even if the positions are known. Thus, it is ensured that in case of sun protection the configured sun protection position is always precisely approached even after repeated position approaches.

- i** Using the connected drives frequently for position approaches (for instance several times a day) can result after some time in positioning inaccuracies. These deviations from the setpoint position are mostly due to external physical influences. To achieve accurate positioning in operation it is recommended to perform the reference movement at least once every day. This can be achieved for instance by a central raising command transmitted to the long-time object.

10.6.2 Feedback telegrams

Position feedback messages

In addition to presetting positions via positioning objects, the actuator can track the current positions values via separate feedback objects and also transmit them to the KNX, if the bus voltage is on. Thus, the preset setpoint position can be distinguished from the true actual position of the drives activated.

The following feedback telegrams can be preset for each output depending on the parameterized mode of operation...

- Feedback (1 byte) of the Venetian blind, shutter, awning or venting louver/roof window positions,
- Feedback (1 byte) of the slat position (only with Venetian blinds).

The individual position feedback messages can be enabled in the ETS independent of one another and have communication objects of their own. For each travel movement the actuator calculates the current position and tracks it in the position feedback objects. The positions are tracked and the feedback objects updated even when an output has been activated via short-time or long-time telegrams or by manual control on condition that the bus voltage is on.

The feedback objects are updated after the following events...

- at the end of a travel movement – including a slat positioning movement in a Venetian blind – when the drive stops and when the new position is reached,
- with a movement to an end position already at the time the end position is theoretically reached, i.e. before the 20 % extension and the travel time extension have elapsed,
- cyclically even during a travel movement, provided that cyclical transmission is active.

The feedback objects are not updated, if the position last reported back has not changed after a movement (for instance, when the Venetian blind is repositioned, the unchanged slat position will not be reported back a second time). The actuator cannot calculate a feedback position, if the current position data after switch-on of the bus voltage or after ETS programming are still unknown. In these cases, the system must first perform a reference movement so that the position can be calibrated. In case of unknown positions, the actuator automatically performs reference travels, if new positions are preset and if these positions are to be approached. As long as a position is unknown, the value of the feedback objects is "0".

Presetting position feedback for Venetian blind, shutter, awning or venting louver/roof window positions

The feedback functions can be enabled and programmed independently for each output. When feedback is enabled, the ETS adapts the parameter texts depending on the preset operating mode ("Venetian blind position feedback", "Shutter/awning position feedback" or "Venting louver/roof window position"). The feedback can be used as an active message object or as a passive status object. As an active signalling object, the position feedback information is transmitted to the bus whenever a position value changes. As a passive status object, there is no telegram transmission after a change. In this case, the object value must be read out. The ETS automatically sets the object communication flags required for proper functioning.

In case of an actively transmitting signalling object, the current position can be transmitted to the KNX after bus voltage return, if the position value differs from the one last transmitted. When the position data are known, the feedback telegram can in this case be transmitted with a time delay to reduce the bus load, with the delay being preset globally and in common for all outputs.

The feedback functions of an output must be enabled on the parameter page "Relay outputs... "Relay outputs... -> VBO... - General -> Enabled". Only then are the parameters for the feedback functions visible.

- Set the parameter "Venetian blind position feedback", "shutter/awning position feedback" or "Venting louver/roof window position" to "Feedback object is active signalling object".

The feedback object is enabled. The position value is transmitted as soon as it changes. No value will be actively transmitted, if the position is unknown.

- Set the parameter "Venetian blind position feedback", "shutter/awning position feedback" or "Venting louver/roof window position" to "Feedback object is active signalling object".

The feedback object is enabled. The position value will be transmitted in response only if the feedback object is read out from by the KNX. If the position is unknown, a value of "0" will be reported back after readout.

The feedback must be set as actively transmitting.

- If a delay after bus voltage return or after ETS programming should be necessary, activate the parameter "Time delay for feedback after bus voltage return" on the parameter page "

The position feedback is transmitted with a delay after bus voltage return or after an ETS programming operation, provided that the position is known (reference movement performed). After the end of the delay, the position last adjusted statically will be transmitted to the KNX. No feedback telegram is transmitted during a running delay, even if a position value changes during this delay.

The feedback must be set as actively transmitting.

- If cyclical transmission is required during active movement, activate the parameter of the same name and configure the required cycle time.

The position feedback is transmitted cyclically during a running travel movement. The parameter "Time for cyclical transmission" specifies the cycle time.

- i** The cyclical transmission only takes place if the position data is known (reference movement completed).
- i** If, after a bus voltage return or an ETS programming operation, the position data is unknown, the feedback objects are initialised with "0". The object values are then not transmitted to the KNX.
- i** In case of Venetian blind operation, any position change of the Venetian blind within the limits of the slat adjustment (0 to 100 %) does not cause a movement and therefore no change of the feedback position data either.

Presetting the position feedback for slat positions (only with Venetian blinds)

The feedback functions for the slat positions can be enabled and programmed independently for each output. As with the position feedback of the Venetian blind height, the feedback can be used as an active message object or as a passive status object. In case of an actively transmitting signalling object, the current slat position can be transmitted to the bus after bus voltage return, if the position value differs from the one last transmitted. When the position data are known, the feedback telegram can in this case be transmitted with a time delay to reduce the bus load, with the delay being preset globally and in common for all outputs.

The feedback functions of an output must be enabled on the parameter page "Relay outputs... "Relay outputs... -> VBO... - General -> Enabled". Only then are the parameters for the slat position feedback functions visible.

- Set the parameter "Slat position feedback" to "feedback object is active signalling object".
The feedback object is enabled. The position value is transmitted as soon as it changes. No value will be actively transmitted, if the position is unknown.
- Set the parameter "Slat position feedback" to "feedback object is passive status object".
The feedback object is enabled. The position value will be transmitted in response only if the feedback object is read out from by the KNX. If the position is unknown, a value of "0" will be reported back after readout.

The feedback must be set as actively transmitting.

- If a delay after bus voltage return or after ETS programming should be necessary, activate the parameter "Time delay for feedback after bus voltage return" on the parameter page ".
The position feedback is transmitted with a delay after bus voltage return or after an ETS programming operation, provided that the position is known (reference movement performed). After the end of the delay, the position last adjusted statically will be transmitted to the KNX. During a running delay the affected feedback object is updated but no feedback is transmitted actively, even if a position value changes during this delay.

The feedback must be set as actively transmitting.

- If cyclical transmission is required during active movement, activate the parameter of the same name and configure the required cycle time.

The position feedback is transmitted cyclically during a running travel movement. The parameter "Time for cyclical transmission" specifies the cycle time.

i The cyclical transmission only takes place if the position data is known (reference movement completed). The feedback object of the slat position also transmits cyclically during a blind/shutter movement (e.g. Venetian blind position approach).

i If, after a bus voltage return or an ETS programming operation, the position data is unknown, the feedback objects are initialised with "0". The object values are then not transmitted to the KNX.

i In case of Venetian blind operation, any position change of the Venetian blind within the limits of the slat adjustment (0 to 100 %) does not cause a movement and therefore no change of the feedback position data either.

'Unknown position' feedback and travel movement

In addition to position data feedback, the actuator can also report back enlarged 1-bit status information messages and transmit them actively to the KNX, if the bus voltage is on.

The following status feedback messages can be separately preset for each output...

- Feedback of an invalid position,
- Drive movement feedback,

Feedback of an invalid position:

After switch-on of the supply voltage or after programming with the ETS, all the position data of an output is unknown. In this case, the actuator can update the feedback object "Invalid position" (object value "ON"), which will then signal that the object values of the 1-byte position feedback objects are invalid.

An invalid position feedback will only be reversed (object value "OFF"), after the position data for the Venetian blind, shutter, awning, venting louver or roof window have been calibrated by means of a reference movement. The calibration of the slat position in a Venetian blind alone will not result in the reversal of an "invalid position".

As an option, the object value of the status feedback message can be actively transmitted to the KNX in case of a value change.

Drive movement feedback:

The actuator can report back via a separate 1-bit communication object per output whether the connected drive is moving, i.e. whether the output is supplying current for any travel direction. The feedback object has the object value "ON", when current is flowing from the output to the drive. Similarly, "OFF" is written into the object if the output concerned remains in a stop position. In this case, the operation by which the output was activated (short-time or long-time operation, positioning, manual control, etc.) is of no importance.

As an option, the object value of the status feedback message can be actively transmitted to the KNX in case of a value change.

The state of the feedback is only derived from the relay state of the actuator. This means that if a drive is blocked or already in its end position, the value reported back does not correspond to the actual state of the travel movement.

Setting feedback of an invalid position

The feedback of an invalid position can be enabled and programmed independently for each output. When feedback is enabled, the ETS adapts the parameter texts depending on the preset operating mode ("invalid Venetian blind position feedback", "invalid shutter/awning position feedback" or "invalid venting louver/roof window position").

The feedback can be used as an active message object or as a passive status object. As an active signalling object, the status feedback information is transmitted to the KNX whenever a position value changes. As a passive status object, there is no telegram transmission after a change. In this case, the object value must be read out. The ETS automatically sets the object communication flags required for proper functioning.

If the object is an actively transmitting signalling object, the feedback telegram can be transmitted after bus voltage return with a time delay to reduce the bus load, with the delay being preset globally and in common for all outputs.

The feedback functions of an output must be enabled on the parameter page "Relay outputs... "Relay outputs... -> VBO... - General -> Enabled". Only then are the parameters for the feedback functions visible.

- Set the parameter "invalid Venetian blind position feedback", "invalid shutter/awning position feedback" or "invalid venting louver/roof window position" to "Feedback object is active signalling object".

The feedback object is enabled. A telegram is transmitted as soon as there is a change (e.g. after ETS programming, after switch-on of the bus voltage or after a reference movement).

- Set the parameter "invalid Venetian blind position feedback", "invalid shutter/awning position feedback" or "invalid venting louver/roof window position" to "Feedback object is passive status object".

The feedback object is enabled. A telegram will be transmitted in response only if the feedback object is read out by the bus.

The feedback must be set as actively transmitting.

- If a delay after bus voltage return should be necessary, activate the parameter "Time delay for feedback after bus voltage return" on the parameter page "Relay outputs... -> VBO... - General -> Feedback telegrams".

The feedback of an invalid position will be transmitted with a delay after bus voltage return. After the end of the delay, the object value state last adjusted will be transmitted to the KNX. No feedback telegram is transmitted during a running delay, even if a position value becomes known during this delay, for example through a reference movement.

- i** Automatic transmission after bus voltage return only takes place if there has been an internal change to the object state (for example through a reference run during manual operation).

Setting drive movement feedback

The feedback of a drive movement can be enabled and programmed independently for each output. The feedback can be used as an active message object or as a passive status object. As an active signalling object, the status feedback information is transmitted to the KNX whenever a position value changes. As a passive status object, there is no telegram transmission after a change. In this case, the object value must be read out. The ETS automatically sets the object communication flags required for proper functioning.

If the object is an actively transmitting signalling object, the feedback telegram can be transmitted after bus voltage return with a time delay to reduce the bus load, with the delay being preset globally and in common for all Venetian blind outputs.

The feedback functions of an output must be enabled on the parameter page "Relay outputs..." "Relay outputs... -> VBO... - General -> Enabled". Only then are the parameters for the feedback functions visible.

- Set the parameter "Slat position feedback" to "Feedback object is active signalling object".
The feedback object is enabled. A telegram is transmitted when the connected drive starts moving or stops.
- Set the parameter "Slat position feedback" to "Feedback object is passive status object".
The feedback object is enabled. A telegram representing the current travel movement will be transmitted in response only if the feedback object is read out by the KNX.

The feedback must be set as actively transmitting.

- If a delay after bus voltage return should be necessary, activate the parameter "Time delay for feedback after bus voltage return" on the parameter page "Relay outputs... -> VBO... - General -> Feedback telegrams".
The feedback of a travel movement is transmitted after a delay on bus voltage return, for example, when the drive starts moving on account of the set behaviour after bus voltage return. After the end of the delay, the object value state last adjusted will be transmitted to the KNX. No feedback is transmitted during a running delay, even if the drive stops or starts moving.

- i** Automatic transmission only takes place after a bus voltage return when the drive starts moving on bus voltage return or if the bus failure has caused a change to the travel movement.

10.6.3 Parameter position calculation, position presetting and feedbacks

Relay outputs... -> VBO... - General -> Enabled functions

Feedback telegrams	Checkbox (yes / no)
This parameter can be used to enable the feedback functions of the Venetian blind output.	

Relay outputs... -> VBO... - General -> Feedback telegrams

Venetian blind position	no feedback feedback object is active signalling object feedback object is passive status object
<p>The current Venetian blind position of the output can be reported separately back to the KNX.</p> <p>no feedback: There is no feedback object available for the output. feedback deactivated</p> <p>Feedback object is an active signalling object: The feedback and the object are activated. The object transmits actively.</p> <p>Feedback object is a passive status object: The feedback and the object are activated. The object is passive (telegram transmission only as a response to 'Read' request).</p> <p>This parameter is only visible in the venetian blind operating mode.</p>	

Position of shutter/awning	no feedback feedback object is active signalling object feedback object is passive status object
<p>The current roller shutter or awning position of the output can be reported separately back to the KNX.</p> <p>no feedback: There is no feedback object available for the output. feedback deactivated</p> <p>Feedback object is an active signalling object: The feedback and the object are activated. The object transmits actively.</p> <p>Feedback object is a passive status object: The feedback and the object are activated. The object is passive (telegram transmission only as a response to 'Read' request).</p> <p>This parameter is only visible in the shutter/awning operating mode.</p>	

Venting louver/roof window positions	no feedback feedback object is active signalling object feedback object is passive status object
<p>The current venting louver/roof window positions of the output can be reported separately back to the KNX.</p> <p>no feedback: There is no feedback object available for the output. feedback deactivated</p> <p>Feedback object is an active signalling object: The feedback and the object are activated. The object transmits actively.</p> <p>Feedback object is a passive status object: The feedback and the object are activated. The object is passive (telegram transmission only as a response to 'Read' request).</p> <p>This parameter is only visible in the "venting louver/roof window" operating mode.</p>	

Delay after bus voltage return	Checkbox (yes / no)
<p>The feedback telegram can be transmitted to the KNX with a delay after bus voltage return or after programming with the ETS. The delay time is configured under "General -> General Venetian blind outputs".</p> <p>This parameter is only visible in case of an actively transmitting feedback object.</p>	

Cyclical transmission during active movement	Checkbox (yes / no)
<p>If cyclical transmission of the blind/shutter position is required during active movement, this parameter can be activated. The position feedback is then transmitted cyclically during a running travel movement. The cyclical transmission only takes place if the position data is known (reference movement completed).</p> <p>This parameter is only visible in case of an actively transmitting feedback object.</p>	

Time for cyclical transmission seconds	2...5...59
<p>This parameter specifies the cycle time for the cyclical transmission of the blind/shutter position and is only available if cyclical transmission is activated.</p>	

Slat position	no feedback feedback object is active signalling object feedback object is passive status object
<p>The current slat position of the output can be reported separately back to the KNX.</p> <p>no feedback: There is no feedback object available for the output. feedback deactivated</p> <p>Feedback object is an active signalling object: The feedback and the object are activated. The object transmits actively.</p> <p>Feedback object is a passive status object: The feedback and the object are activated. The object is passive (telegram transmission only as a response to 'Read' request).</p> <p>This parameter is only visible in the venetian blind operating mode.</p>	

Delay after bus voltage return	Checkbox (yes / no)
<p>The feedback telegram can be transmitted to the KNX with a delay after bus voltage return or after programming with the ETS. The delay time is configured under "General -> General Venetian blind outputs".</p> <p>This parameter is only visible in case of an actively transmitting feedback object.</p>	
Cyclical transmission during active movement	Checkbox (yes / no)
<p>If cyclical transmission of the slat position is required during active movement, this parameter can be activated. The position feedback is then transmitted cyclically during a running travel movement. The feedback object of the slat position also transmits cyclically during a blind/shutter movement (e.g. Venetian blind position approach). The cyclical transmission only takes place if the position data is known (reference movement completed).</p> <p>This parameter is only visible in case of an actively transmitting feedback object.</p>	
Time for cyclical transmission seconds	1...59
<p>This parameter specifies the cycle time for the cyclical transmission of the slat position and is only available if cyclical transmission is activated.</p>	
Invalid Venetian blind position	<p>no feedback</p> <p>feedback object is active signalling object</p> <p>feedback object is passive status object</p>
<p>The actuator can report to the KNX that the current blind position is unknown (e.g. after an initialisation, when no reference travel has been executed as yet).</p> <p>no feedback: There is no feedback object available for the output. feedback deactivated</p> <p>Feedback object is an active signalling object: The feedback and the object are activated. The object transmits actively.</p> <p>Feedback object is a passive status object: The feedback and the object are activated. The object is passive (telegram transmission only as a response to 'Read' request).</p> <p>This parameter is only visible in the venetian blind operating mode.</p>	

Invalid shutter/awning position	no feedback feedback object is active signalling object feedback object is passive status object
<p>The actuator can report to the KNX that the current roller shutter/awning position is unknown (e.g. after an initialisation, when no reference travel has been executed as yet).</p> <p>no feedback: There is no feedback object available for the output. feedback deactivated</p> <p>Feedback object is an active signalling object: The feedback and the object are activated. The object transmits actively.</p> <p>Feedback object is a passive status object: The feedback and the object are activated. The object is passive (telegram transmission only as a response to 'Read' request).</p> <p>This parameter is only visible in the shutter/awning operating mode.</p>	

Invalid venting louver/roof window position	no feedback feedback object is active signalling object feedback object is passive status object
<p>The actuator can report to the KNX that the current venting louver/roof window position is unknown (e.g. after an initialisation, when no reference travel has been executed as yet).</p> <p>no feedback: There is no feedback object available for the output. feedback deactivated</p> <p>Feedback object is an active signalling object: The feedback and the object are activated. The object transmits actively.</p> <p>Feedback object is a passive status object: The feedback and the object are activated. The object is passive (telegram transmission only as a response to 'Read' request).</p> <p>This parameter is only visible in the "venting louver/roof window" operating mode.</p>	

Delay after bus voltage return	Checkbox (yes / no)
<p>The feedback telegram can be transmitted to the KNX with a delay after bus voltage return or after programming with the ETS. The delay time is configured under "General -> General Venetian blind outputs".</p> <p>This parameter is only visible in case of an actively transmitting feedback object.</p>	

Drive movement feedback	<p>no feedback</p> <p>feedback object is active signalling object</p> <p>feedback object is passive status object</p>
<p>The actuator can report to the KNX that the connected drive is active, i.e. the output is supplying power to the drive for a travel direction.</p> <p>no feedback: There is no feedback object available for the output. feedback deactivated</p> <p>Feedback object is an active signalling object: The feedback and the object are activated. The object transmits actively.</p> <p>Feedback object is a passive status object: The feedback and the object are activated. The object is passive (telegram transmission only as a response to 'Read' request).</p>	
Delay after bus voltage return	Checkbox (yes / no)
<p>The feedback telegram can be transmitted to the KNX with a delay after bus voltage return or after programming with the ETS. The delay time is configured under "General -> General Venetian blind outputs".</p> <p>This parameter is only visible in case of an actively transmitting feedback object.</p>	

10.6.4 Object list position calculation, position presetting and feedbacks

Object no.	Function	Name	Type	DPT	Flag
22, 46...	Position...	Venetian blind... - Input	1 bytes	5,001	C, (R), W, -, A

1-byte object for presetting a position value (0...255) for the height of the Venetian blind or shutter or the venting louver/roof window position in direct operation.

Object no.	Function	Name	Type	DPT	Flag
23, 47...	Slat position	Venetian blind... - Input	1 bytes	5,001	C, (R), W, -, A

1-byte object for presetting a slat position value (0...255) in direct operation.

Object no.	Function	Name	Type	DPT	Flag
38, 62...	Feedback ...position	Venetian blind... - Output	1 bytes	5,001	C, R, -, T, A

1-byte object for position feedback of the Venetian blind or shutter height or venting louver/roof window position (0...255).

Object no.	Function	Name	Type	DPT	Flag
39, 63...	Slat position feedback	Venetian blind... - Output	1 bytes	5,001	C, R, -, T, A

1-byte object for position feedback of the slat position (0...255) if one shutter is controlled.

Object no.	Function	Name	Type	DPT	Flag
40, 64...	Invalid position feedback	Venetian blind... - Output	1-bit	1,002	C, R, -, T, A

1-bit object for reporting back an invalid position of the Venetian blind or roller shutter height or louver position ("0" = position valid / "1" = position invalid).

Object no.	Function	Name	Type	DPT	Flag
41, 65...	Drive movement feedback	Venetian blind... - Output	1-bit	1,002	C, R, -, T, A

1-bit object for feedback of an active travel movement (output energised - UP or DOWN).
("0" = no drive movement / "1" = drive movement).

10.7 Safety functions

The actuator can handle up to five different safety functions:

3 x wind alarm, 1 x rain alarm, 1 x frost alarm. Each safety function has a communication object of its own so that the functions can be activated or deactivated independently of one another. The safety functions are programmed and configured in common for all shutter/blind outputs.

The different outputs of the actuator can be separately assigned to all or to individual safety functions. Only assigned outputs respond to a change in the state of the safety objects. The reactions at the beginning of an alarm ("ON" telegram) can be configured for each alarm separately whereas the reaction at the end of an alarm ("OFF" telegram) can be configured in common for all alarms.

An output can be assigned independently to the wind alarms, the rain alarm and the frost alarm. If an output is associated with several alarms, the preset priority decides which of the alarms will prevail and be executed. In so doing, an alarm with a higher priority overrides the alarms with the lower priorities. When safety alarm with the higher priority has ended, the safety alarm with the lower priority is executed on condition that it is active.

The order of priority of the wind alarms with respect to the frost alarm or to the rain alarm can be configured for several channels on the parameter page

"General -> General Venetian blind outputs". The three wind alarms have the same priority with respect to one another (logic OR). The last telegram update to the wind alarm objects decides which of the wind alarms will be executed. The wind alarm is completely deactivated only after all three objects are inactive ("OFF").

An output in the active safety alarm state is locked, i.e. the control of the output concerned via the KNX by direct operation (short-time, long-time telegram, scenes, positioning, central) or by a sun protection function is prevented. Only a forced position and a manual control locally on the device itself have a higher priority so that these functions may override a safety interlock. At the end of a forced position or of a manual control, the safety reaction is re-executed if an assigned safety alarm is still active.

Assigning safety alarms

The individual safety alarms can be assigned separately for each output. The channels are assigned on the parameter page

"Relay outputs... -> VBO... - General -> Safety".

The safety functions must be globally enabled on the "General blind outputs -> Safety" parameter page before the output assignments are configured.

The safety function of an output must be enabled on the parameter page "Relay outputs... -> VBO... - General -> Enabled". Only then are the channel-related parameters for the safety function visible.

- If an assignment to the wind alarms is necessary, activate the parameter "Assignment to wind alarm X" (X = 1...3).

The output is assigned to the specified wind alarms.

- If an assignment to the rain alarm is necessary, activate the parameter "Assignment to rain alarm".
The output is assigned to the rain alarm.
- If an assignment to the frost alarm is necessary, activate the parameter "Assignment to frost alarm".
The output is assigned to the frost alarm.

Presetting the behaviour at the beginning of a safety alarm

The behaviour of an output at the beginning of a safety alarm can be parameterized separately for each alarm (wind alarms in common, rain and frost alarms separately). The alarm behaviour is preset on the parameter page "Relay outputs... -> VBO... - General -> Safety". At the beginning of a safety alarm, the actuator locks the outputs concerned, i.e. control via the KNX by direct operation (short time, long time telegram, scenes, positioning) or by a sun protection function is prevented.

Depending on the selected operating mode, the ETS adapts the designations of the parameter settings ("raising" ↔ "opening" / "lowering" ↔ "closing").

The safety functions must be globally enabled on the parameter page "General -> General Venetian blind outputs".

The safety function of an output must be enabled on the parameter page "Relay outputs... -> VBO... - General -> Enabled". Only then are the channel-related parameters for the safety function visible.

The behaviour in case of a safety alarm can only be adjusted, if the output concerned has been assigned to the corresponding alarm. Since there is no difference between the alarm-dependent configurations, the selection of the parameters is only described below for the wind alarm as an example.

- Set the parameter "For wind alarm" to "no reaction".
At the beginning of the alarm, the output is locked and the relay of the output shows no reaction. Any movements still in progress at this instant will still be completely finished.
- Set the parameter "For wind alarm ..." to "raising" or "opening".
The actuator raises the blind/shutter or opens the venting louver/roof window at the beginning of the alarm and then locks the output.
- Set the parameter "For wind alarm ..." to "lowering" or "closing".
The actuator lowers the blind/shutter or closes the venting louver/roof window at the beginning of the alarm and then locks the output.
- Set the parameter "For wind alarm ..." to "stop".
At the beginning of the alarm, the actuator switches the relays of the output to "stop" and locks the output. A travel movement, if any, will be interrupted.

- i** The safety travel time required by an output to move the drive into the end positions is determined by the parameter "Travel time" on the parameter page "Relay outputs... -> VBO... - General -> Times". Like the long-time operation, a safety movement is derived from the movement time. Downward movement: movement time + 20 %; Upward movement: movement time + 20 % + configured movement time extension. Safety movements are not retriggerable.
- i** Slats of blinds are not repositioned at the end of safety movements to end positions.

Setting the behaviour at the end of all safety alarms

The actuator ends the safety interlock of an output only after all safety alarms assigned to the output have become inactive. Afterwards, the output concerned shows the configured "End of safety". The behaviour is configured on the parameter page "Relay outputs... -> VBO... - General -> Safety" in common for all alarms.

Depending on the selected operating mode, the ETS adapts the designations of the parameter settings ("raising" ↔ "opening" / "lowering" ↔ "closing").

The safety functions must be globally enabled on the parameter page "General -> General Venetian blind outputs".

The safety function of an output must be enabled on the parameter page "Relay outputs... -> VBO... - General -> Enabled". Only then are the channel-related parameters for the safety function visible.

- Set the parameter "end of safety" to "no reaction".
At the end of all safety alarms, the output is released and the relay of the output shows no reaction. Any travel movements still in progress at this instant will still be finished.
- Set the parameter "end of safety" to "raising" or "opening".
The actuator enables the output at the end of all safety alarms and raises the blind/shutter or opens the venting louver/roof window.
- Set the parameter "end of safety" to "lowering" or "closing".
The actuator enables the output at the end of all safety alarms and lowers the blind/shutter or closes the venting louver/roof window.
- Set the parameter "end of safety" to "stop".
At the end of all safety alarms, the output is released and the actuator switches the relays of the output to "stop". A travel movement, if any, will be interrupted.
- Set the parameter "end of safety" to "tracking the position".
At the end of all safety alarms, the output will be set to the state last adjusted statically before the safety function or to the state tracked and internally stored during the safety function. The position objects, the long-time object and the scene function are tracked.

- i** Parameter setting "Position tracking": The actuator can track absolute positions after safety release (position telegram, scene value) only if the position data are known and if the positions have been predefined. In all other cases, no reaction takes place on release of safety.

Position data can be tracked, if the output was in a defined position before the safety function or if a new position telegram was received via the position objects during the safety interlock. In the latter case, a reference movement will be executed when the safety function is enabled, if the position before or during the safety interlock was unknown.

Known slat positions will also be tracked as described. This is also the case, when the height of the Venetian blind is unknown.

Long time movements (movements without position preset) will, however, always be tracked.

- i** The preset "Behaviour at the "end of safety" will only be executed, if the output passes over to direct operation at the end of all safety alarms. If a sun protection function is activated (independent of the preset priority with respect to direct operation), it will be also executed.

10.7.1 Safety functions parameter

Relay outputs... -> VBO... - General -> Enabled functions

Safety functions	Checkbox (yes / no)
This parameter can be used to enable the Venetian blind output.	

Relay outputs... -> VBO... - General -> Safety

Assignment to wind alarm 1	Checkbox (yes / no)
This parameter defines whether the Venetian blind output responds to the first wind alarm.	

Assignment to wind alarm 2	Checkbox (yes / no)
This parameter defines whether the Venetian blind output responds to the second wind alarm.	

Assignment to wind alarm 3	Checkbox (yes / no)
This parameter defines whether the Venetian blind output responds to the third wind alarm.	

For wind alarm	no reaction raising / opening lowering / closing stop
<p>This parameter defines the behaviour of the output at the beginning of a wind alarm.</p> <p>no reaction: At the beginning of the wind alarm or wind alarms, the output is interlocked and the relay of the output shows no reaction. Any movements in progress at this instant will still be completely finished.</p> <p>raising / opening: The actuator raises the blind/shutter or opens the venting louver/ roof window at the beginning of the wind alarm or wind alarms and then locks the output.</p> <p>lowering / closing: The actuator lowers the blind/shutter or closes the venting louver/ roof window at the beginning of the wind alarm or wind alarms and then locks the output.</p> <p>stop: At the beginning of the wind alarm or wind alarms, the actuator switches the relays of the output to the "stop" position and locks the output. A travel movement, if any, will be interrupted.</p> <p>This parameter is only visible if the output has been assigned to at least one wind alarm.</p>	

Assignment to rain alarm	Checkbox (yes / no)
This parameter defines whether the output responds to the rain alarm.	

For rain alarm	no reaction raising / opening lowering / closing stop
<p>This parameter defines the behaviour of the output at the beginning of the rain alarm.</p> <p>no reaction: At the beginning of the rain alarm, the output is locked and the relay of the output shows no reaction. Any movements in progress at this instant will still be completely finished.</p> <p>raising / opening: The actuator raises the blind/shutter or opens the venting louver/ roof window at the beginning of the rain alarm and then locks the output.</p> <p>lowering / closing: The actuator lowers the blind/shutter or closes the venting louver/ roof window at the beginning of the rain alarm and then locks the output</p> <p>stop: At the beginning of the rain alarm, the actuator switches the relays of the output to the "stop" position and locks the output. A travel movement, if any, will be interrupted.</p> <p>This parameter is only visible, if the output has been assigned to the rain alarm.</p>	
Assignment to frost alarm	Checkbox (yes / no)
This parameter defines whether the output responds to the frost alarm.	
For frost alarm	no reaction raising / opening lowering / closing stop
<p>This parameter defines the behaviour of the output at the beginning of the frost alarm.</p> <p>no reaction: At the beginning of the frost alarm, the output is interlocked and the relay of the output shows no reaction. Any movements in progress at this instant will still be completely finished.</p> <p>raising / opening: The actuator raises the blind/shutter or opens the venting louver/ roof window at the beginning of the frost alarm and then locks the output.</p> <p>lowering / closing: The actuator lowers the blind/shutter or closes the venting louver/ roof window at the beginning of the frost alarm and then locks the output</p> <p>stop: At the beginning of the frost alarm, the actuator switches the relay of the output to the "stop" position and locks the output. A travel movement, if any, will be interrupted.</p> <p>This parameter is only visible, if the output has been assigned to the frost alarm.</p>	

End of safety (wind, rain, frost)	no reaction raising / opening lowering / closing stop tracking the position
<p>This parameter defines the behaviour of the output at the end of all safety functions.</p> <p>no reaction: At the end of the safety functions, the output is enabled and the relay of the output shows no reaction. Any travel movements still in progress at this instant will still be finished.</p> <p>raising / opening: The actuator enables the output at the end of all safety alarms and raises the blind/shutter or opens the venting louver/roof window.</p> <p>lowering / closing: The actuator enables the output at the end of the safety functions and lowers the blind/shutter or closes the venting louver/roof window.</p> <p>stop: At the end of the safety functions, the output is enabled and the actuator switches the relays of the output to the "stop" position. A travel movement, if any, will be interrupted.</p> <p>tracking the position: At the end of safety, the output will be set to the state last adjusted before the safety function or to the state tracked and internally stored during the safety function. The position objects, the long-time object and the scene function are tracked.</p> <p>The behaviour preset in this parameter will only be executed, if the output passes over to direct operation at the end of safety. Direct operation will be executed when a sun protection function is active.</p>	

10.7.2 Object list safety functions

The safety functions only have global communication objects that are used for all Venetian blind outputs (siehe Kapitel "Object list safety functions" ▶ Page 45).

10.8 Sun protection function

Introduction

Each venetian blind output of the actuator can be separately configured for the execution of a sun protection function. Sun protection is generally realized with blinds, shutters or awnings and offers an intelligent method of shading rooms, terraces or balconies during sunshine depending on the altitude of the sun in the sky and on the intensity of the sunlight

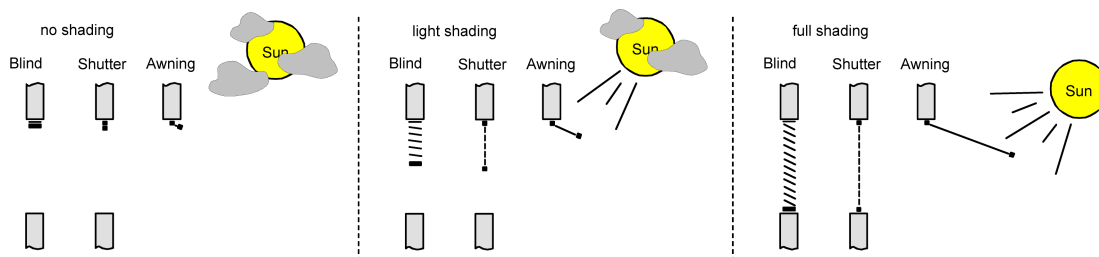

Image 13: Sun protection principles (example)

The sun protection functions of the actuator can be adapted many different applications. In simple applications as, for instance, in case of direction-dependent measurement of the sun's intensity by means of a brightness sensor, the curtains controlled can be closed partly or completely to prevent being disturbed by direct sunlight. In these applications, the sun protection function merely evaluates the 1-bit sun signal from the brightness or a similar sensor (e.g. weather station with limit value monitoring) and makes a drive open or close the controlled curtains by moving them into fixed configured positions or into variable positions preset via the bus.

In extended applications – for instance where the degree of shading is controlled by weather stations evaluating additionally the sun angle as a function of astro co-ordinates and presetting the blind and also the slat positions dynamically – the sun protection function can be supplemented by an automatic control system. In such applications, the sun protection function evaluates additional KNX communication objects, which can be used to enable or disable the automatic control while the actuator is in operation. This results in a large number of combination variants with intelligent Venetian blind control systems.

Already simple sun protection applications are sufficient to permit a fixed or variable re-adjustment of the positions of Venetian blind slats for adapting the curtain to individual shading requirements. For this purpose, it is possible to set a static slat offset in the ETS configuration, for instance, for adapting the reflection of sunlight depending on the building situation, or additionally, via a KNX communication object, e.g. for manual re-adjustment of the slat opening by people in the room or otherwise by a central building services control system.

In all cases, the priority between an incoming sunshine or automatic telegram and the direct operation of an output (short-time, long-time telegram, scenes, positioning, central) can also be preset in the ETS. This way, a sun protection position can, for instance, be influenced by a manual operation of a touch sensor in the room and the sun protection function be interrupted. Alternatively, sun protection mode can therefore not be interrupted by a direct operation, i.e. the output is locked.

A sun protection function can be overridden by a safety function, a forced position or also by a manual control locally on the device itself, as these functions of the actuator invariably have a higher priority. At the end of one of the mentioned functions with a higher priority, the same reaction as the one at the beginning of sun protection will be re-executed, if the sun protection function is still active at this time.

The actuator can be operated with two sun protection functions. The simple sun protection or alternatively the extended sun protection that can be enabled.

Simple sun protection

In simple sun protection, shading against sunlight is activated and deactivated via the 1-bit communication object "Sunshine". The polarity of this object can be selected in the ETS. The sun protection is activated as soon as "sunshine" is signalled to the object depending on the preset polarity. After ETS programming or after switch-on of the supply voltage, the object must at first have data written into it by the KNX also in case of inverted polarity before the sun protection can be activated.

A newly received object value (sunshine beginning or sunshine end) can optionally be evaluated with a time delay. This feature permits suppressing brief brightness variations caused, for instance, by passing clouds or by a thunderstorm. An update (from activated to activated) of the "Object "sunshine" causes the sun protection to be reactivated if it had been influenced and possibly re-enabled beforehand by a direct operation in acc. with the preset priority.

The reaction of a specific output at the beginning of shading can be preset in the ETS. Amongst other things, this setting permits approaching fixed configured positions or positions preset via the KNX and thus variable. Variable positions for sun protection purposes can be preset, for instance, by means of pushbutton sensors or visualisations. In addition, it is possible in case of a defined sun protection positioning movement to have a reference travel executed by forced control. This ensures that identical blind positions are approached synchronously by different outputs in case of a sun protection positioning movement.

The reaction at the end of a shading task can be preset as well. In this situation, the curtain can pass into an end position, be stopped or shown no special reaction. Tracking of positions is possible as well.

A priority setting in the ETS configuration makes it possible to specify whether the sun protection function can be influenced by direct operation or whether the corresponding output is locked by a telegram "Sunshine" in the sun protection position. Basically, the "Manual control", "Forced position" and "Safety" functions have a higher priority so that these functions can override, but not terminate a sun protection. Thus, the sun protection function is re-executed at the end of a function with a higher priority, if the Object "sunshine" continues to signal the presence of sunshine.

- i** The following rules must be observed for the extended sun protection: After an ETS programming operation, the sun protection function including automatic operation is always deactivated.

The schematic diagram of the simple sun protection and an example of how sensor components can be integrated into a simple sun protection configuration.

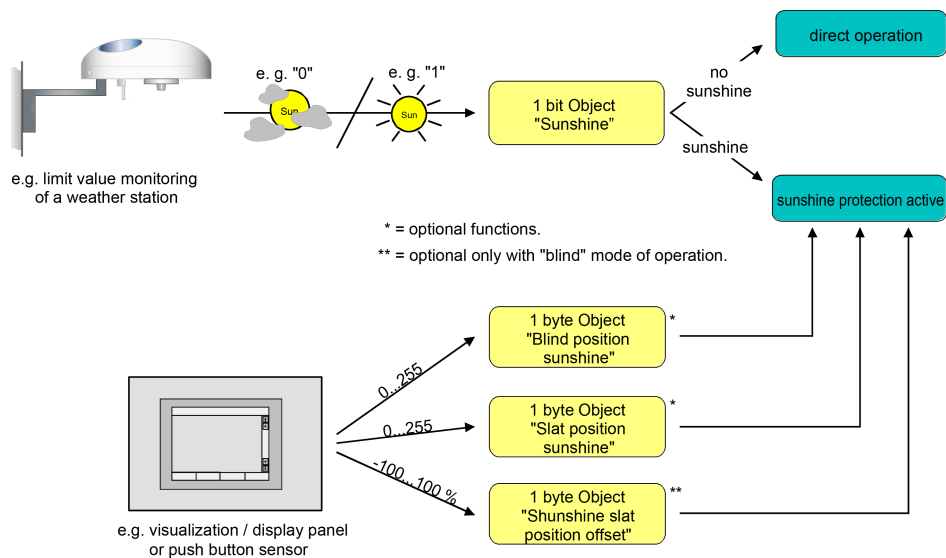

Image 14: Schematic diagram illustrating the simple sun protection configuration

The function diagram shows all possible functions of the simple sun protection. For reasons of clarity, the functions with a higher priority (manual control, forced position, safety function) are not shown in the diagram.

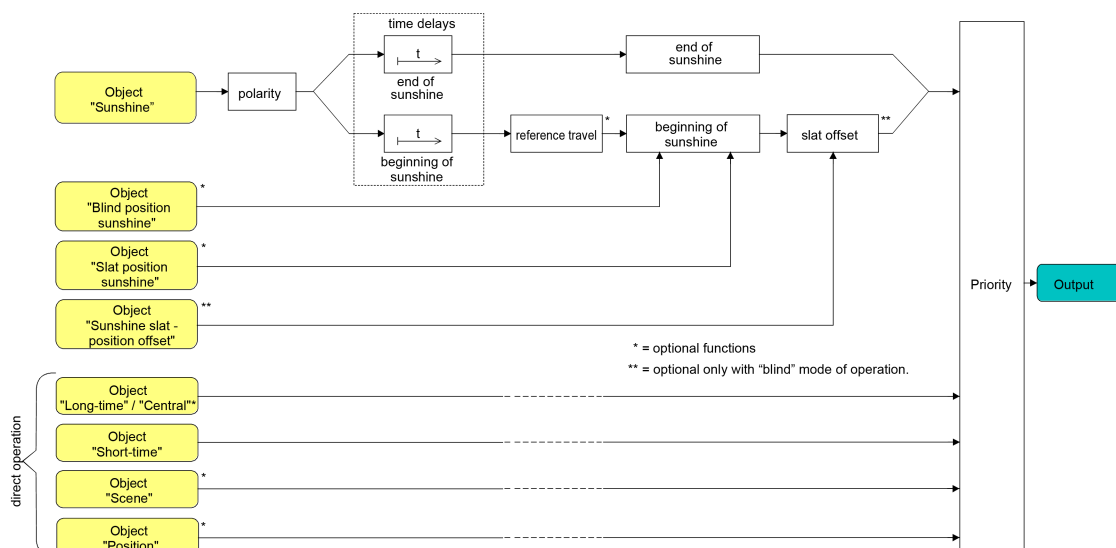

Image 15: Function diagram illustrating the simple sun protection

Extended sun protection

The extended sun protection has the basic functional properties of the simple sun protection function. In addition, an automatic control system can be implemented. Venetian blind control systems for blind/shutter and slat position tracking with respect to the position of the sun, like for example, a weather station, can therefore be integrated into the actuator via the bus as an added automatic function.

In extended sun protection, shading against sunlight is activated and deactivated via the 1-bit communication object "Sunshine". A reaction of the output to the sun telegram can be expected only after the automatic control has been activated. In all other cases, the sun protection function is completely deactivated.

As far as the activation of the automatic control via the corresponding object is concerned, the following two cases must be distinguished...

- Sun shading action starting immediately:
Automatic operation is activated as soon as the object "automatic- sun protection" receives an "ON"-Telegram. The output reacts immediately to the activation and shows the preset behaviour depending on the sunlight condition (sunshine / beginning or end of sunshine). The sunlight conditions are derived from the object "sunshine" according to the set polarity - possibly after the delays have elapsed.
After an ETS programming operation or after switch-on of the supply voltage, the "sunshine" object is initialised with "OFF" and, unlike the simple sun protection, evaluated immediately depending on the preset polarity so that shading against sunlight can begin immediately on activation of the automatic sun protection function. The reception of an "OFF"-telegram by the "automatic sun protection" object always terminates an automatic operation independent of the state of the "sunshine" object.

Application example

Private house with conservatory. The conservatory is equipped with Venetian blinds to shade the place against sunlight. When the conservatory is used, automatic operation is activated, for instance, with a push-button sensor on the wall. The actuator then immediately executes the shading function, if sunshine was detected. The actuator then carries out the configured behaviour at the end of Sunshine if no sunshine was detected on activating Automatic operation.

- Activation of the sun shading only on the next update:
In this configuration, the polarity of the automatic object can be preset. Automatic operation is activated as soon as the "Automatic sun protection" object is set to 'active' in accordance with polarity. A reaction at the output occurs, however, only after a new change of state has been signaled via "Sunshine"("OFF"-> "ON" or "ON" -> "OFF"). In this case, the new sunlight condition (beginning of sunshine or end of sunshine) determines the behaviour of the output immediately depending on the preset polarity.
After an ETS programming operation or after switch-on of the supply voltage, the "automatic sun protection" object must at first have data written into it by the bus also in case of inverted polarity before the automatic operation can be activated.
The reception of an "automatically deactivated" telegram by the "automatic sun protection" object always terminates an automatic operation independent of the state of the "sunshine" object.

Application example

An office building is equipped with several Venetian blinds to shade individual offices against sunlight. In the early morning hours, the automatic sun protection is activated in a central place in the building, e.g. in the porter's lodge. The Venetian blinds will, however, not move into the shading positions unless the system has actually reported sunshine for the building facades in question.

The behaviour at the end of automatic operation is configured separately in the ETS and is executed whenever the automatic mode is terminated and when no function with a higher or equal priority is active at this time. In this situation, the curtain can pass into an end position, be stopped or shown no special reaction. Tracking of positions is possible as well.

Disabling functions of the extended sun protection:

In the event of the sun shading action starting immediately, the automatic operation can optionally be disabled with an additional communication object. The objects "automatic sun protection" and "sun protection - automatic mode disable" are logically combined (AND with feedback). When disabling is activated, the automatic operation is reset and thus aborted. The output concerned will then show the behaviour at the end of automatic operation. The automatic mode can only be reactivated, if the disabling object is enabled and if the "automatic sun protection" object is updated again by writing an "ON" into it. Any attempt to activate the automatic mode while a disable is active will be ignored.

Automatic operation disabling example

An office room is equipped with Venetian blinds to shade the room against sunlight. The room is moreover equipped with a push-button sensor on the wall with which the automatic operation can be activated or also deactivated. When the automatic mode is activated, the room is immediately shaded against sunlight, if necessary. Depending on the time of day or in the event of disturbing sunlight falling into the room, the people in the room can therefore decide for themselves whether automatic shading is desired or not.

If required, the automatic sun protection is disabled in a central place of the building, for instance, in the porter's lodge. The automatic control of the Venetian blinds can then be deactivated, if servicing work is being carried out (window cleaning or similar work). After the end of disabling, for instance, at the end of the working hours, automatic operation can only be restarted if it is reactivated in any of the rooms in case of need.

In addition, also the direct operation of an output can be disabled with an independent disabling object. When disabling is active, a direct operation can – independently of the preset priority – never override a sun protection function. In this case, direct operation is non operational in other functions, too. During disabling, incoming direct operation telegrams are completely ignored (positions received via the KNX can then not be tracked either).

If the disabling command is received while a movement initiated by direct operation is in progress, the movement will still be completely finished. Thereafter, direct operation is disabled.

Direct operation disabling example

An office building is equipped with several Venetian blinds to shade individual offices against sunlight. During the working hours, the rooms are to be shaded automatically – e.g. by means of a simple Venetian blind pushbutton sensor on the wall – is to be disabled during the day. For this reason, the direct operation is disabled, for instance, by the porter or by a building services management

Direct operation disabling example

system. Cleaners must have the possibility of controlling the shutters directly only after the normal working hours. In this case, direct operation can again be centrally enabled during evening and night hours.

- i** The disabling functions for automatic and for direct operation can also be combined so that it is possible to intervene at any time and as required by the situation in sun protection control functions.

Sunshine signal in the extended sun protection mode:

In the sun protection mode, the system is informed about the prevailing sunshine condition via the "sunshine" communication object. The system then decides whether shading is required or not. In the extended sun protection mode, the sunshine signal is only evaluated when the automatic operation is activated as well.

A new value received via the "sunshine" object can optionally be evaluated with a time delay. This feature permits suppressing brief brightness variations caused, for instance, by passing clouds or by a thunderstorm. The time delay is started after an update of the "Sunshine" object also in those cases where the automatic operation is deactivated, so that the newly received information about the sunshine conditions may possibly also be processed with a delay, if the automatic operation is activated later on.

Unlike in the simple sun protection mode, an update of the "sunshine" object from active to active or from inactive to inactive in the extended sun protection mode shows generally no reaction. The behaviour of the output is only influenced if a change of state is being detected. An update of the sunshine signal alone does not result in the activation of the automatic operation either.

When the automatic operation is active, the reaction of a specific output at the beginning of shading can be preset separately in the ETS. Amongst other things, this setting permits approaching fixed configured positions or positions preset via the KNX and thus variable. Positions for sun protection purposes can be variably preset, for instance, by means of a weather station for sun position tracking.

In addition, it is possible in case of a defined sun protection positioning movement to have a reference travel executed by forced control. This ensures that identical blind positions are approached synchronously by different outputs in case of a sun protection positioning movement.

The reaction of an output at the end of shading with active automatic operation is also separately parameterizable. In this case, too, it is possible, amongst other things, to approach fixed configured positions.

By means of a priority setting in the ETS parameters it can be specified whether the evaluation of the sunshine signal in the automatic mode can be influenced by a direct operation or whether the automatic mode basically locks the corresponding output during sun protection. The "Manual control", "Forced position" and "Safety" functions invariably have a higher priority so that these functions can override, but not terminate a sun protection including an automatic operation. Thus, the sun protection function is re-executed at the end of a function with a higher priority, if the automatic sunshine protection is still active.

An update (from activated to activated) of the "Automatic" object causes the sun protection to be reactivated, if it had been influenced and cancelled beforehand by a direct operation in accordance with the lower priority.

Automatic mode feedback:

The automatic mode of the extended sun protection has its own 1-bit feedback object for signalling on the KNX whether automatic mode is active or not. This feedback object can be enabled on the parameter page "Relay outputs... -> VBO... - General -> Sun protection" using the parameter "Automatic operation feedback". This parameter also defines whether, on a status change, the object produces active signals automatically or can be read out passively. The telegram polarity is predefined: "OFF" = Automatic mode inactive, "ON" = Automatic mode active.

As a passive status object, no automatic telegram transmission takes place on the bus if the status of the automatic operation changes. Here, the object can only be read out using a read telegram. In the case of an actively-transmitting signal object, the parameter "Time delay for feedback after bus voltage return" can be used to set whether the object value of the feedback is transmitted automatically to the KNX, even after a device reset for initialisation - possibly after a delay.

The schematic diagram of the enlarged sun protection and an example of how sensor components can be integrated into an enlarged sun protection configuration.

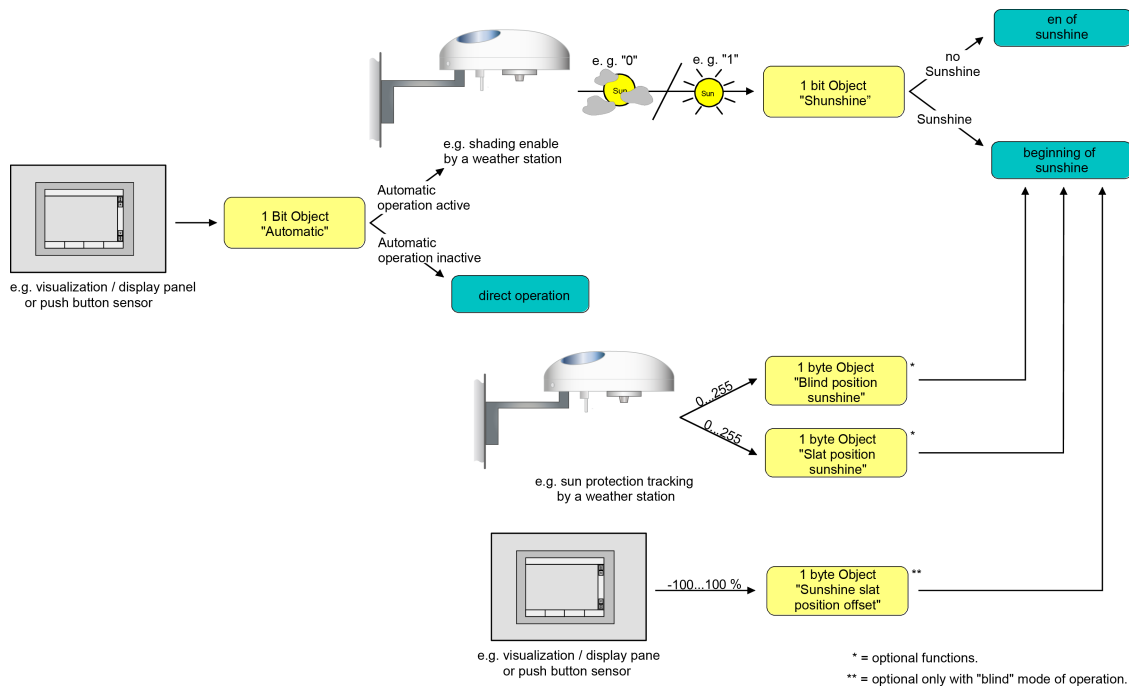

Image 16: Schematic diagram illustrating the extended sun protection configuration (for reasons of simplicity without disabling functions)

The function diagram shows all possible functions of the enlarged sun protection. For reasons of clarity, the functions with a higher priority (manual control, forced position, safety function) are not shown in the diagram.

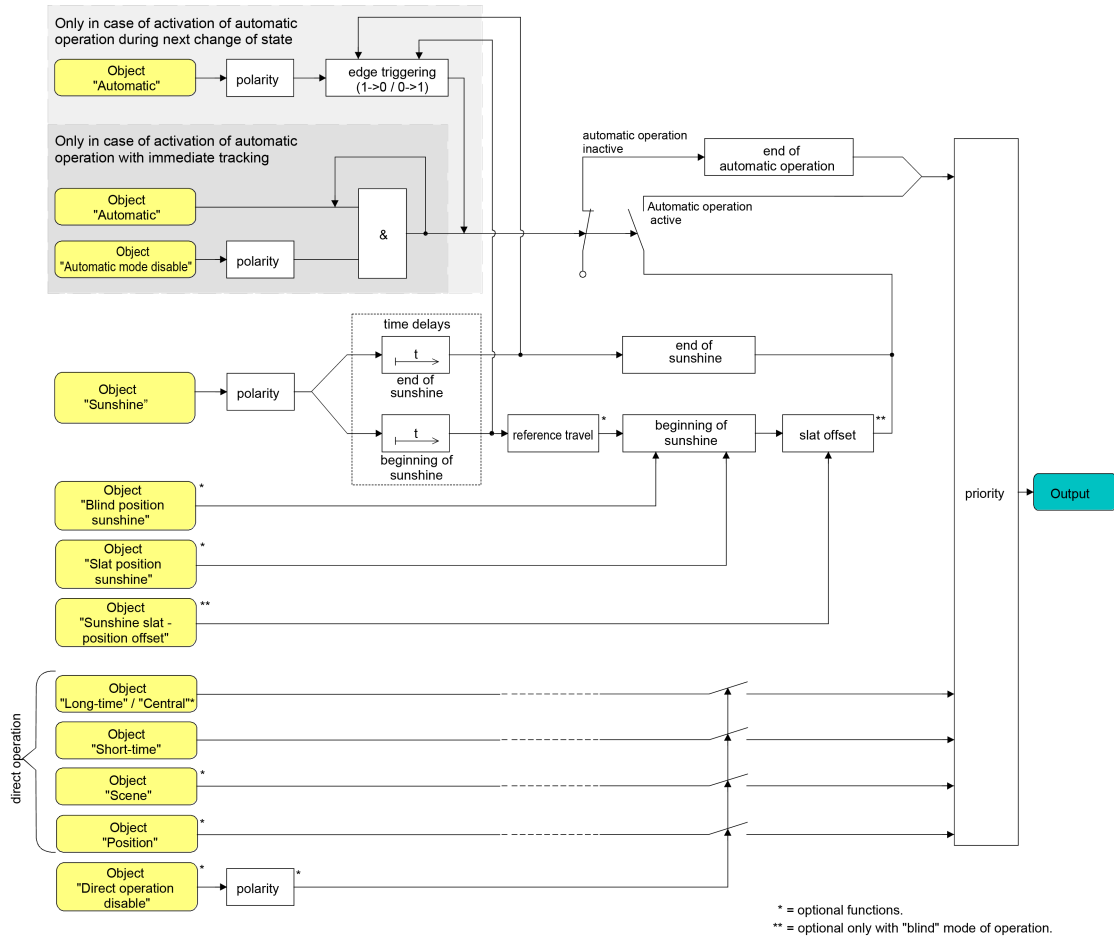

Image 17: Function diagram illustrating the extended sun protection

i The following rules must be observed for the extended sun protection:
After an ETS programming operation, the sun protection function including automatic operation is always deactivated.

Presetting the type of sun protection

The type of sun protection can be preset separately for each venetian blind output. The setting determines whether the simple or the extended type of sun protection is configured.

The sun protection polarity function must be enabled on the parameter page "Relay outputs... -> VBO... -General -> Enabled" in order for the sun protection parameters to be visible

- Set the parameter ""Type of sun protection" to simple sun protection".
Simple sun protection is now configured. The necessary parameters and communication objects are visible.
- Set the parameter "Type of sun protection" to "extended sun protection".
Extended sun protection is now configured. The necessary parameters and communication objects are visible.

Presetting the priority of sun protection (for simple sun protection only)

The priority of the sun protection function can be set separately for each venetian blind output. In the simple sun protection, the priority between the "Sunshine" object and the objects of direct operation (short-time, long-time, central or position telegram, scene recall) must be configured.

The sun protection function must be enabled on the parameter page "Relay outputs... -> VBO... -General -> Enabled" in order for the sun protection parameters to be visible.

The function must have been configured for simple sun protection.

- Set the parameter

"Priority of sun protection operation with respect to direct operation" on the parameter page "Relay outputs... -> VBO... General -> Sun protection" to "Same priority".

The sun protection mode can be overridden at any time by direct operation. Similarly, the sun protection overrides the direct operation, when a new "sunshine" telegram is received via the object of the same name and when a configured time delay, if any, has elapsed. If the sun protection function is overridden by a direct operation, the preset behaviour "at the end of sunshine" will not be executed.

- Set the parameter

"Priority of sun protection operation with respect to direct operation" to "Higher priority".

An active sun protection will override a direct operation. The sun protection mode can therefore not be interrupted by a direct operation. Direct operation will be possible again only after the sun protection function is terminated.

- Set the parameter

"Priority of sun protection operation with respect to direct operation" to "Lower priority".

A direct operation can at any time override the sun protection mode. If the sun protection function is overridden by a direct operation the preset behaviour "at the end of sunshine" will not be executed. The sun protection function can only be reactivated after an enabling movement controlled by a direct operation has been effected and after a new "sunshine" telegram has been received via the "sunshine" object. Attempts to activate the sun protection function are ignored for as long as the enabling movement has not taken place.

On the enabling movement:

An enabling movement is an accomplished long-time movement into the upper end position which has been initiated by the objects "Long time operation" or "Central travel control". A manual operation, an upward movement after bus voltage return, a position approach to "0 %" or an upward movement after enabling of forced position or safety functions have no enabling effect.

The sun protection is not enabled if the enabling movement has been interrupted. The sunshine protection function will be also be disabled if the output has

been readjusted again by a direct operation after an accomplished enabling movement.

After an ETS programming operation or switch-on of the supply voltage, the sunshine protection function is always enabled.

- i** Manual local operation on the device itself, the forced position function and the safety functions have a fixed priority higher than that of the sun protection. The sun protection is overridden – but not terminated – by a function with a higher priority. After the end of the function with the higher priority the reaction at the beginning of sun protection will therefore be executed again, if the sun protection is still active at this time.
- i** With the settings "same priority" or "lower priority", the sun protection can be overridden by a direct operation only if the direct control action can be executed at once. A direct operation will therefore not override the sun protection during a manual control locally on the device, an active forced position function or an active safety function.
- i** Parameter setting "same priority" or "lower priority": A variable preset of blind/shutter and slat positions or of a slat offset via the KNX at the beginning of sunshine shows no reaction at the output, if the sun protection was overridden by direct operation. However, the position data or offsets received are stored internally so that the new positions will be approached on reactivation of the sun protection.

Presetting the priority of automatic sun protection (for extended sun protection only)

The priority of the automatic sun protection function can be set separately for each output. In the extended sun protection, the priority between the "Sunshine" object and the objects of direct operation (short-time, long-time, central or position telegram, scene recall) must be configured. The selected priority affects the evaluation of the sunshine signal in the automatic mode and not the automatic mode itself.

The sun protection function must be enabled on the parameter page "Relay outputs... -> VBO... -General -> Enabled" in order for the sun protection parameters to be visible.

The function must have been configured for extended sun protection.

- Set the parameter "Priority of sun protection operation with respect to direct operation" on the parameter page "Relay outputs... -> VBO... General -> Sun protection" to "Same priority".

The sunshine signal of the automatic sun protection mode and the corresponding reaction can be overridden at any time by direct operation. Similarly, the sunshine signal overrides the direct operation, when a new "sunshine" or "no sunshine" telegram is received via the "Sunshine" object and when this telegram results in a change of state. Moreover, a configured delay time, if any, must have elapsed. If the direct operation overrides the sunshine signal, the preset behaviour "at the end of sunshine" will not be executed.

- Set the parameter "Priority of sun protection operation with respect to direct operation" to "Higher priority".

An active automatic mode always overrides the direct operation independent of the sunshine signal. The sunshine signal can therefore not be interrupted by a direct operation. Direct operation will be possible again only after the automatic mode is terminated.

- Set the parameter "Priority of sun protection operation with respect to direct operation" to "Lower priority".

A direct operation can at any time override the sunshine signal. If the sunshine signal function is overridden the preset behaviour "at the end of sunshine" will not be executed. The sunshine signal will be evaluated again only after an enabling movement controlled by a direct operation has been effected and when a new "sunshine" or "no sunshine" telegram is received via the "Sunshine" object and when this telegram results in a change of state. The sun protection function is ignored for as long as the enabling movement has not taken place.

On the enabling movement:

An enabling movement is an accomplished long-time movement into the upper end position which has been initiated by the objects "Long time operation" or "Central travel control". A manual operation, an upward movement after bus voltage return, a position approach to "0 %" or an upward movement after enabling of forced position or safety functions have no enabling effect.

The sunshine signal is not enabled if the enabling movement has been interrupted. The sunshine signal will be also be disabled, if the output has been re-adjusted again by a direct operation after an accomplished enabling movement.

- i** A direct operation never terminates the automatic mode. Irrespective of a function being overridden by a direct operation, an activation of the automatic mode (telegram update of the "automatic sun protection" object) always re-enables the sunshine signal as well and evaluates it when the automatic mode is active. Attention must be paid to this behaviour especially in those cases where the "automatic sun protection" object" is cyclically overwritten by telegrams.
- i** Manual local operation on the device, the forced position function and the safety functions have a fixed priority higher than that of the automatic sun protection. The sun protection is overridden – but not terminated – by a function with a higher priority. After the end of the function with the higher priority the reaction last executed by the automatic sun protection will therefore be executed again, if the sun protection is still active at this time.

- i** With the settings "same priority" or "lower priority", the sunshine signal can be overridden by a direct operation only if the direct control action can be executed at once. A direct operation will therefore not override the sunshine signal during a manual control locally on the device, an active forced position function or an active safety function.
- i** Parameter setting "same priority" or "lower priority": A variable preset of blind/shutter and slat positions or of a slat offset via the KNX at the beginning of sunshine shows no reaction at the output, if the sunshine signal was overridden by direct operation. However, the position data or offsets received are stored internally so that the new positions can be approached when the sensor signals that the sun is shining again.
- i** Irrespective of the preset priority, an update of the "Sunshine" object from active to active or from inactive to inactive in the extended sun protection mode shows generally no reaction. The behaviour of the output is only influenced if a change of state is being detected.

Presetting the polarity of the "Sunshine" object

The telegram polarity of the "Sunshine" object can be preset separately for each output. This means that an adaptation to the signals from existing sensors or weather stations is possible in the simple and also in the extended sun protection mode.

The sun protection function must be enabled on the parameter page "Relay outputs... -> VBO... -General -> Enabled" in order for the sun protection parameters to be visible.

- Set the parameter "Polarity of 'Automatic' object" on the parameter page ""Relay outputs... -> VBO... General -> Sun protection" to the required telegram polarity.

The sunshine signal is evaluated in accordance with the preset priority.

- i** In the simple sun protection an update (from activated to activated) of the "Sunshine" object causes the sun protection to be reactivated if it had been influenced and possibly re-enabled beforehand by a direct operation in acc. with the preset priority.
- i** In the extended sun protection mode, an update of the "Sunshine" object from active to active or from inactive to inactive shows generally no reaction. The behaviour of the output is only influenced if a change of state is being detected.

Setting the activation of the automatic mode (for extended sun protection only)

As far as the activation of the automatic mode is concerned, two cases must be distinguished which can be configured with the help of ETS parameters separately for each output. Either a travel movement in acc. with the reaction at the beginning or the end of sunshine is executed immediately on activation of the automatic mode, or

otherwise the system waits after activation of the automatic mode for a new change of state in the "Sunshine" object" until the corresponding output shows the reaction at the beginning or at the end of sunshine.

The sun protection function must be enabled on the parameter page "Relay outputs... -> VBO... General -> Enabled" in order for the sun protection parameters to be visible.

The function must have been configured for extended sun protection.

- Set the parameter "Activation via" on the parameter page "Relay outputs... -> VBO... General ->Sun protection" to "object 'Automatic' & next change of state".

Automatic operation is activated as soon as the "Automatic sun protection" object is set to active in accordance with polarity. A reaction at the output occurs, however, only after a new change of state has been signaled via the "sunshine" object. In this case, the new state (beginning of sunshine or end of sunshine) determines the behaviour of the output.

- Set the parameter "Activation by" to "Object 'Automatic' & immediate tracking".

Automatic operation is activated as soon as the "Automatic sun protection" object is set to active in accordance with polarity. The state of the "sunshine" object determines the behaviour of the output immediately (beginning of sunshine or end of sunshine).

Presetting the polarity of the "Automatic" object (for extended sun protection only)

The telegram polarity of the automatic object can be set.

The sun protection function must be enabled on the parameter page "Relay outputs... -> VBO... -General -> Enabled" in order for the sun protection parameters to be visible.

The extended sun protection must be configured for activation of the automatic mode on next change of state.

- Set the parameter "Polarity of 'Automatic' object" on the parameter page "Relay outputs... -> VBO... General -> Sun protection" to the required telegram polarity.

The telegram to the "Automatic sun protection" object will be evaluated depending on the selected priority.

- i** After an ETS programming operation or after switch-on of the supply voltage, the "automatic sun protection" object must at first have data written into it by the KNX also in case of inverted polarity before the automatic mode can be activated.

Presetting the disabling function for the automatic mode (for extended sun protection only)

The automatic mode can be deactivated via a separate disabling object. After enabling of the disabling function in the ETS parameters, the "Sun protection - automatic mode disable" object becomes visible.

The sun protection function must be enabled on the parameter page "Relay outputs... -> VBO... -General -> Enabled" in order for the sun protection parameters to be visible.

The extended sun protection must be configured for activation of the automatic mode with immediate tracking of the sunshine signal.

- Activate the parameter "Disabling function" on the parameter page "Relay outputs... -> VBO... General -> Sun protection".

The disabling function is enabled. The parameter for setting of the polarity becomes visible.

- Set the parameter "Polarity of object 'Automatic mode disable'" to the required telegram polarity.

The telegram to the "Automatic sun protection disable" object will be evaluated depending on the selected priority.

i The "automatic sun protection" and "sun protection - automatic disable" objects are logically combined (AND with feedback). When disabling is activated, the automatic operation is reset and thus aborted. The output concerned will then show the behaviour at the end of automatic operation. The automatic mode can only be reactivated, if the disabling object is enabled and if the "automatic sun protection" object is updated again by writing an "ON" telegram into it. Any attempt to activate the automatic mode while a disable is active will be ignored.

i After an ETS programming operation or after switch-on of the supply voltage, the "automatic sun protection" and "sun protection - automatic mode disable" objects are always initialised with "OFF". If the disabling object works with inverted polarity (setting "disabled" = "0") the disabling function is in this case immediately active.

Presetting the disabling function for direct operation (for extended sun protection only)

The direct mode can be deactivated at any time via a separate disabling object. After enabling of the disabling function in the ETS parameters, the "Direct operation disable" object becomes visible.

The sun protection function must be enabled on the parameter page "Relay outputs... -> VBO... -General -> Enabled" in order for the sun protection parameters to be visible.

The function must have been configured for extended sun protection.

- Activate the parameter "Disabling function for direct operation" on the parameter page "Relay outputs... -> VBO... General -> Sun protection".
The disabling function is enabled. The parameter for setting of the polarity becomes visible.
 - Set the parameter "Polarity of object 'Disable direct operation'" to the required telegram polarity.
The telegram to the "sun protection disable" - direction operation disable" object will be evaluated depending on the selected priority.
- i** After an ETS programming operation or after switch-on of the supply voltage, the "sun protection - automatic mode disable" object is always initialised with "OFF". If the disabling object works with inverted polarity (setting "disabled" = "0") the disabling function is in this case immediately active.

Presetting the reaction at the end of automatic operation (for extended sun protection only)

When the automatic operation is being deactivated – also by the disabling function – the output concerned will show the preset reaction, if no function with a higher priority is active at the time of deactivation. The preset reaction will not be executed either on termination of the automatic operation, if the sunshine signal is overridden on account of priority settings by a direct operation. The reaction at the end of automatic operation is preset on the parameter page "Relay outputs... -> VBO... General -> Sun protection -> Sun protection end".

The sun protection function must be enabled on the parameter page "Relay outputs... -> VBO... -General -> Enabled" in order for the sun protection parameters to be visible.

The function must have been configured for extended sun protection.

- Set the parameter "at the end" to "no reaction".
At the end of automatic operation the relay of the output shows no reaction. Any travel movements still in progress at this instant will still be finished.
- Set the parameter "at the end" to "raising" or "opening".
At the end of automatic operation, the actuator raises the blind/shutter or opens the venting louver/roof window.
- Set the parameter "at the end" to "lowering" or "closing".
At the end of automatic operation, the actuator lowers the blind/shutter or closes the venting louver/roof window.
- Set the parameter "at the end" to "stop".
At the end of automatic operation, the actuator switches the relays of the output to the "stop" position. A travel movement, if any, will be interrupted.

- Set the parameter "at the end" to "tracking the position".
 At the end of automatic operation, the output will be set to the state last adjusted statically before the automatic sun protection or to the state tracked and internally stored during the automatic sun protection. The position objects, the long-time object and the scene function are tracked.
- ⓘ The behaviour preset in this parameter will only be executed, if no function with a higher priority (e.g. safety) is activated at the end of automatic operation.
- ⓘ Parameter setting "Position tracking": The actuator can track absolute positions (position telegram, scene value) at the end of automatic operation only if the position data are known and if the positions have been predefined. There is otherwise no reaction at the end of automatic operation.
 Position data can be tracked, if the output was in a defined position before the automatic sun protection function or if a new position telegram was received via the position objects during the sun protection. In the latter case, a reference movement will be executed at the end of automatic operation, if the position before or during the sun protection was unknown.
 Known slat positions will also be tracked as described. This is also the case, when the height of the Venetian blind is unknown.
 Long time travel movements (movements without position preset) will always be tracked.

Setting automatic operation feedback (for extended sun protection only)

The automatic mode of the extended sun protection has its own 1-bit feedback object for signalling on the KNX whether automatic mode is active or not. This feedback object can be enabled on the parameter page "Relay outputs... -> VBO... - Sun protection" using the parameter "feedback". This parameter also defines whether, on a status change, the object produces active signals automatically or can be read out passively. The telegram polarity is fixed: "0" = Automatic mode inactive, "1" = Automatic mode active.

The sun protection function must be enabled on the parameter page "Relay outputs... -> VBO... -General -> Enabled" in order for the sun protection parameters to be visible.

The function must have been configured for extended sun protection.

- Set the parameter "Feedback" on the parameter page "Relay outputs... -> VBO... General -> Sun protection " to "Feedback object is active signalling object".
 The feedback object is enabled. The status information is transmitted as soon there is a change in automatic operation.
- Set the parameter to "feedback object is passive status object".
 The feedback object is enabled. The status information will be transmitted in response only if the feedback object is read out from by the KNX.

The feedback must be set as actively transmitting.

- If a delay after bus voltage return should be necessary, activate the parameter "Time delay for feedback after bus voltage return" on the parameter page "Relay outputs... -> VBO... - sun protection".

The status information will be transmitted with a delay after bus voltage return. No feedback telegram is transmitted during a running delay, even if the status information changes during this delay.

Presetting a time delay for beginning and end of sunshine

The telegram received via the "sunshine" object for activation or deactivation of shading (depending on polarity) can be evaluated with a time delay separately for each output. The preset delay times are always evaluated in the simple as well as in the extended sun protection mode.

The sun protection function must be enabled on the parameter page "Relay outputs... -> VBO... -General -> Enabled" in order for the sun protection parameters to be visible.

- Set the parameter "Delay at the beginning of sunlight" on the parameter page "Relay outputs... -> VBO... General -> Sunshine -> Set Sun protection start" to the required delay time.

The telegram for activation of the sun shading will be evaluated with a delay corresponding to the setting.

- Set the parameter "Delay at the end of sunlight" on the parameter page "Relay outputs... -> VBO... General -> Sunshine -> Set Sun protection end" to the required delay time.

The telegram for deactivation of the sun protection will be evaluated with a delay corresponding to the setting.

i A setting of "0" in the parameters deactivates the respective delay time. In this case, the state of the sunshine signal is evaluated immediately.

i Simple sun protection mode: An update (from activated to activated) of the "Sunshine" object causes the sun protection to be reactivated in consideration of the delay time, if the sun protection had been influenced or aborted beforehand by a direct operation because of the same or a lower priority.

i Extended sun protection: The time delay is started after an update of the "Sunshine" object also in those cases where the automatic operation is deactivated so that the newly received information about the sunshine conditions may possibly also be processed with a delay, if the automatic operation is activated later on. Unlike in the simple sun protection mode, an update of the "sunshine" object from active to active or from inactive to inactive in the extended sun protection mode shows generally no reaction. The behaviour of the output is only influenced if a change of state is being detected. An update of the sunshine signal alone does not result in the activation of the automatic operation either.

Presetting the reaction at the beginning of sunshine

The behaviour of the output at the beginning of sunshine / shading – if applicable, after the end of the delay time – can be configured in the ETS separately for each output. In the simple sun protection mode, the behaviour will be executed, when the sun protection function is activated after receiving a new sunshine signal. In the extended sun protection mode, the output shows the configured reaction, when automatic operation is activated and when a new sunshine signal ("sun is shining") is being received or was received beforehand. The reaction will not be executed if a function with a higher priority is active at the time the sun shading is received. The reaction for the beginning of sunlight is set on the parameter page "Relay outputs... -> VBO... General -> Sunshine -> Sun protection start".

The sun protection function must be enabled on the parameter page "Relay outputs... -> VBO... -General -> Enabled" in order for the sun protection parameters to be visible.

- Set the parameter "at the beginning of sunshine" to "no reaction".
At the beginning of shading, the output switches over to sun protection while the relays of the output show no reaction. Any travel movements still in progress at this instant will still be finished.
 - Set the parameter "at the beginning of sunshine" to "raising" or "opening".
At the beginning of shading, the actuator raises the blind/shutter or opens the venting louver/roof window.
 - Set the parameter "at the beginning of sunshine" to "lowering" or "closing".
At the beginning of shading, the actuator lowers the blind/shutter or closes the venting louver/roof window.
 - Set the parameter "at the beginning of sunshine" to "stop".
At the beginning of shading, the actuator switches the relays of the output to the "stop" position. A travel movement, if any, will be interrupted.
 - Set the parameter "at the beginning of sunshine" to "internal scene recall".
Configure the internal scene to be recalled (parameter "internal scene").
At the beginning of shading, the actuator recalls the position value for the output concerned which was preset in the scene configuration. This is not a scene recall as in direct operation, but only an approach to the corresponding scene position value.
 - Set the parameter "at the beginning of sunshine" to "fixed position".
At the beginning of shading, the actuator recalls a fixed position value for the output concerned.
- i** In the "Venetian blind" operating mode, the "fixed position" setting can be selected separately for the height of the blind and for the slat position. For this reason, the ETS adapts the parameter selection and enlarges the setting options in this operating mode.

- "Fixed position" only: Set the parameter "Fixed position of Venetian blind", "Fixed position of roller shutter/awning" or "Fixed position of venting louver" to "as specified by parameter". Thereafter, set the parameter "Position of Venetian blind (0...100%)", "Position of roller shutter/awning (0...100%)" or "Position of venting louver (0...100%)" to the desired position.

At the beginning of shading, the output invariably approaches the configured position value.
 - "Fixed position" only: Set the parameter "Fixed position of Venetian blind", "Fixed position of roller shutter/awning" or "Fixed position of venting louver" to "no change of current position".

At the beginning of shading, the last set position of the Venetian blind height, shutter, awning or venting louver will be maintained.
 - "Fixed position" and operating mode = "Venetian blind" only: Set the parameter "Fixed slat position (0...100%)" to the desired position value.

At the beginning of shading, the output invariably moves the slats to the configured position after the height of the Venetian blind has been adjusted.
 - Set the parameter "at the beginning of sunshine" to "variable position".

At the beginning of shading, the actuator recalls the variably specified position value for the output concerned. The variable position of the Venetian blind height, of the shutter, awning or venting louver position is preset via the separate communication object "sun protection - ...position" (in the "Venetian blind" operating mode for the slats as well as via the separate object "sun protection - slat position").
- i** In the "Venetian blind" operating mode, the "variable position" setting can be selected separately for the Venetian blind height and for the slat position. For this reason, the ETS adapts the parameter selection and enlarges the setting options in this operating mode.
- i** The behaviour preset in this parameter will only be executed, if no function with a higher priority (e.g. safety) is activated at the time of shading.
- i** "Internal scene recall" setting: For this setting, the scene function of the output must be enabled in the ETS. Otherwise, the positions approached at the beginning of sun shading are undefined positions. The scene position values stored in the actuator by a scene storage function will be approached as well. A delay configured for scene recalls has no influence on the recall of the scene value by the sun protection function.
- i** "Variable position" setting: After an ETS programming operation or after switch-on of the supply voltage the objects "sun protection - ...position" and "sun protection - slat position" must receive position values from the KNX. Otherwise the actuator does not position itself at the start of sun shading as it does not have any valid position data.
- When the actuator is in operation, the position data can be updated at any

time via the KNX even if the sun protection is active (e.g. by a weather station for the purpose of sun position tracking). The actuator will then immediately approach the newly received positions if sun shading is active. If a function with a higher priority is active, the actuator stores the newly received position values and approaches them during a later shading operation. The position data last received are not lost in a bus voltage failure.

Presetting a forced reference movement in the sun protection mode

If needed, a reference movement can be executed by forced-control in the simple and in the extended sun protection mode at the beginning of a shading cycle, if fixed or variable position values or scene positions are to be approached or a scene is recalled. The execution of a reference movement by forced control at the beginning of shading can be used in a sun protection positioning operation to ensure that the curtains or slats are moved synchronously by different outputs to identical positions (e.g. in a long row of windows). Without the execution of reference travel by forced control, there might otherwise be positioning inaccuracies with a negative effect on the overall appearance of a building facade with the blinds let down.

A reference movement by forced control will always be executed in the simple sun protection mode, when the beginning of shading is signaled via the "sunshine" object. Updates of the object from "Sun is shining" to "Sun is shining" do not initiate a reference movement if, at this time, the output is still in the sun protection position.

A reference movement by forced control will be executed in the extended sun protection mode, when the beginning of shading is signaled via the "Sun shading facade" object "sunshine" object. Updates of the object from "Sun is shining" to "Sun is shining" will never initiate a reference movement. In this case, the sunshine signal must first change from 'sun is not shining' to 'sun is shining' before a new reference movement can take place.

A reference movement by forced control will always be executed for synchronisation purposes as described and also in such cases where the position data of the blind or the slats are known. No reference movement by forced control will be executed at the end of shading.

The sun protection function must be enabled on the parameter page "Relay outputs... -> VBO... -General -> Enabled" in order for the sun protection parameters to be visible.

- Activate the parameter
"reference movement before every sun protection positioning operation" on the parameter page
"Relay outputs... -> VBO... General -> Sunshine -> Sun protection start".

At the beginning of shading there is always a reference movement by forced control as described. The preset position will be approached after the end of the reference movement.

- Deactivate the parameter
"reference movement before every sun protection positioning operation".

A reference movement at the beginning of sun protection will only be executed, if the position data are unknown, for instance, after an ETS programming operation or after switch-on of the power supply. In all other cases, the preset shading position will be approached immediately.

- i** A reference movement is the time required for a travel movement into the upper end position increased by 20 % and additionally by the configured travel time extension. A reference travel is not retriggerable.
- i** Variable position preset: No reference movement will be executed, if new position values are preset via the KNX while the sun protection is active.
- i** "Venetian blind" operating mode: A terminated reference travel for the height of the blind also synchronizes the slat position at the same time.

Slat offset in the sun protection mode (only "Venetian blind" operating mode)

An offset can be specified for the slat position at the start of sun shading separated for each venetian blind output, if fixed or variable slat position values are to be approached. If necessary, the slat offset can correct the fixed or variable nominal slat position and thus allow the creation of an individual shading situation, when the sun protection is active. The offset can be preset in two ways...

- The slat offset can be configured statically in the ETS. The configuration of a static offset value allows to vary the degree of shading in those parts of the building that are not exposed to full sunshine due to objects in front of the building. The variable slat angle adjusted by the sun protection control or the fixed angle specified in a parameter can thus be overridden so that the slats are always opened a bit wider than originally preset. Alternatively, the slats can also be closed completely by means of the static offset if too much sunlight is reflected into the room.
- The slat offset can additionally be adapted by the KNX via the separate communication object "sunshine protection - slat position offset". In this way, the desired slat offset can also be adjusted during an active shading cycle and independent of a direct operation as, for instance, the short time mode. Thus, it is possible, for instance, that persons in a room can correct the slat angle at any time 'manually' and individually by selecting another preset value at a touch sensor or a visualisation. An offset preset via the object overwrites the value configured in the ETS.

The preset offset is taken into account in the simple and in the extended sun protection mode for each positioning move during an active shading cycle (beginning of sunshine) and added to the predefined nominal slat position. The offset value can be varied within a range from -100 % ... 0 ... 100 % so that the slats can be moved in both directions into the slat end positions. At an offset of "0 %", the actual slat position is always identical with the predefined nominal slat position for sun protection purposes.

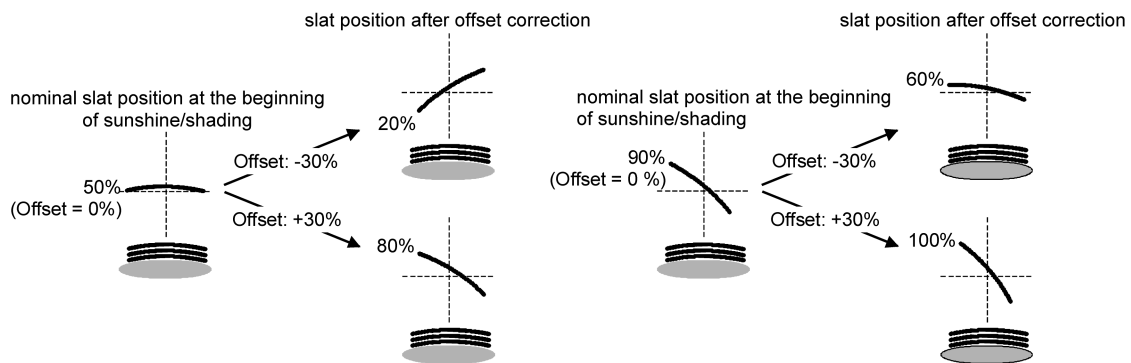

Image 18: Functional principle of slat offset
(example showing slat type 1 / slat type 2 identical)

The position value actually adjusted with the offset after adding the slat position value is always between 0 and 100 %. Minimum and maximum position are thus determined by the slat end positions. These limits cannot be exceeded by specifying an greater offset. Example...

Slat position at the beginning of sunshine = 90 %

Sunshine offset slat position = +30 %

-> The resulting slat position is 100% as the end position is reached.

In acc. with the KNX data point type 6.001 (DPT_Percent_V8) the data format of the communication object "sun protection slat position offset" permits presetting positive and negative values in a range of -128 ... 0 ... +127. The actuator interprets the value received directly as an offset in %. Values below 100 or above +100 are limited to the minimum (-100 %) and maximum offset (+100 %) and evaluated accordingly.

An offset preset via the object overwrites the value configured in the ETS. In the event of a bus voltage failure, an offset value received via the communication object can be stored internally in a non-volatile memory so that the offset value last received is not lost even in case the power supply fails. As an alternative, the offset preset via the KNX can be reset (0 %) in the event of a power supply failure with the result that the value configured in the ETS is again used in operation. The offset reaction preset in the event of bus voltage failure can be configured in the ETS.

Configuring the slat offset in the sun protection mode (only "Venetian blind" operating mode)

The sun protection function must be enabled on the parameter page "Relay outputs... -> VBO... -General -> Enabled" in order for the sun protection parameters to be visible.

The function must be configured for the "Venetian blind" operating mode.

The reaction at the beginning of sunshine must be configured to a fixed or variable position preset.

- Set the parameter "Offset the slat position during sunshine" on the parameter page "Relay outputs... -> VBO... General -> Sun protection -> Beginning of sun protection" to "no offset".

Offset correction is deactivated. During shading (beginning of sunshine), the fixed or variable slat position will be approached without offset correction. The other parameters relating to offset configuration are hidden.

- Set the parameter "offset of the slat position during sunshine" to "offset as parameter".

The static offset correction based on the parameter specification in the ETS is activated. During every shading operation (beginning of sunshine), the nominal slat position is always corrected by the configured offset value.

- Set the parameter "offset of the slat position during sunshine" to "offset as parameter and via object".

The offset correction based on the parameter specification in the ETS and specification via the object is activated. The slat offset is preset by a fixed value configured in the ETS and can be adapted dynamically with a separate communication object. During every shading operation (beginning of sunshine), the nominal slat position is always corrected by the preset offset value.

- Set the parameter "Slat offset position (-100 ... 100 %)" to the desired offset value.

The configured value defines the static offset correction of the slat position. The configured value can be re-adjusted via the "sun protection - offset slat position object" if the communication object has been enabled.

- Deactivate the parameter "store in case of bus voltage failure".

The value received via the object will only be stored temporarily in volatile memory. The received value only replaces the configured value until the actuator is reinitialised. After the initialisation, the offset value configured in the ETS will be used again.

- Activate the parameter "store in case of bus voltage failure".

The value received via the object will be stored in case of bus voltage failure in a non-volatile memory of the actuator. The originally configured offset value is definitely overwritten in the process. Only a new ETS programming operation sets the offset back to the configured value.

i An offset value received via the KNX is stored temporarily or permanently in the actuator and taken into account during the next shading operation. The reception of an offset value during an active shading phase (beginning of sunshine active) results in immediate and visible correction of the offset angle by the output.

i After an ETS programming operation, the offset is always set to the value configured in the ETS.

i The slat offset has no influence on the behaviour of an output at the end of a shading phase (end of sunshine).

Presetting the reaction at the end of sunshine (for simple sun protection only)

At the end of the shading phase – if applicable, after the end of the delay time – the output concerned will show the preset reaction, if no function with a higher priority is active at the time of deactivation. The preset reaction will also not be executed at the end of sun shading, if the sunshine signal is overridden on account of priority settings by a direct operation.

The reaction for the beginning of sunlight is set on the parameter page "Relay outputs... -> VBO... General -> Sun protection -> Sun protection end".

The sun protection function must be enabled on the parameter page "Relay outputs... -> VBO... -General -> Enabled" in order for the sun protection parameters to be visible.

The function must have been configured for simple sun protection.

- Set the parameter "at the end of sunshine" to "no reaction".
At the end of shading, the relay of the output shows no reaction. Any travel movements still in progress at this instant will still be finished.
 - Set the parameter "at the end of sunshine" to "raising" or "opening".
The actuator raises the blind/shutter or opens the venting louver/roof window at the end of shading.
 - Set the parameter "at the end of sunshine" to "lowering" or "closing".
The actuator lowers the blind/shutter or closes the venting louver/roof window at the end of shading.
 - Set the parameter "at the end of sunshine" to "stop".
At the end of shading, the actuator switches the relays of the output to the "stop" position. A travel movement, if any, will be interrupted.
 - Set the parameter "at the end of sunshine" to "tracking the position".
At the end of shading, the output will be set to the state last adjusted statically before sun protection or to the state tracked and internally stored during sun protection. The position objects, the long-time object and the scene function are tracked.
- i** The behaviour preset in this parameter will only be executed, if no function with a higher priority (e.g. safety) is activated when the sun protection is enabled or when a direct operation has not overridden the sunshine signal on account of priority settings.
- i** Parameter setting "Position tracking": The actuator can track absolute positions (position telegram, scene value) at the end of sun protection only if the position data are known and if the positions have been predefined. There is otherwise no reaction at the end of sun shading.
Position data can be tracked, if the output was in a defined position before the sun protection function or if a new position telegram was received via the position objects during the sun protection. In the latter case, a reference move-

ment will be executed at the end of sun protection, if the position before or during the sun protection was unknown.

Known slat positions will also be tracked as described. This is also the case, when the height of the Venetian blind is unknown.

Long time travel movements (movements without position preset) will always be tracked.

Presetting the reaction at the end of sunshine (for extended sun protection only)

The behaviour of the output at the end of sunshine / shading – if applicable, after the end of the delay time – can be configured in the ETS separately for each output. In the extended sun protection mode, the output shows the configured reaction, when automatic operation is activated and when a new sunshine signal (change of state from "sun is shining" -> "sun is not shining") is being received. The reaction will not be executed if a function with a higher priority is active at the time the sunshine signal changes. The preset reaction will not be executed either, if the sunshine signal is overridden on account of priority settings by a direct operation. The reaction for the beginning of sunlight is set on the parameter page "Relay outputs... -> VBO... General -> Sun protection -> Sun protection end".

The sun protection function must be enabled on the parameter page "Relay outputs... -> VBO... -General -> Enabled" in order for the sun protection parameters to be visible.

The function must have been configured for extended sun protection.

- Set the parameter "at the end of sunshine" to "no reaction".
At the end of shading, the relay of the output shows no reaction. Any travel movements still in progress at this instant will still be finished.
- Set the parameter "at the end of sunshine" to "raising" or "opening".
The actuator raises the blind/shutter or opens the venting louver/roof window at the end of shading.
- Set the parameter "at the end of sunshine" to "lowering" or "closing".
The actuator lowers the blind/shutter or closes the venting louver/roof window at the end of shading.
- Set the parameter "at the end of sunshine" to "stop".
At the end of shading, the actuator switches the relays of the output to the "stop" position. A travel movement, if any, will be interrupted.
- Set the parameter "at the end of sunshine" to "internal scene recall". Configure the internal scene to be recalled (parameter "internal scene").
At the beginning of shading, the actuator recalls the position value for the output concerned which was preset in the scene configuration. This is not a scene recall as in direct operation, but only an approach to the corresponding scene position value.
- Set the parameter "at the end of sunshine" to "tracking the position".

At the end of shading, the actuator recalls a fixed position value for the affected output.

i In the "Venetian blind" operating mode, the "fixed position" setting can only be selected in common for the height of the blind and for the slat position.

- "Fixed position" only: Set the parameter "Fixed position of Venetian blind", "Fixed position of roller shutter/awning" or "Fixed position of venting louver" to "as specified by parameter". Thereafter, set the parameter "Position of Venetian blind (0...100%)", "Position of roller shutter/awning (0...100%)" or "Position of venting louver (0...100%)" to the desired position.

At the end of shading, the output invariably approaches the configured position value.

- "Fixed position" only: Set the parameter "Fixed position of Venetian blind", "Fixed position of roller shutter/awning" or "Fixed position of venting louver" to "no change of current position".

At the end of shading, the last set position of the Venetian blind height, the shutter, awning or venting louver will be maintained.

- "Fixed position" and operating mode = "Venetian blind" only: Set the parameter "Fixed slat position (0...100%)" to the desired position value.

At the end of shading, the output invariably moves the slats to the configured position after the height of the Venetian blind has been adjusted.

i The behaviour preset in this parameter will only be executed, if no function with a higher priority (e.g. safety) is activated at the time the sunshine signal changes. The preset reaction will not be executed either, if the sunshine signal is overridden on account of priority settings by a direct operation.

i "Internal scene recall" setting: For this setting, the scene function of the output must be enabled in the ETS. Otherwise, the positions approached at the end of sunshine/shading are undefined positions. The scene position values stored in the actuator by a scene storage function will be approached as well. A delay configured for scene recalls has no influence on the recall of the scene value by the sun protection function.

10.8.1 Automatic heating/cooling

Automatic heating/cooling can supplement the extended sun protection so that the sun shading of a room is available to an additional application. When automatic heating / cooling is active, a presence signal – e.g. from a KNX/EIB presence detector or monitor – is evaluated in addition to the signals of the extended sun protection function. The automatic sun protection function will then only be activated by the actuator when people are in the room. The room is then shaded or not shaded according to the sunshine signal - as described in previous chapters.

If no presence is signalled to the actuator, it additionally evaluates a heating/cooling signal derived, for instance, from a room temperature controller or from an outside thermostat. In this case, the shading function can be used to support the heating or cooling function in a room. As no persons are present in the room, intensive sunlight can be used, for instance, to heat up the room by opening the slats or by raising the curtain. Similarly, the room can also be shaded against sunlight during the absence of persons, if additional heating up of the room is not desired.

The evaluation of the three 1-bit signals "Presence", "Heating/cooling switchover" and "sunshine", whose telegram polarity can be set independently in the ETS, means that the extended sun protection function with automatic heating/cooling differentiates between the 6 statuses shown in the following table and the corresponding output reactions.

Presence	Heating/cooling switchover	Sunshine / shading facade	Reaction at output
People present	--- (irrelevant)	Sunshine active	At the beginning of sunshine
People present	--- (irrelevant)	Sunshine inactive	At the end of sunshine
No people present	Heating active	Sunshine active	At the beginning of sunshine with heating
No people present	Heating active	Sunshine inactive	At the end of sunshine with heating
No people present	Cooling active	Sunshine active	At the beginning of sunshine with cooling
No people present	Cooling active	Sunshine inactive	At the end of sunshine with cooling

States of the enlarged sun protection function with heating/cooling switchover

As described for the extended sun protection without automatic heating/cooling, the sunshine signal will be delayed, if a delay is configured in the ETS for this signal. In the same way, the presence signal can be evaluated independently after a delay, for example in order to debounce short time changes to the signal state.

The schematic diagram shows the interaction of the different communication objects

of the extended sun protection function in combination with the automatic heating/cooling function.. The diagram moreover illustrates the principle of incorporating sensor components into the automatic heating/cooling system.

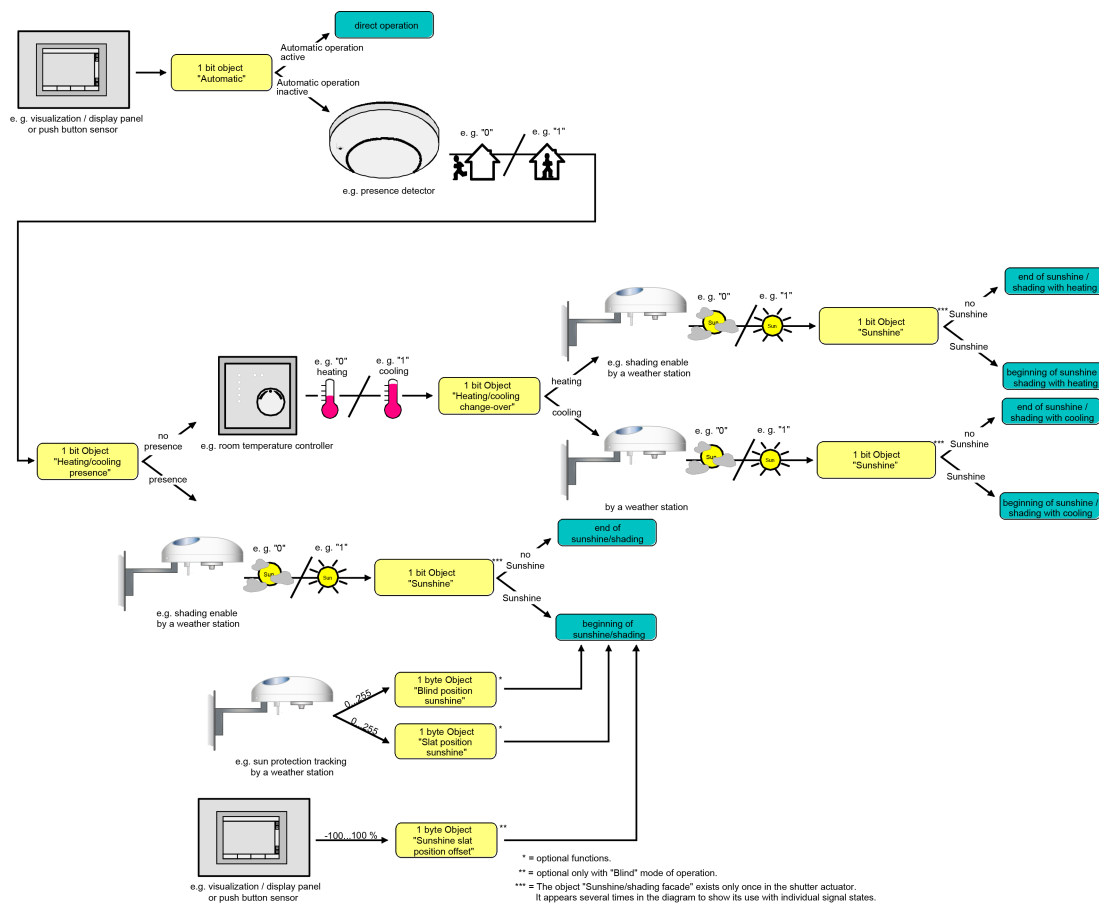

Image 19: Schematic diagram of automatic heating/cooling (for reasons of simplicity shown without disabling functions of the automatic or direct operation)

In accordance with the schematic diagram, the automatic heating/cooling function is only active when the automatic sun protection is active, too. Like in the extended sun protection mode without automatic heating/cooling, the automatic sun protection is activated via the "automatic sun protection" object depending on the configuration either immediately or only after a change of state has been detected for one of the signals "Presence", "Heating/cooling switchover" and "sunshine". After an ETS programming operation or after switch-on of the supply voltage of the actuator, the corresponding communication objects of the signals "Presence", "Heating/cooling switch-over" and "Sunshine" are initialised with ""0". In accordance with the preset polarity, the state of the sunshine and of the presence signal as well as the heating/cooling state will be determined and the corresponding reaction executed provided the automatic sun protection function is active. When the automatic sun protection is active, any change of state of the presence signal or any change in the heating/cooling signal will be evaluated immediately and the corresponding reaction executed.

The function diagram shows all possible functions of the enlarged sun protection with automatic heating/cooling. For reasons of clarity, the functions with a higher priority (manual control, forced position, safety function) are not shown in the diagram.

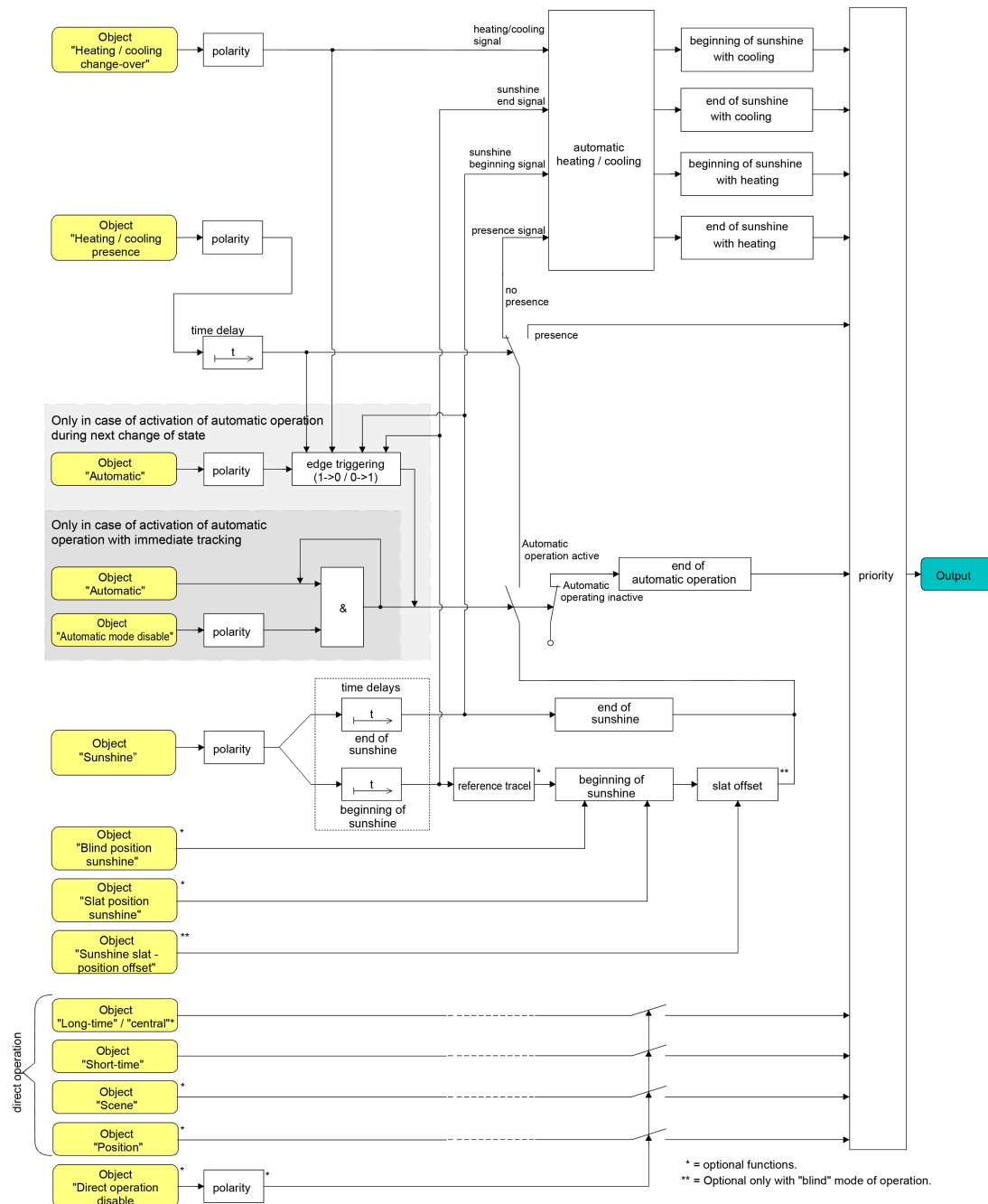

Image 20: Schematic function diagram of automatic heating/cooling

Presetting the polarity of the "Heating/cooling switchover" object

The telegram polarity of the "Heating / cooling changeover" object can be preset separately for each output. This means that an adaptation to the signals from existing room temperature controllers or from outside thermostats is possible.

Automatic heating/cooling must be enabled on the parameter page "Relay outputs... -> VBO... - General -> Sun protection -> Automatic heating/cooling" so that the parameters are visible.

- Set the parameter "Polarity of 'Heating/cooling switchover' object" to the required telegram polarity.
The heating/cooling signal is evaluated in accordance with the preset priority.
- i** An update of the "Heating / cooling switchover" object from active to active or from inactive to inactive shows generally no reaction. The behaviour of the output is only influenced if a change of state is being detected.
- i** After switch-on of the supply voltage of the actuator, the heating/cooling switchover is initialised with an object value of "0".

Presetting the polarity of the "Heating/cooling presence" object

The telegram polarity of the "Heating / cooling presence" object can be preset separately for each output. This means that an adaptation to the signals from existing KNX presence detectors or motion detectors is possible.

Automatic heating/cooling must be enabled on the parameter page "Relay outputs... -> VBO... - General -> Sun protection -> Automatic heating/cooling" so that the parameters are visible.

- Set the parameter "Polarity of 'Heating / cooling presence' object" to the required telegram polarity.
The presence signal is evaluated in accordance with the preset priority.
- i** An update of the "Heating / cooling presence" object from active to active or from inactive to inactive shows generally no reaction. The behaviour of the output is only influenced if a change of state is being detected.
- i** After switch-on of the supply voltage of the actuator, the heating/cooling presence control is initialised with an object value of "0".

Presetting a time delay for beginning and end of presence

The telegram received via the object "Heating / cooling presence" for transmission of the presence state (depending on polarity) can be evaluated with a time delay separately for each output.

Automatic heating/cooling must be enabled on the parameter page "Relay outputs... -> VBO... - General -> Sun protection -> Automatic heating/cooling" so that the parameters are visible.

- Set the parameter "delay at the beginning of presence" to the required delay time.
The telegram for activation of the presence mode will be evaluated with a delay corresponding to the setting.
- Set the parameter "delay at the end of presence" to the required delay time.
The telegram for deactivation of the presence mode will be evaluated with a delay corresponding to the setting.

- i** A setting of "0" in the parameters deactivates the respective delay time. In this case, the presence state is evaluated immediately on reception of a telegram.
- i** An update of the "Heating / cooling presence" object from active to active or from inactive to inactive shows generally no reaction. The behaviour of the output is only influenced if a change of state is being detected. An update of the presence signal alone does not result in the activation of automatic operation either.
- i** The time delay is started after an update of the "Heating / cooling presence" object also in those cases where the automatic operation is deactivated so that the newly received presence state may possibly also be processed with a delay, if the automatic operation is activated later on.

Presetting the reaction of automatic heating/cooling

The behaviour of the output when automatic heating/cooling is active can be configured separately for each output. A distinction is made between four states in the evaluation of the three 1-bit signals "Presence", "Heating/cooling switchover" and "Sunshine" ...

- "At the beginning of sunshine in heating operation",
- "At the end of sunshine in heating operation",
- "At the beginning of sunshine in cooling operation",
- "At the end of sunshine in cooling operation",

The reaction of an output can be set separately in the ETS for each of the named states. There is no difference between the parameter settings for the individual states. For this reason, the following section only describes the possible configuration as an example.

The reaction of automatic heating/cooling is set on the parameter page ""Relay outputs... -> VBO... - General -> sun protection -> automatic heating/cooling".

The automatic heating/cooling" must be enabled so that the parameters are visible.

- Set the parameter "At the beginning of sunshine..." and/or "At the end of sunshine..." to "no reaction".
During automatic heating/cooling, the relays of the output show no reaction. Any movements still in progress will still be finished.
- Set the parameter "At the beginning of sunshine..." and/or "At the end of sunshine..." to "raising" or "opening".
During automatic heating/cooling, the actuator raises the blind/shutter or opens the venting louver/roof window.
- Set the parameter "At the beginning of sunshine..." and/or "At the end of sunshine..." to "lowering" or "closing".
During automatic heating/cooling, the actuator lowers the blind/shutter or closes the venting louver/roof window.

- Set the parameter "At the beginning of sunshine..." and/or "At the end of sunshine..." to "stop".

During automatic heating/cooling, the actuator switches the relays of the output to the "stop" position. A travel movement, if any, will be interrupted.
- Set the parameter "At the beginning of sunshine..." and/or "At the end of sunshine..." to "Internal scene recall". The number of the scene to be recalled must be specified in the parameter "Scene number (1...64)".

During automatic heating/cooling, the actuator recalls the position value preset in the scene configuration for the output concerned. This is not a scene recall as in direct operation, but only an approach to the corresponding scene position value.
- Set the parameter "At the beginning of sunshine..." and/or "At the end of sunshine..." to "Fixed position".

During automatic heating/cooling, the actuator recalls the fixed position value for the output concerned.
- i** In the "Venetian blind" operating mode, the "fixed position" setting can only be selected in common for the height of the blind and for the slat position.
- "Fixed position" only: Set the parameter "Fixed position of Venetian blind", "Fixed position of roller shutter/awning" or "Fixed position of venting louver" to "as specified by parameter". Thereafter, set the parameter "Position of Venetian blind (0...100%)", "Position of roller shutter/awning (0...100%)" or "Position of venting louver (0...100%)" to the desired position.

During automatic heating/cooling, the output invariably approaches the configured position value.
- "Fixed position" only: Set the parameter "Fixed position of Venetian blind", "Fixed position of roller shutter/awning" or "Fixed position of venting louver" to "no change of current position".

With automatic heating/cooling, the last set position of the Venetian blind height, the shutter, awning or venting louver will be maintained.
- "Fixed position" and operating mode = "Venetian blind" only: Set the parameter "Fixed slat position (0...100%)" to the desired position value.

During automatic heating/cooling, the output invariably moves the slats to the configured position after the height of the Venetian blind has been adjusted.
- i** The parameterized reactions will not be executed if a function with a higher priority is active during automatic heating/cooling (e.g. safety function, forced position or manual control). The preset reaction will not be executed either, if the automatic sun protection is overridden on account of priority settings by a direct operation.

- i** "Internal scene recall" setting: For this setting, the scene function of the output must be enabled in the ETS. Otherwise, the positions approached during automatic heating/cooling are undefined positions. The scene position values stored in the actuator by a scene storage function will be approached as well. A delay configured for scene recalls has no influence on the recall of the scene value by the automatic heating/cooling function.

10.8.2 Sun protection function parameter

Relay outputs... -> VBO... - General -> Enabled functions

Sun protection function	Checkbox (yes / no)
The sun protection function of the Venetian blind output can be enabled here.	

Relay outputs... -> VBO... - General -> Sun protection

Type of sun protection	simple sun protection extended sun protection
------------------------	---

This parameter defines the scope of sun protection functions.

simple sun protection: Reduced scope of functions with standard configuration possibilities.

extended sun protection: Enlarged scope of functions including the possibilities of simple sun protection. In addition, the connected drive can be integrated in shading control systems depending on the position of the sun. In addition, automatic heating/cooling can be implemented.

Activation via	"Automatic" & next change of state object "Automatic" & immediate tracking object
----------------	---

This parameter defines how to activate the automatic mode and the reactions resulting from such activation.

"Automatic" & next change of state object: Automatic operation is activated as soon as the "Automatic" object is set to 'active' in accordance with polarity. A reaction at the output occurs, however, only after a new change of state has been signaled via "sunshine". In this case, the new state (beginning of sunshine or end of sunshine) determines the behaviour of the output.

"Automatic" & immediate tracking object: Automatic operation is activated as soon as the "Automatic" object is set to 'active' in accordance with polarity. The state of the "sunshine" object determines the behaviour of the output immediately (beginning of sunshine or end of sunshine).

The reception of a telegram 'Automatic mode inactive' at the "Automatic" object immediately ends the automatic mode in both cases. The behaviour in this case is defined by the parameter "At end".

Polarity of "Automatic" object	automatic mode: activated = 1; deactivated = 0 automatic mode: activated = 0; deactivated = 1
--------------------------------	---

This parameter defines the polarity of the automatic object.

disabling function	Checkbox (yes / no)
<p>The automatic mode can be disabled. When disabling is active, the automatic mode is aborted. It can only be reactivated, if a telegram according to "active" is written into the "Automatic" object. The objects "Automatic" and "Automatic mode disable" are logically combined (AND with feedback). An active parameter enables the disabling function and makes the disabling object visible.</p>	
Polarity of "Automatic mode disable" object	<p>Automatic mode: enabled = 1; disabled = 0 Automatic mode: enabled = 0; disabled = 1</p>
<p>This parameter defines the polarity of the automatic mode disable object. Disabling is active when a telegram with polarity 'disabled' is received. This parameter is only visible, if the parameter "disabling function" is activated.</p>	
Feedback	<p>no feedback feedback object is active signalling object feedback object is passive status object</p>
<p>The automatic mode of the extended sun protection has its own 1-bit feedback object for signalling on the KNX whether automatic mode is active or not. This parameter can be used to enable the feedback object and configure it further. No feedback: No feedback object is available for the automatic operation of the output concerned. feedback deactivated Feedback object is an active signalling object: The feedback and the object are activated. The object transmits actively (telegram transmission after change of state of automatic mode). Feedback object is a passive status object: The feedback and the object are activated. The object is passive (telegram transmission only as a response to 'Read' request).</p>	
Delay after bus voltage return	Checkbox (yes / no)
<p>The feedback telegram can be transmitted to the KNX with a delay after bus voltage return or after programming with the ETS. An activated parameter causes the delay time of the feedback in case of bus voltage return. The delay time is configured under "General -> General Venetian blind outputs". This parameter is only visible in case of an actively transmitting feedback object.</p>	

<p>At the end</p>	<p>no reaction raising / opening lowering / closing stop tracking the position</p>
<p>This parameter defines the behaviour of the output at the end of automatic operation and also at the beginning of an automatic operation disable.</p> <p>no reaction: At the end of automatic operation, the sun protection function is ended and the relay of the output shows no reaction. Any travel movements still in progress at this instant will still be finished.</p> <p>raising / opening the louver: At the end of automatic operation, the actuator terminates the sun protection and raises the blind/shutter or opens the venting louver/roof window.</p> <p>lowering / closing the louver: At the end of automatic operation, the actuator terminates the sun protection and lowers the blind/shutter or closes the venting louver/roof window.</p> <p>stop: At the end of automatic operation the sun protection is terminated and the actuator switches the relays of the output to "stop". A travel movement, if any, will be interrupted.</p> <p>tracking the position: At the end of automatic operation, the output will be set to the state last adjusted before the automatic sun protection or to the state tracked and internally stored during the automatic sun protection. The position objects, the long-time object and the scene function are tracked.</p> <p>The behaviour preset in this parameter will only be executed, if no function with a higher priority (e.g. safety) is activated at the end of automatic operation.</p>	
<p>Priority of sun protection with respect to direct operation</p>	<p>same priority higher priority lower priority</p>
<p>This parameter defines the priority of the sun protection function with respect to direct operation.</p> <p>same priority: The sun protection can be overridden by direct operation and vice versa. Only after the next reception of a "sun is shining" signal will the sun protection mode be activated again.</p> <p>higher priority: The sun protection has the higher priority and cannot be aborted by a direct operation.</p> <p>lower priority: The direct operation has the higher priority and cannot be aborted by sun protection. The sun protection can be activated only after an enabling movement into the upper end position initiated by a direct operation has occurred without interruption.</p> <p>Direct operation = long-time/short-time operation, positioning via objects, scenes, central.</p> <p>The parameter with the named settings and meanings is only available in simple sun protection.</p>	

Priority of sun protection with respect to direct operation	same priority higher priority lower priority
<p>This parameter defines the priority of automatic operation with respect to direct operation. The selected priority affects the evaluation of the sunshine signal in the automatic mode and not the automatic mode itself.</p> <p>same priority: The evaluation of the sunshine signal in the automatic mode can be overridden by a direct operation. In the same way, a direct operation is overridden by the reception of a new sunshine telegram.</p> <p>higher priority: The automatic mode has the higher priority and cannot be aborted by a direct operation irrespective of the state of the sunshine signal. A direct operation will be possible again only after the automatic mode is terminated.</p> <p>lower priority: The direct operation has the higher priority and cannot be aborted by a sunshine signal in the automatic mode. The sunshine signal is evaluated again only after an enabling movement into the upper end position initiated by a direct operation has occurred without interruption and only if the automatic mode is activated and not disabled at this time.</p> <p>Direct operation = long-time/short-time operation, positioning via objects, scenes, central.</p> <p>The parameter with the named settings and meanings is only visible in the extended sun protection.</p>	

Object polarity "sunshine"	sunshine = 1; no sunshine = 0 sunshine = 0; no sunshine = 1
<p>This parameter defines the polarity of the input object "sunshine".</p>	

Disabling function for direct operation	Checkbox (yes / no)
<p>Direct operation can be disabled. When disabling is active, a direct operation can – independently of the preset priority – never abort a sun protection function. In this case, direct operation is disabled in other functions, too.</p> <p>An activated parameter enables the disabling function and makes the disabling object visible.</p> <p>Direct operation = long-time/short-time operation, positioning via objects, scenes, central.</p>	

Polarity of "Direct operation disable" object	direct operation: enabled = 1; disabled = 0 direct operation: enabled = 0; disabled = 1
<p>This parameter defines the polarity of the disabling object for direct operation. Disabling is active when a telegram with polarity 'disabled' is received.</p> <p>This parameter is only visible, if the parameter "Direct operation disable" is activated.</p>	

Relay outputs... -> VBO... General -> Sunshine -> Sun protection start

Delay at the beginning of sunshine Minutes (0...59)	0...59
The telegram received via the object "Sunshine" for activation of shading (depending on polarity) can be evaluated with a time delay. Setting the delay time minutes.	
Seconds (0...59)	0... 30 ...59
Setting the delay time seconds. A time setting of "0" in the parameters deactivates the respective delay time. In this case, the state of shading is evaluated immediately.	

At the beginning of sunshine	no reaction raising lowering stop internal scene recall venetian blind or slat position fixed venetian blind position fixed / slat position variable slat position fixed / Venetian blind position variable Venetian blind and slat position variable
<p>This parameter defines the behaviour of the output at the beginning of shading – if applicable, after the end of the delay time.</p> <p>no reaction: At the beginning of shading, the output switches over to sun protection while the relays of the output show no reaction. Any travel movements still in progress at this instant will still be finished.</p> <p>raising: At the beginning of shading, the actuator raises the blind/shutter.</p> <p>lowering: At the beginning of shading, the actuator lowers the blind/shutter.</p> <p>stop: At the beginning of shading, the actuator switches the relays of the output to the "stop" position. A travel movement, if any, will be interrupted.</p> <p>Internal scene recall: At the beginning of shading, the actuator recalls the position values for the affected output which were preset in the scene configuration. This is not a scene recall as in direct operation, but only an approach of the corresponding scene position values.</p> <p>Venetian blind or slat position fixed: At the beginning of shading, the output moves to a configured fixed Venetian blind and slat position.</p> <p>venetian blind position fixed / slat position variable: At the beginning of shading, the output controls the approach to a configured fixed Venetian blind position and to slat position preset by a separate object and thus variable.</p> <p>slat position fixed / Venetian blind position variable: At the beginning of shading, the output controls the approach to a configured fixed slat position and to a Venetian blind position preset by a separate object and thus variable.</p> <p>Venetian blind and slat position variable: At the beginning of shading, the output controls the approach to the Venetian blind and slat positions preset by two separate objects and thus variable.</p> <p>This parameter is only visible in the venetian blind operating mode.</p>	

At the beginning of sunshine	no reaction raising lowering stop internal scene recall fixed position variable position
<p>This parameter defines the behaviour of the output at the beginning of shading – if applicable, after the end of the delay time.</p> <p>no reaction: At the beginning of shading, the output switches over to sun protection while the relays of the output show no reaction. Any travel movements still in progress at this instant will still be finished.</p> <p>raising: At the beginning of shading, the actuator raises the blind/shutter.</p> <p>lowering: At the beginning of shading, the actuator lowers the blind/shutter.</p> <p>stop: At the beginning of shading, the actuator switches the relays of the output to the "stop" position. A travel movement, if any, will be interrupted.</p> <p>Internal scene recall: At the beginning of shading, the actuator recalls the position values for the affected output which were preset in the scene configuration. This is not a scene recall as in direct operation, but only an approach of the corresponding scene position values.</p> <p>fixed position: At the beginning of shading, the output controls the approach to a configured fixed position.</p> <p>variable position: At the beginning of shading, the output controls the approach to a position preset by a separate object and thus variable.</p> <p>This parameter is only visible in the shutter/awning operating mode.</p>	

At the beginning of sunshine	no reaction open close stop internal scene recall fixed position variable position
------------------------------	---

This parameter defines the behaviour of the output at the beginning of shading – if applicable, after the end of the delay time.

no reaction: At the beginning of shading, the output switches over to sun protection while the relays of the output show no reaction. Any travel movements still in progress at this instant will still be finished.

open: At the beginning of shading, the actuator opens the venting louver/roof window.

close: At the beginning of shading, the actuator closes the venting louver/roof window.

stop: At the beginning of shading, the actuator switches the relays of the output to the "stop" position. A travel movement, if any, will be interrupted.

Internal scene recall: At the beginning of shading, the actuator recalls the position values for the affected output which were preset in the scene configuration. This is not a scene recall as in direct operation, but only an approach of the corresponding scene position values.

fixed position: At the beginning of shading, the output controls the approach to a configured fixed position.

variable position: At the beginning of shading, the output controls the approach to a position preset by a separate object and thus variable.

This parameter is only visible in the "venting louver/roof window" operating mode.

Internal scene	Scene 1 Scene 2 ... Scene 64
----------------	--

This parameter defines the internal scene which is recalled at the beginning of shading.

This parameter is only visible, if the parameter "At the beginning of sunshine" is set to "internal scene recall".

Fixed Venetian blind position	<p>same as configured value no change in current position</p>
<p>The fixed Venetian blind position at the beginning of shading can either be preset statically by a separate parameter or basically adjusted to the value prevailing at the time of shading activation, i.e. remain unchanged.</p> <p>same as configured value: At the beginning of shading, the configured Venetian blind position will be approached.</p> <p>no change in current position: At the beginning of shading, the current Venetian blind position will be maintained. In this case, the output behaves as if only the slat were positioned as a result of shading.</p> <p>This parameter is only visible, if the Venetian blind is to approach a fixed position at the beginning of shading.</p> <p>This parameter is only visible in the "Venetian blind with slat" operating mode.</p>	
Position of blind (0...100 %)	0... 50 ...100
<p>This parameter sets the fixed position of the Venetian blind to be approached at the beginning of shading.</p> <p>This parameter is only visible, if the parameter "Fixed position of Venetian blind" is set to "as specified by parameter".</p> <p>This parameter is only visible in the "Venetian blind with slat" operating mode.</p>	
Fixed position of slat (0...100 %)	0... 50 ...100
<p>This parameter sets the fixed position of the slat to be approached at the beginning of shading and, as the case may be, after positioning of the Venetian blind.</p> <p>This parameter is only visible, if the slat is to approach a fixed position at the beginning of shading.</p> <p>This parameter is only visible in the "Venetian blind with slat" operating mode.</p>	
Fixed roller shutter / awning position	<p>same as configured value no change in current position</p>
<p>The fixed position of the roller shutter or awning at the beginning of shading can either be preset statically by a separate parameter or basically adjusted to the value prevailing at the time of shading activation, i.e. remain unchanged.</p> <p>same as configured value: At the beginning of shading, the configured shutter or awning position will be approached.</p> <p>no change in current position: At the beginning of shading, the current shutter or awning position will be maintained. Any movements in progress at the time of shading activation will be finished.</p> <p>This parameter is only visible when the shutter or awning should approach a fixed position value at the beginning of sun shading.</p> <p>This parameter is only visible in the shutter/awning operating mode.</p>	

Position of shutter/awning (0...100 %)	0... 50 ...100
<p>This parameter sets the fixed position of the shutter or awning to be approached at the beginning of shading.</p> <p>This parameter is only visible, if the parameter "Fixed position of shutter / awning" is set to "as specified by parameter".</p> <p>This parameter is only visible in the shutter/awning operating mode.</p>	
Fixed position of venting louvre	same as configured value no change in current position
<p>The fixed venting louvre position at the beginning of shading can either be preset statically by a separate parameter or basically adjusted to the value prevailing at the time of shading activation, i.e. remain unchanged.</p> <p>same as configured value: At the beginning of shading, the configured venting louver position will be approached.</p> <p>no change in current position: At the beginning of shading, the current venting louver position will be maintained. Any movements in progress at the time of shading activation will be finished.</p> <p>This parameter is only visible if the venting louvre is to approach a fixed position at the beginning of shading.</p> <p>This parameter is only visible in the "venting louver/roof window" operating mode.</p>	
Position of venting louver (0...100 %)	0... 50 ...100
<p>This parameter sets the fixed position of the venting louvre to be approached at the beginning of shading.</p> <p>This parameter is only visible, if the parameter "Fixed position of venting louver" is set to "as specified by parameter".</p> <p>This parameter is only visible in the "venting louver/roof window" operating mode.</p>	
Reference travel before every sun protection positioning operation	Checkbox (yes / no)
<p>A forced reference travel of the drive is performed before sun protection positioning. A reference movement is a positioning movement into the upper end position or into the completely open position. By means of a forced reference movement, drives connected to different outputs can be synchronised. If no synchronising movement is forced, the actuator performs a reference movement only once after return of the power supply.</p>	

Offset of the slat position during sunshine	no offset offset as configured offset as configured and via object
<p>For manual adjustment of the slat angle during a shading or sun position tracking operation, a slat offset can be preset. The offset corrects the preset slat angle in positive or in negative direction. The lighting conditions in a room can thus be individually adapted by persons present in the room.</p> <p>no offset: Offset correction is deactivated.</p> <p>Offset as parameter: The slat offset is statically preset by means of a fixed parameter value.</p> <p>Offset as parameter and via object: The slat offset is preset by a fixed parameter value and can be dynamically adapted via a separate communication object. This parameter is only visible, if the slat is to approach a fixed or a variable position at the beginning of shading.</p> <p>This parameter is only visible in the "Venetian blind with slat" operating mode.</p>	

Offset slat position (-100..100 %)	-100...0...100
<p>This parameter is used for setting the slat offset. The value specified in this parameter is added at the beginning of shading to the current slat angle. Even with offset correction, the 0...100% slat position limits cannot be overstepped. It should be noted that the configured offset value can be overwritten by the object after reception of a dynamic value.</p> <p>This parameter is only visible, if the parameter "offset with fixed and variable slat position" is set to "offset as configured" or to "offset as configured and via object".</p> <p>This parameter is only visible in the "Venetian blind with slat" operating mode.</p>	

Store in case of bus voltage failure	Checkbox (yes / no)
<p>If the offset is preset via the object, this parameter defines whether the received value is to be stored in the actor's NV memory.</p> <p>Parameter activated: The value received via the object will be stored permanently in the actuator in case of bus voltage failure. The originally configured offset value is definitely overwritten in the process.</p> <p>Parameter deactivated: The value received via the object will only be stored temporarily in volatile memory. This only replaces the configured value until the actuator is reinitialised (return of bus voltage). After the initialisation, the offset value configured in the ETS will be used again.</p> <p>This parameter is only visible, if the parameter "Offset with fixed and variable slat position" is set to "offset as configured and via object".</p> <p>This parameter is only visible in the "Venetian blind with slat" operating mode.</p>	

Relay outputs... -> VBO... - General -> Sunshine -> Sun protection end

Delay at the end of sunshine Minutes (0...59)	0...59
<p>The telegram received via the object "Sunshine" for deactivation of shading (depending on polarity) can be evaluated with a time delay.</p> <p>Setting the delay time minutes.</p>	

Seconds (0...59)	0... 30 ...59
<p>Setting the delay time seconds. A time setting of "0" in the parameters deactivates the respective delay time. In this case, the state of shading is evaluated immediately.</p>	
At the end of sunshine	no reaction raising / opening lowering / closing stop tracking the position
<p>This parameter defines the behaviour of the output at the end of shading – if applicable, after the end of the delay time.</p> <p>no reaction: At the end of shading, the output quits the sun protection mode and the relays of the output show no reaction. Any travel movements still in progress at this instant will still be finished.</p> <p>raising / opening: The actuator raises the blind/shutter or opens the venting louver/ roof window at the end of shading.</p> <p>lowering / closing: The actuator lowers the blind/shutter or closes the venting louver/ roof window at the end of shading.</p> <p>stop: At the end of shading, the actuator switches the relays of the output to the "stop" position. A travel movement, if any, will be interrupted.</p> <p>tracking the position: At the end of shading, the output will be set to the state last adjusted before sun protection or to the state tracked and internally stored during sun protection. The position objects, the long-time object and the scene function are tracked.</p> <p>The behaviour preset in this parameter will only be executed if no function with a higher priority (e.g. safety) is activated at the end of shading. This parameter is only visible in the simple sun protection.</p>	

At the end of sunshine	no reaction raising lowering stop internal scene recall venetian blind or slat position fixed
<p>This parameter defines the behaviour of the output at the end of shading – if applicable, after the end of the delay time.</p> <p>no reaction: At the end of shading, the relays of the output show no reaction. Any travel movements still in progress at this instant will still be finished.</p> <p>raising: At the end of shading, the actuator raises the blind/shutter.</p> <p>lowering: At the end of shading, the actuator lowers the blind/shutter.</p> <p>stop: At the end of shading, the actuator switches the relays of the output to the "stop" position. A travel movement, if any, will be interrupted.</p> <p>Internal scene recall: At the end of shading, an internal scene of the actuator is recalled.</p> <p>Venetian blind or slat position fixed: At the end of shading, the output moves to a configured fixed Venetian blind and slat position.</p> <p>This parameter is only visible in the extended sun protection.</p> <p>This parameter is only visible in the venetian blind operating mode.</p> <p>This parameter does not define the behaviour of the output at the end of automatic operation (cf. parameter "At end")!</p>	

At the end of sunshine	no reaction raising lowering stop internal scene recall fixed position
<p>This parameter defines the behaviour of the output at the end of shading – if applicable, after the end of the delay time.</p> <p>no reaction: At the end of shading, the relays of the output show no reaction. Any travel movements still in progress at this instant will still be finished.</p> <p>raising: At the end of shading, the actuator raises the blind/shutter.</p> <p>lowering: At the end of shading, the actuator lowers the blind/shutter.</p> <p>stop: At the end of shading, the actuator switches the relays of the output to the "stop" position. A travel movement, if any, will be interrupted.</p> <p>Internal scene recall: At the end of shading, an internal scene of the actuator is recalled.</p> <p>fixed position: At the end of shading, the output controls the approach to a configured fixed position.</p> <p>This parameter is only visible in the extended sun protection.</p> <p>This parameter is only visible in the shutter/awning operating mode.</p> <p>This parameter does not define the behaviour of the output at the end of automatic operation (cf. parameter "At end")!</p>	

At the end of sunshine	no reaction open close stop internal scene recall fixed venting louvre position
------------------------	---

This parameter defines the behaviour of the output at the end of shading – if applicable, after the end of the delay time.

no reaction: At the end of shading, the relays of the output show no reaction. Any travel movements still in progress at this instant will still be finished.

open: At the end of shading, the actuator opens the venting louver/ roof window.

close: At the end of shading, the actuator closes the venting louver/ roof window.

stop: At the end of shading, the actuator switches the relays of the output to the "stop" position. A travel movement, if any, will be interrupted.

Internal scene recall: At the end of shading, an internal scene of the actuator is recalled.

fixed position: At the end of shading, the output controls the approach to a configured fixed position.

This parameter is only visible in the extended sun protection.

This parameter is only visible in the "venting louver/roof window" operating mode.

This parameter does not define the behaviour of the output at the end of automatic operation (cf. parameter "At end")!

Internal scene	Scene 1 Scene 2 ... Scene 64
----------------	--

This parameter defines the internal scene which is recalled at the end of shading.

This parameter is only visible, if the parameter "At the end of sunshine" is set to "internal scene recall".

Fixed Venetian blind position	same as configured value no change in current position
<p>The fixed Venetian blind position at the end of shading can either be preset statically by a separate parameter or basically remain at the value set or tracked by the shading operation.</p> <p>same as configured value: At the end of shading, the configured Venetian blind position will be approached.</p> <p>no change in current position: At the end of shading, the current Venetian blind position will be maintained. In this case, the output behaves as if only the slat were positioned as a result of the end of shading.</p> <p>This parameter is only visible, if the Venetian blind is to approach a fixed position at the end of shading.</p> <p>This parameter is only visible in the venetian blind operating mode.</p>	
Position of blind (0...100 %)	0... 50 ...100
<p>This parameter sets the fixed position of the Venetian blind to be approached at the end of shading.</p> <p>This parameter is only visible, if the parameter "Fixed position of Venetian blind" is set to "as specified by parameter".</p> <p>This parameter is only visible in the "Venetian blind with slat" operating mode.</p>	
Fixed position of slat (0...100 %)	0... 50 ...100
<p>This parameter sets the fixed position of the slat to be approached at the end of shading and, as the case may be, after positioning of the Venetian blind.</p> <p>This parameter is only visible, if the slat is to approach a fixed position at the beginning of shading.</p> <p>This parameter is only visible in the "Venetian blind with slat" operating mode.</p>	
Fixed roller shutter / awning position	same as configured value no change in current position
<p>The fixed position of the roller shutter or awning at the end of shading can either be preset statically by a separate parameter or basically adjusted to the value prevailing at the time of shading activation, i.e. remain unchanged.</p> <p>same as configured value: At the end of shading, the configured shutter or awning position will be approached.</p> <p>no change in current position: At the end of shading, the current shutter or awning position will be maintained. Any movements in progress at the time of shading activation will be finished.</p> <p>This parameter is only visible, if the shutter or awning is to approach a fixed position at the end of shading.</p> <p>This parameter is only visible in the shutter/awning operating mode.</p>	

Position of shutter/awning (0...100 %)	0... 50 ...100
<p>This parameter sets the fixed position of the shutter or awning to be approached at the end of shading.</p> <p>This parameter is only visible, if the parameter "Fixed position of shutter / awning" is set to "as specified by parameter".</p> <p>This parameter is only visible in the shutter/awning operating mode.</p>	

Fixed position of venting louvre	same as configured value no change in current position
<p>The fixed venting louver position at the end of shading can either be preset statically by a separate parameter or basically adjusted to the value prevailing at the time of shading activation, i.e. remain unchanged.</p> <p>same as configured value: At the end of shading, the configured venting louver position will be approached.</p> <p>no change in current position: At the end of shading, the current venting louver position will be maintained. Any movements in progress at the time of shading activation will be finished.</p> <p>This parameter is only visible if the venting louver is to approach a fixed position at the end of shading.</p> <p>This parameter is only visible in the "venting louver/roof window" operating mode.</p>	

Position of venting louver (0...100 %)	0... 50 ...100
<p>This parameter sets the fixed position of the venting louver to be approached at the end of shading.</p> <p>This parameter is only visible, if the parameter "Fixed position of venting louver" is set to "as specified by parameter".</p> <p>This parameter is only visible in the "venting louver/roof window" operating mode.</p>	

Relay outputs... -> VBO... - General -> Sun protection -> Automatic heating/cooling

Automatic heating/cooling	Checkbox (yes / no)
<p>This parameter can be used to activate the automatic heating/cooling function. The automatic heating/cooling function adds a presence detection function to the extended sun protection mode. If a person is present, the extended sun protection is executed as described. If nobody is present, however, the Venetian blinds, shutters, awnings, venting louvers or roof windows can be operated in such a way that these devices support the heating or cooling function of the building.</p> <p>When the function is enabled, the other parameters and objects are visible.</p> <p>The automatic heating/cooling function can only be activated in the extended sun protection mode.</p> <p>Moreover, the automatic heating/cooling function is only active when the automatic mode of the extended sun protection function is activated.</p>	

Polarity of "Heating/cooling changeover" object	cooling = 0; heating = 1 cooling = 1; heating = 0
<p>This parameter defines the polarity of the object for heating/cooling switchover. This object is linked, for instance, with room temperature controllers or outside thermometers.</p> <p>The heating/cooling switchover is initialised after the return of the supply voltage of the actuator according to the object value "0" and the set polarity.</p> <p>This parameter is visible only if automatic heating/cooling is enabled.</p>	
Polarity of "Heating/cooling presence" object	no presence = 0; presence = 1 no presence = 1; presence = 0
<p>This parameter defines the polarity of the object for presence control in case of automatic heating/cooling. This object is linked, for example, with KNX presence detectors.</p> <p>The heating/cooling presence control is initialised after the return of the supply voltage of the actuator according to the object value "0" and the set polarity.</p> <p>This parameter is visible only if automatic heating/cooling is enabled.</p>	
Delay at the beginning of presence Minutes (0...59)	0...59
<p>The telegram received via the object "Heating/cooling presence" for activation of the presence function (in acc. with polarity) can be evaluated with a time delay.</p> <p>Setting the delay time minutes.</p>	
Seconds (0...59)	0...30...59
<p>Setting the delay time seconds.</p> <p>A time setting of "0" in the parameters deactivates the respective delay time. In this case, the state of the presence object is evaluated immediately.</p> <p>These parameters are visible only if automatic heating/cooling is enabled.</p>	
Delay at the end of presence Minutes (0...59)	0...59
<p>The telegram received via the object "Heating/cooling presence" for deactivation of the presence function (in acc. with polarity) can be evaluated with a time delay.</p> <p>Setting the delay time minutes.</p>	
Seconds (0...59)	0...30...59
<p>Setting the delay time seconds.</p> <p>A time setting of "0" in the parameters deactivates the respective delay time. In this case, the state of the presence object is evaluated immediately.</p> <p>These parameters are visible only if automatic heating/cooling is enabled.</p>	

In heating mode/cooling mode At the beginning of sunshine At the end of sunshine	no reaction raising lowering internal scene recall venetian blind or slat position fixed
<p>This parameter defines the behaviour of the output at the end / at the beginning of sunshine / shading with heating / cooling – if applicable, after the end of the delay time.</p> <p>no reaction: The relays of the output show no reaction. Any travel movements still in progress at this instant will still be finished.</p> <p>raising: The actuator raises the blind/shutter.</p> <p>lowering: The actuator lowers the blind/shutter.</p> <p>internal scene recall: An internal scene of the actuator is recalled.</p> <p>Venetian blind or slat position fixed: The output moves to a configured fixed Venetian blind and slat position.</p> <p>This parameter is visible only if automatic heating/cooling is enabled.</p> <p>This parameter is only visible in the "Venetian blind with slats" operating mode.</p> <p>*: The parameter settings for heating or cooling or beginning or end must be parameterized separately. The setting options - also for the follow-up parameters - are identical in all cases.</p>	

In heating mode/cooling mode At the beginning of sunshine At the end of sunshine	no reaction raising lowering internal scene recall fixed position
<p>This parameter defines the behaviour of the output at the end / at the beginning of sunshine / shading with heating / cooling – if applicable, after the end of the delay time.</p> <p>no reaction: The relays of the output show no reaction. Any travel movements still in progress at this instant will still be finished.</p> <p>raising: The actuator raises the blind/shutter.</p> <p>lowering: The actuator lowers the blind/shutter.</p> <p>internal scene recall: An internal scene of the actuator is recalled.</p> <p>fixed position: The output controls the approach to a configured fixed position.</p> <p>This parameter is visible only if automatic heating/cooling is enabled.</p> <p>This parameter is only visible in the shutter/awning operating mode.</p> <p>*: The parameter settings for heating or cooling or beginning or end must be parameterized separately. The setting options - also for the follow-up parameters - are identical in all cases.</p>	

<p>In heating mode/cooling mode At the beginning of sunshine At the end of sunshine</p>	<p>no reaction opening the louvre closing the louvre internal scene recall fixed position</p>
<p>This parameter defines the behaviour of the output at the end / at the beginning of sunshine / shading with heating / cooling – if applicable, after the end of the delay time.</p> <p>no reaction: The relays of the output show no reaction. Any travel movements still in progress at this instant will still be finished.</p> <p>opening the louver: The actuator opens the venting louver.</p> <p>closing the louver: The actuator closes the venting louver.</p> <p>internal scene recall: An internal scene of the actuator is recalled.</p> <p>fixed position: The output controls the approach to a configured fixed position. This parameter is visible only if automatic heating/cooling is enabled. This parameter is only visible in the "venting louver/roof window" operating mode.</p> <p>*: The parameter settings for heating or cooling or beginning or end must be parameterized separately. The setting options - also for the follow-up parameters - are identical in all cases.</p>	
<p>Scene number (1...64)</p>	<p>1...64</p>
<p>This parameter defines the number of the internal scene which is recalled. This parameter is only visible, if the parameters "At the beginning of sunshine" and/or "At the end of sunshine" of the automatic heating/cooling are set to "internal scene recall".</p>	
<p>Fixed Venetian blind position</p>	<p>same as configured value no change in current position</p>
<p>The fixed Venetian blind position in case of automatic heating/cooling can either be preset statically by a separate parameter or basically remain at the current value.</p> <p>same as configured value: The configured Venetian blind position will be approached.</p> <p>no change in current position: The current Venetian blind position will be maintained. In this case, the output behaves as if only the slat were positioned. This parameter is only visible, if the Venetian blind is to approach a fixed position in case of automatic heating/cooling. This parameter is only visible in the "Venetian blind with slats" operating mode.</p>	
<p>Position of blind (0...100 %)</p>	<p>0...50...100</p>
<p>This parameter sets the fixed position of the Venetian blind to be approached in case of automatic heating/cooling. This parameter is only visible, if the parameter "Fixed position of Venetian blind" is set to "as specified by parameter". This parameter is only visible in the "Venetian blind with slats" operating mode.</p>	

Fixed position of slat (0...100 %)	0... 50 ...100
<p>This parameter sets the fixed position of the slat to be approached in case of automatic heating/cooling and, as the case may be, after positioning of the Venetian blind.</p> <p>This parameter is only visible, if the slat is to approach a fixed position with automatic heating/cooling.</p> <p>This parameter is only visible in the "Venetian blind with slats" operating mode.</p>	
Fixed roller shutter / awning position	same as configured value no change in current position
<p>The fixed roller shutter/awning position in case of automatic heating/cooling can either be preset statically by a separate parameter or basically remain at the current value.</p> <p>same as configured value: The configured shutter or awning position will be approached.</p> <p>no change in current position: The current shutter/awning position will be maintained.</p> <p>This parameter is only visible, if the shutter or awning is to approach a fixed position in case of automatic heating/cooling.</p> <p>This parameter is only visible in the shutter/awning operating mode.</p>	
Position of shutter/awning (0...100 %)	0... 50 ...100
<p>This parameter sets the fixed position of the shutter or awning to be approached with automatic heating/cooling.</p> <p>This parameter is only visible, if the parameter "Fixed position of shutter / awning" is set to "as specified by parameter".</p> <p>This parameter is only visible in the shutter/awning operating mode.</p>	
Fixed position of venting louvre	same as configured value no change in current position
<p>The fixed venting louver position in case of automatic heating/cooling can either be preset statically by a separate parameter or basically remain at the current value.</p> <p>same as configured value: The configured venting louver position will be approached.</p> <p>no change in current position: The current venting louver position will be maintained.</p> <p>This parameter is only visible, if the venting louver is to approach a fixed position in case of automatic heating/cooling.</p> <p>This parameter is only visible in the "venting louver/roof window" operating mode.</p>	
Position of venting louver (0...100 %)	0... 50 ...100
<p>This parameter sets the fixed position of the venting louver to be approached in case of automatic heating/cooling.</p> <p>This parameter is only visible, if the parameter "Fixed position of venting louver" is set to "as specified by parameter".</p> <p>This parameter is only visible in the "venting louver/roof window" operating mode.</p>	

10.8.3 Object sun protection function

Object no.	Function	Name	Type	DPT	Flag
29, 53...	Sun protection - automatic mode	Venetian blind... - Input	1-bit	1,003	C, (R), W, -, A

1-bit object for activation or deactivation of the automatic sun protection in the extended sun protection mode ("1" = automatic mode activated / "0" = automatic mode deactivated).

Object no.	Function	Name	Type	DPT	Flag
30, 54...	Sun protection - automatic mode disable	Venetian blind... - Input	1-bit	1,003	C, (R), W, -, A

1-bit object for disabling of the automatic sun protection in the extended sun protection mode. The polarity can be configured. The object is only available if the disabling function of the automatic mode is enabled in the extended sun protection.

Object no.	Function	Name	Type	DPT	Flag
31, 55...	Sun protection - direction operation disable	Venetian blind... - Input	1-bit	1,003	C, (R), W, -, A

1-bit object for disabling direct operation in the extended sun protection mode (direct operation = Move / Step / Position / Scene / Central). The polarity can be configured.

Object no.	Function	Name	Type	DPT	Flag
32, 56...	Sunshine	Venetian blind... - Input	1-bit	1,001	C, (R), W, -, A

1-bit object for activation or deactivation of sun shading in the simple or extended sun protection mode (sun / no sun). The polarity can be configured.

Object no.	Function	Name	Type	DPT	Flag
33, 57...	Sun protection - ...position	Venetian blind... - Input	1 bytes	5,001	C, (R), W, -, A

1-byte object for presetting a variable position value (0...255) for the height of the Venetian blind or shutter or the venting louver/roof window position in direct operation when the sun protection is active.

Object no.	Function	Name	Type	DPT	Flag
34, 58...	Sun protection - slat position	Venetian blind... - Input	1 bytes	5,001	C, (R), W, -, A

1-byte object for presetting a variable slat position value (0...255) when the sun protection is active.

Object no.	Function	Name	Type	DPT	Flag
35, 59...	Sun protection - off-set slat position	Venetian blind... - Input	1 bytes	6,001	C, (R), W, -, A

1-byte object for presetting a slat position angle (- 100 % ... +100 % / smaller or larger position angles are treated as + or - 100 %) for 'manual' readjustment of the slat position when the sun protection is active.

Object no.	Function	Name	Type	DPT	Flag
36, 60...	Heating/cooling presence	Venetian blind... - Input	1-bit	1,018	C, (R), W, -, A

1-bit object for activation of Presence mode during automatic heating/cooling. The polarity can be configured. This object is generally linked with presence detectors.

Object no.	Function	Name	Type	DPT	Flag
37, 61...	Heating/cooling change-over	Venetian blind... - Input	1-bit	1,100	C, (R), W, -, A

1-bit object for switching over between heating and cooling operation during automatic heating/cooling. The polarity can be configured. This object is generally linked with room temperature controllers (object "heating/cooling switchover").

Object no.	Function	Name	Type	DPT	Flag
42, 66...	Sun position - automatic feedback	Venetian blind... - Output	1-bit	1,002	C, R, -, T, A

1-bit object for feedback of active automatic operation in extended sun protection ("0" = Automatic operation not active - direct operation active / "1" = Automatic operation active).

The object is only available if the feedback of the automatic mode is enabled in the extended sun protection.

10.9 Scene function

An actuator can hold up to 64 scenes for each output and store scene position values for the height of a Venetian blind, shutter or awning or the venting louver/roof window position. In the 'Venetian blinds' operating mode, the user can also preset slat positions. The scene values are recalled or stored via a separate scene extension object. The data point type of the extension object permits addressing of all 64 scenes.

The scene function must be enabled on the parameter page "Relay outputs... -> VBO... - General -> Enabled functions" for each Venetian blind output, in order for the required communication objects and parameters (on the parameter page "Relay outputs... -> VBO... - General -> Scenes") to become visible.

The scene configuration selected in the parameterization decides whether the number of scenes is either variable (1 ... 64) or alternatively fixed to the maximum (64).

- Scene configuration = "variable (1 ... 64 scenes)"
With this setting, the number of scenes used can be selected anywhere in the range 1 to 64. The parameter "Number of scenes" decides how many scenes are visible for the switching output in the ETS and can therefore be used. It is possible to specify which scene number (1 ... 64) controls each scene.
- Scene configuration = "fixed (64 scenes)"
With this setting, all scenes are always visible and can therefore be used. The scenes are controlled via permanently assigned scene numbers (1 ... 64) (scene number 1 -> scene 1, scene number 2 -> scene 2 ...). If necessary, individual scenes can be deactivated.

Like the output control via short time, long time, central or position telegrams, the scene function should be assigned to direct operation. For this reason, a recalled scene position can at any time be overridden by a manual control, a forced position or a safety function. The scene position last recalled can also be readjusted by other telegrams of the direct operation mode. The priority of direct operation and also of the scene function can be configured with respect to the sun protection function (cf. "Sun protection function").

Presetting a scene recall delay

Each scene recall of an output can optionally also be delayed. With this feature, dynamic scene sequences can be configured if several scene outputs are combined with cyclical scene telegrams.

Precondition

The scene function must be enabled on the parameter page "Relay outputs... -> VBO... - General -> Enabled functions".

- On the parameter page "Relay outputs... -> VBO... - General -> Scenes" activate the parameter "Delay scene recall".

The delay time is now activated and can be configured separately. The delay only influences the scene recall of the switching output. The delay time is started on arrival of a recall telegram. The corresponding scene will be recalled and the output set to the respective scene position value only after this time has elapsed.

- i** Each scene recall telegram restarts the delay time and retriggers it. If a new scene recall telegram is received while a delay is active (scene recall not yet executed), the old (and not yet recalled scene) will be rejected and only the scene last received executed.
- i** The scene recall delay has no influence on the storage of scene values. A scene storage telegram within a scene recall delay terminates the delay and thus the scene recall.

Presetting the behaviour during ETS programming

When a scene is saved, the scene position values are stored permanently in the device. To prevent the stored values from being replaced during ETS programming of the application or of the parameters by the originally programmed scene position values, the actuator can inhibit overwriting of the scene values. As an alternative, the original values can be reloaded into the device during each programming run of the ETS.

Precondition

The scene function must be enabled on the parameter page "Relay outputs... -> VBO... - General -> Enabled functions".

- On the parameter page "Relay outputs... -> VBO... - General -> Scenes", activate the parameter "Overwrite values stored in the device during the ETS programming operation".

During each ETS programming of the application or of the parameters, the scene position values configured in the ETS for the output concerned will be programmed into the actuator. Scene values stored in the device by means of a storage function will be overwritten, if any.

- Deactivate the parameter "Overwrite values stored in the device during the ETS programming operation".

Scene position values stored in the device with a storage function will be maintained. If no scene values have been stored, the position values last programmed in the ETS remain valid.

- i** When the actuator is commissioned for the first time, this parameter should be activated so that the output is initialised to valid scene position values.

Presetting scene numbers and scene positions

The presetting of the scene number depends on the selected scene configuration. With variable configuration the scene number (1...64) with which the scene is addressed, i.e. recalled or stored, must be determined for each scene of the output. With a fixed scene configuration, the number of a scene is preset invariably. The data point type of the scene extension object permits addressing of up to 64 scenes max.

In addition to specifying the scene number, it must be defined which position is to be set for the output in case of a scene recall. In the "Venetian blind with slat" operating mode, two position values must be defined for the Venetian blind position and slat position.

Precondition

The scene function must be enabled on the parameter page "Relay outputs... -> VBO... - General -> Enabled functions".

- Only with variable scene configuration: On the parameter page "Relay outputs... -> VBO... - General -> Scenes", set the parameter for each scene to the numbers with which the scenes are to be addressed.

A scene can be addressed with the configured scene number. A setting of "0" deactivates the corresponding scene so that neither recalling nor storage is possible.

- Only with fixed scene configuration. On the parameter page "Relay outputs... -> VBO... - General -> Scenes" select or deselect the parameter "Scene active" if necessary.

Only selected scenes can be used. A deselected scene is deactivated and cannot be recalled or stored via the scene extension.

i If with variable scene configuration the same scene number is configured for several scenes, only the scene with the lowest sequential number will be addressed. The other scenes will be ignored in this case.

- On the parameter page "Relay outputs... -> VBO... General -> Scenes" for each scene set the parameters "position of Venetian blind", "position of shutter/awning", "position of venting louver/roof window" and "position of slat" to the desired position value ((0...100%)

During a scene recall, the configured scene position is recalled and set on the output.

i The configured scene positions are then adopted in the actuator during programming with the ETS only if the parameter "Overwrite values stored in the device during ETS download" is activated.

i Before approaching the required scene position, the actuator may perform a reference movement, if the current position data is unknown (e.g. after an ETS programming operation or after switch-on of the bus voltage).

Presetting storage behaviour

The current position value of a Venetian blind, shutter, awning, venting louver and also of a slat can be stored internally via the extension object on reception of a scene storage telegram. The position value can be influenced before storage by all functions of the output (e.g. short-time and long-time operation, central or scene recall telegram, safety and sun protection function and manual control).

Precondition

The scene function must be enabled on the parameter page "Relay outputs... -> VBO... - General -> Enabled functions".

- On the parameter page "Relay outputs... -> VBO... - General -> Scenes" activate the parameter "storage function" for each scene.

The storage function is activated for the scene in question. On reception of a storage telegram via the "Scene extension" object, the current position value will be internally stored.

- Deactivate the parameter "storage function" for each scene.

The storage function is deactivated for the scene in question. A storage telegram received via the "scene extension" object will be rejected.

Optionally, a visual feedback via the output can be signaled when executing a storage command. As feedback, the drive connected to the output moves for the configured travel time of the visual feedback in the opposite direction to the last travel command and then back again. This enables the system operator to determine locally whether the desired scene position has been saved correctly in the actuator.

i The visual feedback is only available in the "Venetian blind with slat" and "shutter/awning" operating modes.

- On the parameter page "Relay outputs... -> VBO... - General -> Scenes" activate the parameter "visual feedback for storage function". Set the duration of the travel movement for the directional travel of the visual feedback for the parameters "Venetian blind travel time" or "shutter/awning travel time".

When a storage function is executed, the visual feedback is activated immediately. The output travels in the opposite direction of the last move command and then back again for the duration of the configured travel time.

- Deactivate the parameter "visual feedback for storage function".

When storing a scene, the visual feedback is not executed. The actuator adopts the current position value of the output without special feedback.

i The visual feedback is only executed if no other function with a higher priority (e.g. safety function) is active in the moment when the memory function is active.

10.9.1 Parameter scene function

Relay output... -> VBO... - General -> Enabled functions

Scene function	Checkbox (yes / no)
This parameter can be used disable or to enable the scene function.	

Relay output... -> VBO... - General: -> Scenes

Delay scene recall	Checkbox (yes / no)
A scene is recalled via the scene extension object. If required, the scene recall can be delayed on reception of a recall telegram (parameter activated). The recall is alternatively made immediately on reception of the telegram (parameter deactivated)	

Delay time minutes (0...59)	0...59
This parameter specifies the length of the scene delay time. Sets the scene delay time in minutes.	

Seconds (0...59)	0...10...59
Sets the scene delay time in seconds.	
The delay time parameters are only visible, if the parameter "Delay scene recall" is activated.	

Visual feedback for storage function	Checkbox (yes / no)
Optionally, a visual feedback via the output can be signaled when executing a storage command. As feedback, the drive connected to the output moves for the configured travel time of the visual feedback in the opposite direction to the last travel command and then back again.	
Parameter activated: When a storage function is executed, the visual feedback is activated immediately. The output travels in the opposite direction of the last move command and then back again for the duration of the configured travel time.	
Parameter deactivated: When storing a scene, the visual feedback is not executed. The actuator adopts the current position value of the output without special feedback.	
This parameter is only available in the "Venetian blind with slat" and "shutter/awning" operating modes.	

Venetian blind travelling time Seconds (1...59)	1...2...59
Setting the travel time for the visual feedback.	
This parameter is only available if the visual feedback is used and the operating mode is set to "Venetian blind with slat".	

Shutter/awning travelling time Seconds (1...59)	1...2...59
<p>Setting the travel time for the visual feedback.</p> <p>This parameter is only available if the visual feedback is used and the operating mode is set to "shutter/awning".</p>	
Overwrite values stored in the device during the ETS programming operation	Checkbox (yes / no)
<p>During storage of a scene, the scene position values are stored internally to memory in the device. To prevent the stored values from being replaced during ETS programming by the originally programmed scene position values, the actuator can inhibit overwriting of the scene values (parameter deactivated). As an alternative, the original values can be reloaded into the device during each programming run of the ETS (parameter activated).</p>	
Scene configuration	variable (1...64 scenes) fixed (64 scenes)
<p>The scene configuration selected here decides whether the number of scenes is either variable (1 ... 64) or alternatively fixed to the maximum (64).</p> <p>variable (1...64 scenes): With this setting, the number of scenes used can be selected anywhere in the range 1 to 64. The parameter "Number of scenes" decides how many scenes are visible for the output in the ETS and can therefore be used. It is possible to specify which scene number (1 ... 64) controls each scene.</p> <p>fixed (64 scenes): With this setting, all scenes are always visible and can therefore be used. The scenes are controlled via permanently assigned scene numbers (1 ... 64) (scene number 1 -> scene 1, scene number 2 -> scene 2 ...). If necessary, individual scenes can be deactivated.</p>	
Number of scenes (1...64)	1...10...64
<p>This parameter is only available with variable scene configuration and defines how many scenes are visible for the output in the ETS and can therefore be used.</p>	
Scene number	0...1*...64 *: The predefined scene number is dependent on the scene (1...64).
<p>With variable scene configuration, the number of scenes used can be selected anywhere in the range 1 to 64. It is then possible to preset which scene number (1 ... 64) controls each scene.</p> <p>A setting of "0" deactivates the corresponding scene so that neither recalling nor storage is possible. If the same scene number is configured for several scenes, only the scene with the lowest sequential number will be addressed. The other scenes will be ignored in this case.</p> <p>This parameter is only available with variable scene configuration.</p>	

Scene active	Checkbox (yes / no)
<p>With a fixed scene configuration, individual scenes can be activated or deactivated. Only activated scenes can be used. A deactivated scene cannot be recalled or stored via the scene extension.</p> <p>This parameter is only available with fixed scene configuration.</p>	
Position of Venetian blind (%)	0*...100 *: The predefined position is dependent on the scene (1...64).
<p>This parameter is used for configuring the position of the Venetian blind, which is set when the scene is recalled.</p> <p>This parameter is only available in the "Venetian blind with slat" operating mode.</p>	
Slat position (%)	0*...100 *: The predefined position is dependent on the scene (1...64).
<p>This parameter is used for configuring the position of the slat, which is set when the scene is recalled.</p> <p>This parameter is only available in the "Venetian blind with slat" operating mode.</p>	
Shutter/awning position (%)	0*...100 *: The predefined position is dependent on the scene (1...64).
<p>This parameter is used for configuring the position of the shutter or awning , which is set when the scene is recalled.</p> <p>This parameter is only available in the "Shutter/awning" operating mode.</p>	
Position of venting louver/roof window (%)	0*...100 *: The predefined position is dependent on the scene (1...64).
<p>This parameter is used for configuring the position of the venting louver or roof window, which is set when the scene is recalled.</p> <p>This parameter is only available in the "venting louver/roof window" operating mode.</p>	
Memory function	Checkbox (yes / no)
<p>If the parameter is activated, the storage function of the scene is enabled. The current position value can then be stored internally via the extension object on receipt of a storage telegram. If the parameter is deactivated, the storage telegrams are rejected.</p>	

10.9.2 Object list scene function

Object no.	Function	Name	Type	DPT	Flag
24, 48...	Scene extension	Venetian blind... - Input	1 bytes	18,001	C, (R), W, -, A
1-byte object for polling or saving a scene.					

10.10 Disabling function and forced position

A disabling function, or alternatively, a forced position function can be configured for each Venetian blind output. In this respect, only one of these functions can be enabled for one Venetian blind output.

Presetting disabling function

During an active disabling function, the KNX control of the output concerned is overridden and locked. The disabling function has the second highest priority after manual control. Therefore, an active disabling function overrides the sun protection function and the direct operation (short-time, long-time telegram, scenes, positioning, central). Permanent locking for service purposes (drive stop) or as lockout protection (raising Venetian blind), for example, can also be overridden.

The deactivation of the disabling function can optionally take place using an additional 1-bit acknowledgement object. This prevents the deactivation of the disabling function by the disabling object.

- On the parameter page "Relay outputs... -> VBO... - General -> Enabled functions" Set the parameter "disabling function / forced position" to "disabling function".

The disabling function is enabled. The communication object "Disable" and the parameters of the disabling function on the parameter page "Relay output... -> VBO... - General -> Disabling function" become visible. The polarity of the disabling object is predefined (1 = output disabled, 0 = output enabled).

- Set the parameter "Beginning of the disabling function" to the required behaviour.

At the beginning of the disabling function (ON telegram to the disabling object), the configured behaviour will be executed and the bus control of the output locked.

no reaction: The relay of the output shows no reaction and remains in the position last set.

stop: At the beginning of the disabling function, the actuator switches the relays of the output to the "stop" position. A travel movement, if any, will be interrupted.

raising / opening: The actuator raises the blind or opens the venting louver/roof window.

lowering / closing: The actuator lowers the blind/shutter or closes the venting louver/roof window.

Approach position: At the beginning of the disabling function, the connected drive can approach a position (0...100 %) specified by further parameters. If Venetian blinds are controlled with the device, the slats can be positioned independently. The actuator performs a reference movement before the position approach, because the current position at the time of the disabling function is unknown.

For disabling function without acknowledgement object...

- Deactivate the parameter "Use acknowledgment".
No additional acknowledgement object is available. The disabling function is deactivated via the disabling object by means of an "OFF" telegram.
- Set the parameter "End of the disabling function" to the required behaviour.
At the end of the disabling function, the configured behaviour will be executed and the bus control of the output enabled again.

no reaction: The relay of the output shows no reaction and remains in the position last set.

stop: At the end of the disabling function, the actuator switches the relays of the output to the "stop" position. A travel movement, if any, will be interrupted.

raising / opening: The actuator raises the blind or opens the venting louver/roof window.

lowering / closing: The actuator lowers the blind/shutter or closes the venting louver/roof window.

Tracking the position: The last switching state received during the disabling function or the last position set before the disabling function (terminated travel movement) will be tracked.

For disabling function with acknowledgement object...

- Activate the parameter "Use acknowledgment"
The acknowledgement object is available. The disabling function can only be deactivated using the acknowledgement object by an ON telegram. OFF telegrams to the disabling object or to the acknowledgement object are ignored by the actuator.
- Set the parameter "End of the disabling function after acknowledgement" to the required behaviour.

After an acknowledgement, the configured behaviour will be executed and the bus operation of the output enabled again.

no reaction: The relay of the output shows no reaction and remains in the position last set.

stop: At the end of the disabling function, the actuator switches the relays of the output to the "stop" position. A travel movement, if any, will be interrupted.

raising / opening: The actuator raises the blind or opens the venting louver/roof window.

lowering / closing: The actuator lowers the blind/shutter or closes the venting louver/roof window.

Tracking the position: The last switching state received during the disabling function or the last position set before the disabling function (terminated travel movement) will be tracked.

- i** After a bus failure or after programming the application or the parameters with the ETS, the disabling function is always deactivated (object value "0").
- i** Updates of the disabling object from "activated" to "deactivated" do not produce a reaction.
- i** The relay of a dimming channel disabled output via the KNX can still be operated manually.

Setting forced position function

The forced position function can be enabled for each output. The forced position has the second highest priority after manual control. It therefore overrides the safety function, the sun protection function and the direct operation (short-time, long-time telegram, scenes, positioning, central). During a forced-position state, the output concerned is locked so that it can no longer be controlled with functions of a lower priority, but only with a manual control. At the end of a manual control, the forced-position action is re-executed if the forced position is still active.

The forced position function possesses a separate 2-bit communication object. The first bit (Bit 0) of the object "Forced position" indicates whether the Venetian blind output is raised or lowered by force. The second bit (bit 1) activates or deactivates the forced-position state (see table below).

The behaviour of a Venetian blind output at the end of the forced-position function can be configured. In addition, the forced object can be initialised on bus voltage return.

Bit 1	Bit 0	Function
0	x	Forced position not active -> normal control
1	0	Forced position active, raising / opening.
1	1	Forced position active: lowering / closing

Table 1: Bit coding of forced position

- i** The forced travel time required by an output to move the drive into the end positions is determined by the parameter "Travel time" on the parameter page "Relay outputs... -> VBO... - General -> Times". Like long time operation, a forced-position movement is derived from the travel time.
Downward movement: movement time + 20 %; Upward movement: movement time + 20 % + configured movement time extension. Forced movements are not retriggerable.
- i** The slats of blinds are not repositioned at the end of forced movements into the end positions.
- i** Updates of the forced position object from "forced position active" to "forced position active" while maintaining the forced movement direction or from "forced position inactive" to "forced position inactive" show no reaction.

- i** After programming of the application or of the parameters with the ETS, the forced position is always cancelled.
- i** The current state of the forced position function will be stored in case of bus voltage failure.
 - On the parameter page "Relay output... -> VBO... - General -> Enabled functions" Set the parameter "disabling function" to "forced position".
The forced position function is enabled. The communication object "forced position" and the parameter of the forced position function on the parameter page "Relay output... -> VBO... - General -> Forced position" become visible.
 - Set the parameter "End of the forced position" to the required behaviour.
At the end of the forced position, the configured behaviour will be executed and the bus control of the Venetian blind output enabled again.

tracking the position: At the end of a forced position function, the output will be set to the state adjusted statically before the forced position function or to the state tracked and internally stored during the forced position function. The position objects, the long-time object and the scene function are tracked.

no change: At the end of forced position function, the state last adjusted will not be changed. Thereafter, the output is again enabled. Any travel movements still in progress at this instant will still be finished.
- i** Parameter setting "Position tracking": The actuator can track absolute positions (position telegram, scene value) during activated forced control only if the position data are known and if positions have been predefined. If this is not the case, no reaction takes place at the time forced control is enabled. Position data can be tracked, if the output has been in a defined position before the forced position function or if a new position telegram has been received via the position objects while the forced position function was interlocked. In the latter case, a reference movement will be executed when the forced position function is enabled, if the position was unknown before or during the safety interlock. Known slat positions will also be tracked as described. This is also the case, when the height of the Venetian blind is unknown. Long time movements (movements without position preset) will, however, always be tracked.
- i** The preset behaviour at the "end of the forced position function" will only be executed, if the output passes over to direct operation at the end of the forced position function. If a safety function or a sun protection function is activated (independent of the preset priority with respect to direct operation), the function with the next lower priority will be executed. The configured behaviour is not executed when the forced position is terminated by a specification on bus voltage return. The preset behaviour "After bus voltage return" will in this case be evaluated.

The forced position communication object can be initialised after bus voltage return. In this way, an output can be influenced and locked on bus initialisation when the forced position function is being activated.

- Set the parameter "After bus voltage return" to the required behaviour.

After bus voltage return, the configured state is transferred to the "Forced position" communication object. When a forced position is activated, the output is immediately activated and interlocked accordingly by forced control after bus voltage return until a forced position is enabled via the KNX. The parameter "After bus voltage return" on the parameter page "Relay output... - VBO... - General" is not evaluated for the affected output in this case.

no forced position active: The forced position is deactivated after bus voltage return. In this case, after bus voltage return the preset behaviour "After bus voltage return" on the parameter page "Relay outputs... - VBO... - General" will be executed.

Forced position function ON, raising or forced position function ON, opening: After bus voltage return, the forced position is activated and the blind raised or the venting louver/roof window opened. The output concerned is interlocked by forced control until an enable signal is received via the KNX. The preset behaviour "After bus voltage return" on the parameter page "Relay outputs... - VBO... - General" is not evaluated for the affected output in this case.

Forced position function ON, lowering or forced position function ON, closing: After bus voltage return, the forced position is activated and the blind closed or the venting louver/roof window closed. The output concerned is interlocked by forced control until an enable signal is received via the KNX. The preset behaviour "After bus voltage return" on the parameter page "Relay outputs... - VBO... - General" is not evaluated for the affected output in this case.

State of the forced position before bus voltage failure: The forced position state last selected and internally stored before bus voltage failure will be tracked after bus voltage return. An ETS programming operation deletes the stored state (reaction in that case same as with "no forced position active"). If the tracked state corresponds to "No forced position active", the behaviour "After bus voltage return" on the parameter page "Relay outputs... - VBO... - General" will be executed.

- i** After programming the application or parameters with the ETS, the forced position function is always deactivated (object value "0").

10.10.1 Parameter disabling function and forced position

Relay outputs... -> VBO... - General -> Enabled functions

Disabling function / Forced position	no selection disabling function forced position
<p>It can be defined here whether a disabling function or a forced position for the Venetian blind output should be available. The disabling function is only configurable as an alternative to the forced position function.</p>	

Relay outputs... -> VBO... - General -> Disabling function

Acknowledgment	Checkbox (yes / no)
<p>The deactivation of the disabling function can optionally take place using an additional 1-bit acknowledgement object. This prevents the deactivation of the disabling function by the disabling object. Alternatively, the acknowledgement object is not available. In this case, disabling is deactivated via the disabling object.</p> <p>Parameter activated: The acknowledgement object is available. The disabling function can only be deactivated using the acknowledgement object by an ON telegram. OFF telegrams to the disabling object are ignored by the actuator.</p> <p>Parameter deactivated: No additional acknowledgement object is available. The disabling function can be deactivated via the disabling object by means of an "OFF" telegram.</p>	

Beginning of the disabling function	no reaction stop raising lowering approaching a position
<p>The behaviour of the output at the beginning of the disabling function can be configured.</p> <p>This parameter is visible only if the disabling function is enabled.</p> <p>no reaction: The relay of the output shows no reaction and remains in the position last set.</p> <p>stop: At the beginning of the disabling function, the actuator switches the relays of the output to the "stop" position. A travel movement, if any, will be interrupted.</p> <p>raising: The actuator raises the blind/shutter.</p> <p>lowering: The actuator lowers the blind/shutter.</p> <p>Approach position: At the beginning of the disabling function, the connected drive can approach a position (0...100 %) specified by further parameters. If Venetian blinds are controlled with the device, the slats can be positioned independently. The actuator performs a reference movement before the position approach, because the current position at the time of the disabling function is unknown.</p> <p>This parameter is only available in the "Venetian blind with slat" and "shutter/awning" operating modes.</p>	

Beginning of the disabling function	no reaction stop open close approaching a position
<p>The behaviour of the output at the beginning of the disabling function can be configured.</p> <p>This parameter is visible only if the disabling function is enabled.</p> <p>no reaction: The relay of the output shows no reaction and remains in the position last set.</p> <p>stop: At the beginning of the disabling function, the actuator switches the relays of the output to the "stop" position. A travel movement, if any, will be interrupted.</p> <p>open: The actuator opens the venting louver/ roof window.</p> <p>close: The actuator closes the venting louver/ roof window.</p> <p>Approach position: At the beginning of the disabling function, the connected drive can approach a position (0...100 %) specified by further parameters. If Venetian blinds are controlled with the device, the slats can be positioned independently. The actuator performs a reference movement before the position approach, because the current position at the time of the disabling function is unknown.</p> <p>This parameter is only available in the "venting louver/roof window" operating mode.</p>	

Position of Venetian blind (0...100%)	0...100
<p>This parameter sets the position value of the Venetian blind to be approached at the beginning of the disabling function.</p> <p>This parameter is only visible if the parameter "beginning of the disabling function" is set to "approach position".</p> <p>This parameter is only visible in the "Venetian blind with slat" operating mode.</p>	
Slat position (0...100%)	0...100
<p>This parameter sets the position value of the slat to be approached at the beginning of the disabling function and, as the case may be, after positioning of the Venetian blind.</p> <p>This parameter is only visible if the parameter "beginning of the disabling function" is set to "approach position".</p> <p>This parameter is only visible in the "Venetian blind with slat" operating mode.</p>	
Shutter/awning position (0...100%)	0...100
<p>This parameter sets the position value of the shutter or awning to be approached at the beginning of the disabling function.</p> <p>This parameter is only visible if the parameter "beginning of the disabling function" is set to "approach position".</p> <p>This parameter is only visible in the shutter/awning operating mode.</p>	
Position of venting louver/roof window (0...100 %)	0...100
<p>This parameter sets the position value of the venting louver or roof window to be approached at the beginning of the disabling function.</p> <p>This parameter is only visible if the parameter "beginning of the disabling function" is set to "approach position".</p> <p>This parameter is only visible in the "venting louver/roof window" operating mode.</p>	

End of the disabling function	no reaction stop raising lowering tracking the position
<p>The behaviour of the output at the end of the disabling function can be configured. This parameter is visible only if the disabling function is enabled and acknowledgment is not used.</p> <p>no reaction: The relay of the output shows no reaction and remains in the position last set.</p> <p>stop: At the end of the disabling function, the actuator switches the relays of the output to the "stop" position. A travel movement, if any, will be interrupted.</p> <p>raising: The actuator raises the blind/shutter.</p> <p>lowering: The actuator lowers the blind/shutter.</p> <p>Tracking the position: The last switching state received during the disabling function or the last position set before the disabling function (terminated travel movement) will be tracked.</p> <p>This parameter is only available in the "Venetian blind with slat" and "shutter/awning" operating modes.</p>	

End of the disabling function	no reaction stop open close tracking the position
<p>The behaviour of the output at the end of the disabling function can be configured. This parameter is visible only if the disabling function is enabled and acknowledgment is not used.</p> <p>no reaction: The relay of the output shows no reaction and remains in the position last set.</p> <p>stop: At the end of the disabling function, the actuator switches the relays of the output to the "stop" position. A travel movement, if any, will be interrupted.</p> <p>open: The actuator opens the venting louver/ roof window.</p> <p>close: The actuator closes the venting louver/ roof window.</p> <p>Tracking the position: The last switching state received during the disabling function or the last position set before the disabling function (terminated travel movement) will be tracked.</p> <p>This parameter is only available in the "venting louver/roof window" operating mode.</p>	

End of the disabling function after acknowledgement	no reaction stop raising lowering tracking the position
<p>The behaviour of the output at the end of the disabling function can be configured. This parameter is visible only if the disabling function is enabled and acknowledgement is used.</p> <p>no reaction: The relay of the output shows no reaction on acknowledgement and remains in the position last set.</p> <p>stop: On acknowledgement, The actuator switches the relays of the output to the "stop" position. A travel movement, if any, will be interrupted.</p> <p>raising: The actuator raises the blind/shutter on acknowledgement.</p> <p>lowering: The actuator lowers the blind/shutter on acknowledgement.</p> <p>Tracking the position: The last switching state received during the disabling function or the last position set on acknowledgement (terminated travel movement) will be tracked.</p> <p>This parameter is only available in the "Venetian blind with slat" and "shutter/awning" operating modes.</p>	

End of the disabling function after acknowledgement	no reaction stop open close tracking the position
<p>The behaviour of the output at the end of the disabling function can be configured. This parameter is visible only if the disabling function is enabled and acknowledgement is used.</p> <p>no reaction: The relay of the output shows no reaction on acknowledgement and remains in the position last set.</p> <p>stop: On acknowledgement, The actuator switches the relays of the output to the "stop" position. A travel movement, if any, will be interrupted.</p> <p>open: The actuator opens the venting louver/ roof window on acknowledgement.</p> <p>close: The actuator closes the venting louver/ roof window on acknowledgement.</p> <p>Tracking the position: The last switching state received during the disabling function or the last position set on acknowledgement (terminated travel movement) will be tracked.</p> <p>This parameter is only available in the "venting louver/roof window" operating mode.</p>	

Relay outputs... -> VBO... - General -> Forced position

End of the forced position	tracking the position no change
<p>At the end of the forced position, the configured behaviour will be executed and the bus control of the Venetian blind output enabled again. This parameter is only visible when the forced position function is enabled.</p> <p>tracking the position: At the end of a forced position function, the output will be set to the state adjusted statically before the forced position function or to the state tracked and internally stored during the forced position function. The position objects, the long-time object and the scene function are tracked.</p> <p>no change: At the end of forced position function, the state last adjusted will not be changed. Thereafter, the output is again enabled. Any travel movements still in progress at this instant will still be finished.</p>	

After bus voltage return	<p>no forced position active</p> <p>Forced position ON, raising</p> <p>Forced position ON, lowering</p> <p>State of forced position before bus voltage failure</p>
<p>After bus voltage return, the configured state is transferred to the "Forced position" communication object. When a forced position is activated, the output is immediately activated and interlocked accordingly by forced control after bus voltage return until a forced position is enabled via the KNX. The parameter "After bus voltage return" on the parameter page "Relay output... - VBO... - General" is not evaluated for the affected output in this case.</p> <p>This parameter is only visible when the forced position function is enabled.</p> <p>no forced position active: The forced position is deactivated after bus voltage return. In this case, after bus voltage return the preset behaviour "After bus voltage return" on the parameter page "Relay outputs... - VBO... - General" will be executed.</p> <p>Forced position ON, raising: After bus voltage return, the forced position is activated and the blind raised. The output concerned is interlocked by forced control until an enable signal is received via the KNX. The preset behaviour "After bus voltage return" on the parameter page "Relay outputs... - VBO... - General" is not evaluated for the affected output in this case.</p> <p>Forced position ON, lowering: After bus voltage return, the forced position is activated and the blind lowered. The output concerned is interlocked by forced control until an enable signal is received via the KNX. The preset behaviour "After bus voltage return" on the parameter page "Relay outputs... - VBO... - General" is not evaluated for the affected output in this case.</p> <p>State of the forced position before bus voltage failure: The forced position state last selected and internally stored before bus voltage failure will be tracked after bus voltage return. An ETS programming operation deletes the stored state (reaction in that case same as with "no forced position active"). If the tracked state corresponds to "No forced position active", the behaviour "After bus voltage return " on the parameter page "Relay outputs... - VBO... - General" will be executed.</p> <p>This parameter is only available in the "Venetian blind with slat" and "shutter/awning" operating modes.</p>	

<p>After bus voltage return</p>	<p>no forced position active Forced position ON, open Forced position ON, close State of forced position before bus voltage failure</p>
<p>After bus voltage return, the configured state is transferred to the "Forced position" communication object. When a forced position is activated, the output is immediately activated and interlocked accordingly by forced control after bus voltage return until a forced position is enabled via the KNX. The parameter "After bus voltage return" on the parameter page "Relay output... - VBO... - General" is not evaluated for the affected output in this case.</p> <p>This parameter is only visible when the forced position function is enabled.</p> <p>no forced position active: The forced position is deactivated after bus voltage return. In this case, after bus voltage return the preset behaviour "After bus voltage return" on the parameter page "Relay outputs... - VBO... - General" will be executed.</p> <p>Forced position function ON, opening. After bus voltage return, the forced position is activated and the venting louver/roof window opened. The output concerned is interlocked by forced control until an enable signal is received via the KNX. The preset behaviour "After bus voltage return" on the parameter page "Relay outputs... - VBO... - General" is not evaluated for the affected output in this case.</p> <p>Forced position function ON, closing. After bus voltage return, the forced position is activated and the venting louver/roof window closed. The output concerned is interlocked by forced control until an enable signal is received via the KNX. The preset behaviour "After bus voltage return" on the parameter page "Relay outputs... - VBO... - General" is not evaluated for the affected output in this case.</p> <p>State of the forced position before bus voltage failure: The forced position state last selected and internally stored before bus voltage failure will be tracked after bus voltage return. An ETS programming operation deletes the stored state (reaction in that case same as with "no forced position active"). If the tracked state corresponds to "No forced position active", the behaviour "After bus voltage return " on the parameter page Relay outputs... - VBO... - General" will be executed.</p> <p>This parameter is only available in the "venting louver/roof window" operating mode.</p>	

10.10.2 Object list disabling function and forced position

Object no.	Function	Name	Type	DPT	Flag
25, 49...	Forced position	Venetian blind... - Input	2-bit	2,001	C, (R), W, -, A

2-bit object for the forced position of a Venetian blind output. The polarity is fixed by the telegram.

Object no.	Function	Name	Type	DPT	Flag
27, 51...	Disabling	Venetian blind... - Input	1-bit	1,003	C, (R), W, -, A

1-bit object for disabling an active Venetian blind output ("1" = disabling function active, "0" = disabling function inactive).

Object no.	Function	Name	Type	DPT	Flag
28, 52...	Disabling acknowledgment	Venetian blind... - Input	1-bit	1,016	C, (R), W, -, A

1-bit object to acknowledge an active disabling function of a Venetian blind output. This object is only visible if the acknowledgement is to be used with the disabling function ("1" = Disabling function is deactivated / "0" = disabling function remains active).

10.11 Supplementary function

Depending on the operating mode set the actuator has up to two supplementary functions per output. In the "Shutter/Awning" operating mode, the supplementary function "lower end position correction/ventilation function" or "Fabric-stretching" can be configured in the ETS as an alternative. In the "Venetian blind with slats" operating mode, only the supplementary function "lower end position correction/ventilation function" can be configured. Only in the "Venting louver/roof window" operating mode can no supplementary function be selected.

Whether an additional function is available, and whichever that may be, is specified by the parameter of the same name on the parameter page "Relay outputs... -> VBO... - General -> Enabled functions".

Fabric stretching

In the "Shutter/awning operating mode, the "Fabric stretching" function can be activated. The Fabric stretching function permits stretching the fabric of an awning tight after lowering.

If activated in the ETS parameters, fabric stretching is executed during each downward movement into any position after stopping and after the configured switchover delay has elapsed. The curtain is then 'stretched' by moving briefly into the opposite travel direction .

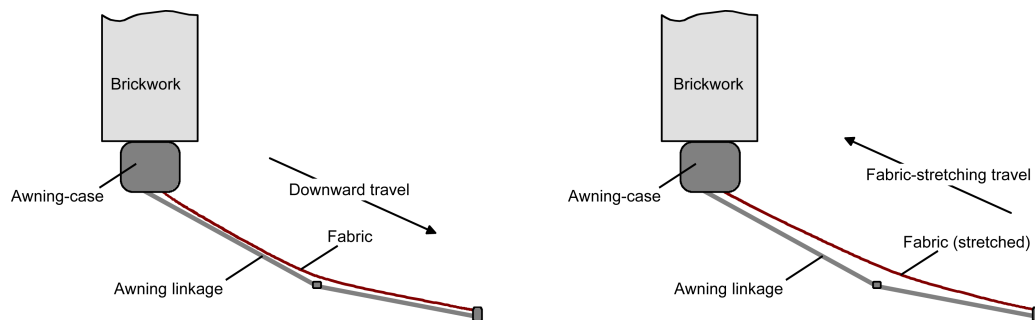

Image 21: Fabric stretching in an awning

The downward travel can be triggered by any of the following events: Long-time, short-time or position telegram, forced position, safety or sun protection function, central telegram or scene recall and also the manual control.

Fabric stretching is never effected in upward movements (retraction of the awning).

- i** Fabric stretching affects the determination of positions and the position feedback since a fabric stretching movement changes the position of a shutter or an awning. After a positioning movement, the position value reported back after the fabric stretching operation will always be a smaller one.
- i** The Fabric stretching function cannot be configured as a supplementary function in the Venetian blind with slat" or "louver/roof window" modes of operation.

Activating the fabric stretching function

The Fabric stretching function can be activated independently for each Venetian blind or shutter on the parameter page

"Relay outputs... -> VBO... - General -> Enabled functions".

The operating mode must be set to "Shutter/awning".

- Set the parameter "Additional function" to "Fabric stretching".

The parameter page

"Relay outputs... -> VBO... - General -> Fabric stretching" is enabled and the Fabric stretching function is activated.

- i** Fabric stretching can only be configured as an alternative to the function "lower end position correction".

Set fabric stretching function

The Fabric stretching function can be activated independently for each shutter or awning output using the parameter "Supplementary function" on the parameter page "Relay outputs... -> VBO... - General -> Enabled functions". If the function is enabled, the parameter page "Relay outputs... -> VBO... - General -> - Fabric stretching" appears in the ETS.

The Fabric stretching function must be enabled.

- Select the desired value for the "Time for fabric stretching" parameter.

After the end of a downward movement, the blind stops and – after the switchover time has elapsed – moves in the opposite direction for a period corresponding to the configured fabric stretching time.

- i** Set the time for fabric stretching to less than the predefined travel time of the shutter or awning. Otherwise, there is the risk of malfunction.
- i** Fabric stretching will only be effected if the downward movement lasts longer than the configured fabric stretching time.

End position correction/ventilation function

In "Venetian blind with slats" and shutter/awning operating modes, the correction for the end position can be activated for the bottom end position (100%). The end position correction allows slat opening on a Venetian blind (e.g. ventilation function) or the opening of the shutter after the blind/shutter has moved downwards to the bottom end position.

The end position correction is activated after stopping at the bottom end position (completion of the extended long-time movement) and after the configured change-over time has elapsed. For correction, the blind/shutter is then moved briefly into the opposite travel direction, positioning the slats or opening the roller blind e.g. for the purpose of ventilation function.

The end position correction/ventilation function can either always be active, or alternatively it can be activated via a separate 1-bit communication object (e.g. controlled by a window contact, application: When the window is closed, the end position correction / ventilation function is executed. With the window already open for ventilation.).

The end position correction/ventilation function is configured differently in the ETS depending on the operating mode. On a Venetian blind a slat position (0...100%) can be configured, which is switched to immediately after the downward movement to the bottom end position through subsequent slat positioning. In contrast, a travel time is set for a shutter. This time defines the length of the downward movement of the roller blind when opening the shutter.

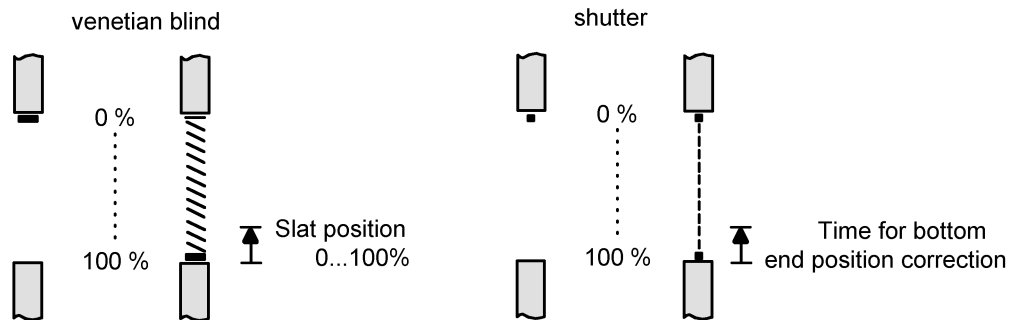

Image 22: End position correction of a Venetian blind or shutter

The trigger of the downward movement to the lower end position for end position correction/ventilation function is either a long-time telegram or a central telegram (downwards). Other functions (short-time or position telegram, disabling function, forced position, safety/sun protection or scene recall as well as manual operation) do not cause end position correction!

End position correction/ventilation function is only carried out if the Venetian blind or shutter was moved to the bottom end position (100 %). In contrast to fabric stretching, the end position correction/ventilation function is not executed for positions deviating from this (0...99%).

- i** End position correction/ventilation function affects the determination of positions and the position feedback since the positioning of the slats or a downward movement changes the position of a Venetian blind or a roller blind. In a positioning movement to the lower end position, the position value reported back after the end position correction will always be a smaller one.
- i** End position correction/ventilation function cannot be configured as an additional function in the venting louver/roof window operating mode.

Activating end position correction/ventilation function

The end position correction/ventilation function can be activated independently for each Venetian blind or shutter/awning output on the parameter page "Relay outputs... -> VBO... - Enabled functions".

The operating mode must be set to "Venetian blind" or "Shutter/awning" mode.

- Set the parameter "supplementary function" to "Lower end position correction/ventilation function".

The parameter page

"Relay outputs... -> VBO... - Bottom end position correction" is enabled and the end position correction/ventilation function is activated.

- i** End position correction/ventilation function cannot be configured as an additional function in the venting louver operating mode.
- i** In the "Shutter/Awning" operating mode, bottom end position correction/ventilation function can only be configured as an alternative to the "Fabric stretching" function.

Setting end position correction/ventilation function

The end position correction/ventilation function can be enabled independently for each Venetian blind or shutter/awning output using the parameter "Additional function" on the parameter page "Relay outputs... "Relay outputs... -> VBO... - Enabled" functions. If the function is enabled, the parameter page "Relay outputs... -> VBO... - General -> Lower end position correction/ventilation function" appears. The end position correction/ventilation function is configured differently in the ETS depending on the operating mode.

The end position correction/ventilation function must be enabled.

- Set the parameter "Lower end position correction/ventilation function" to "always active".

The end position correction/ventilation function is always active. As soon as the blind/shutter has been moved to the lower end position by a long-time command, the actuator executes the correction.
- Set the parameter "Lower end position correction/ventilation function" to "control via object".

The end position correction/ventilation function is active object-controlled. If necessary, it can be enabled by an ON telegram to the "Lower end position correction/ventilation function" object. The actuator only executes the correction if the blind/shutter is moved to the lower end position by a long-time command (drive run completed) and then the enable telegram is received (e.g. opening a window). The enabling of the end position correction / ventilation function is automatically cancelled as soon as the output is controlled again using any other commands. As a result, the correction must be reactivated via another enable telegram if it is to be executed again by direct operation after the next long-time movement to the lower end position. OFF telegrams to the "Lower end position correction/ventilation function" object deactivate the end position correction/ventilation function. The output does not change its blind/shutter position as a result.
- In the "Venetian blind" operating mode: Set the desired slat position value for the end position correction/ventilation function using the "Slat position for end position correction" parameter.

After the end of a downward movement to the bottom end position, the blind/shutter stops and, after the change-over time has elapsed, moves in the opposite direction for a period calculated from the slat position and the configured slat travelling time.

- In the "Roller blind/awning" operating mode: Using the "Time for bottom end position correction", set the desired upwards travel time for the end position correction, for the opening of the shutter.

After the end of a downward movement to the bottom end position, the blind/shutter stops and, after the change-over time has elapsed, moves in the opposite direction for the set period of time.

- i** Set the "Time for bottom end position correction" to less than the predefined travel time of the shutter. Otherwise, there is the risk of malfunction.

10.11.1 Parameter Supplementary functions

Relay outputs... -> VBO... - General -> Enabled functions

Supplementary function	no supplementary function Lower end position correction/Ventilation function fabric stretching
<p>Here, it can be defined, which additional function should be used for the Venetian blind output. Alternatively, the supplementary function can be switched off.</p> <p>The "fabric stretching time" setting can only be selected in the "Shutter/awning" operating mode. This parameter is not available in the "venting louver/roof window" operating mode.</p>	

Relay outputs... -> VBO... - General -> Fabric stretching

Time for fabric stretching Seconds (0...59)	0...1...59
<p>This parameter can be used to specify the time for fabric stretching. After the end of a downward movement, the awning stops and – after the switchover time has elapsed – moves in the opposite direction for a period corresponding to the fabric stretching time configured here.</p> <p>Setting of the seconds of the fabric stretching time.</p>	
Milliseconds (0...900)	0...900
<p>Setting of the milliseconds of the fabric stretching time.</p> <p>The time for fabric stretching must be less than the travel time of the shutter/awning. The parameters regarding the time for the fabric stretching are only available in the operating mode "shutter/awning".</p>	

Relay outputs... -> VBO... - General -> Lower end position correction/ventilation function

Lower end position correction/Ventilation function	always active control via object
<p>The end position correction/ventilation function can either always be active, or alternatively it can be activated via a separate 1-bit communication object (e.g. controlled by a window contact, application: When the window is closed, the end position correction / ventilation function is executed. With the window already open for ventilation.).</p> <p>always active: The end position correction/ventilation function is always active. As soon as the blind/shutter has been moved to the lower end position by a long-time command, the actuator executes the correction.</p> <p>control via object: The end position correction/ventilation function is active object-controlled. If necessary, it can be enabled by an ON telegram to the "Lower end position correction/ventilation function" object. The actuator only executes the correction if the blind/shutter is moved to the lower end position by a long-time command (drive run completed) and then the enable telegram is received (e.g. opening a window). The enabling of the end position correction / ventilation function is automatically cancelled as soon as the output is controlled again using any other commands. As a result, the correction must be reactivated via another enable telegram if it is to be executed again by direct operation after the next long-time movement to the lower end position.</p> <p>OFF telegrams to the "Lower end position correction/ventilation function" object deactivate the end position correction/ventilation function. The output does not change its blind/shutter position as a result.</p> <p>This parameter is only available if the end position correction/ventilation function is enabled.</p>	
Slat position for end position (0...100 %)	0... 50 ...100
<p>The slat position value desired for the end position correction/ventilation function can be set at this point. After the end of a downward movement to the bottom end position, the blind/shutter stops and, after the change-over time has elapsed, moves in the opposite direction for a period calculated from the slat position and the configured slat travelling time.</p> <p>This parameter is only available in the "Venetian blind with slat" operating mode if the end position correction/ventilation function is enabled.</p>	
Time to correct lower end position Seconds (0...59)	0... 1 ...59
<p>The desired upward travelling time to open the roller shutter for the end position correction can be set at this point. After the end of a downward movement to the bottom end position, the blind/shutter stops and, after the change-over time has elapsed, moves in the opposite direction for the set period of time.</p> <p>Seconds setting of the upward travel time of the end position correction/ventilation function.</p>	

Milliseconds (0...900)	0...900
Millisecond setting of the upward travel time of the end position correction/ventilation function.	
The parameters regarding the time of the end position correction/ventilation function are only available if the function is enabled in the "shutter/awning" operating mode.	

10.11.2 Object list supplementary function

Object no.	Function	Name	Type	DPT	Flag
26, 50...	Lower end position correction/ventilation function	Venetian blind... - Input	1-bit	1,003	C, (R), W, -, A
1-bit object for enabling the end position correction/ventilation function after the blind has been moved to the lower end position by a long-time movement of direct operation ("1" = enabling signal issued).					

11 Switching operation

11.1 Priorities

The actuator in switching operation distinguishes between different functions that can have an effect on an output. In order to prevent conflicting states, each available function has a certain priority. The function with the higher priority overrides the function with the lower priority.

For switching operation there are the following priorities...

- 1st priority: manual control (highest priority),
- 2nd priority: Forced position & disabling function,
- 3th priority: Cyclical monitoring,
- 4th priority: Logical operation function & Staircase function,
- 5th priority: direct bus operation ("switching" object, scenes, central functions, reset behaviour)

The behaviour of some functions can be configured at the end (e.g. the behaviour at the end of a manual operation or the behaviour at the end of the disabling function). These predefined reactions are only executed if the actuator can then immediately switch to direct operation (lowest priority).

If another function with a lower priority (e.g. manual operation) has been activated during a function with a high priority (e.g. disabling function), the actuator executes the behaviour at the beginning of the function with the next lower priority (e.g. disabling function). The behaviour at the end of the function with the higher priority (e.g. manual operation) is then not executed!

11.2 General settings

11.2.1 Reset behaviour

Delay after bus voltage return

To reduce telegram traffic on the KNX bus line after bus voltage activation (bus reset), after connection of the device to the bus line or after an ETS programming operation, it is possible to delay all actively transmitted status or feedback telegrams of the switching function. For this purpose, a channel-independent delay can be specified (parameter "Delay after bus voltage return" on the parameter page "General -> General switching outputs"). Only after the configured time elapses are feedback telegrams for initialisation transmitted to the KNX.

Which of the telegrams is actually delayed and which is not can be set for each switching output and for status function separately.

- i** The delay has no effect on the behaviour of the outputs. Only the bus telegrams for status or feedback are delayed. The outputs can also be activated during the delay after bus voltage return.
- i** A setting of "0" for the delay after bus voltage return deactivates the delaying function altogether. In this case, any messages, if actively transmitted, will be transmitted to the KNX without any delay.

11.2.1.1 Reset behaviour parameter

General -> General switching outputs

Delay after bus voltage return Minutes (0...59)	0...59
<p>To reduce telegram traffic on the KNX bus line after bus voltage activation (bus reset), after connection of the device to the KNX line or after an ETS programming operation, it is possible to delay all actively transmitted status or feedback telegrams of the switching function. For this purpose, a delay time can be defined here. Only after the configured time elapses are feedback telegrams for initialisation transmitted to the KNX.</p> <p>Setting the delay time minutes.</p>	
Seconds (0...59)	0...17...59
<p>Setting the delay time seconds.</p>	

11.2.2 Central functions

The actuator offers the possibility of linking selected individual or all switching outputs with up to 6 1-bit communication objects. The behaviour during the control of an output via the central functions can be set to "Switching" or alternatively to "Permanent" (Switching with priority).

Central function = "Switching"

This function is comparable to various central group addresses that are linked to the "Switching" object of a switching output. The last command received (ON or OFF) is executed. The polarity of the central telegram can be configured as inverted if necessary.

Central function = "Permanent":

The assigned switching outputs are controlled according to the parameterised command (ON or OFF) and locked during central control. This means that no other central function with the "Switching" function can control the locked output. Controls via normal switching objects are possible. If an output is assigned to several permanent central functions, the parameterised command decides on the priority of the central function. A "permanent OFF" has a higher priority than a "permanent ON" and thus is preferably executed. Activating a central function "permanent OFF" deactivates other assigned functions for an output with the setting "permanent ON".

Example of permanent central functions

An output is assigned to central function 1 "switching", central function 2 "permanent OFF" and central function 3 "permanent ON". Central functions 2 and 3 are initially deactivated.

When a central telegram = "activate" on central function 3 is received, the assigned switching output switches on. In this state, it can no longer be controlled by central function 1, since a simple "switching" has a lower priority. When a central telegram = "activate" on central function 2 is received, the assigned switching output switches off immediately. Central function 3 is thus deactivated automatically. Only when central functions 2 and 3 are deactivated can the assigned switching output be activated again by central function 1.

- i** After bus voltage return, all central functions are inactive. No central functions are saved in the event of a bus voltage failure.

Disconnect central functions

- Activate the central functions on the parameter page "General -> General switching outputs" with the parameter "Central functions".

The 6 central objects become visible in the ETS. Names can optionally be assigned for the central functions. The names should illustrate the use of the individual central functions (e.g. "All ON", "Central OFF"). The names are only used in the ETS in the text of the central functions and central objects.

Assign switching outputs to the central functions

Each switching output can be assigned to the central functions.

The central functions must be enabled on the parameter page "General -> General switching outputs".

- The parameters "Function and polarity of the central object" on the parameter pages "Relay output ... -> SO... - General" to the desired function.

The appropriate output is assigned to the central function. It can be influenced centrally.

- i** The switching state newly set by the central functions is tracked in the feedback objects and also transmitted to the bus, if these are actively transmitting.

11.2.2.1 Central functions parameter

General -> General switching outputs

Central functions	Checkbox (yes / no)
If the parameter is activated, the 6 central functions of the switching outputs and thus the objects "Switching central function ..." are enabled. An assignment of individual switching outputs to the central functions is only possible if the function is enabled.	

Name of the central functions	Free text
Names can optionally be assigned for the central functions. The names should illustrate the use of the individual central functions (e.g. "All ON", "Central OFF"). The names are only used in the ETS in the text of the central functions and central objects.	

Relay output... -> SO... - General

Central function X assignment (X = 1 ... 6)	Checkbox (yes / no)
These parameters assign the additional functions to the selected switching output. These parameters are only visible when central functions are enabled.	

Function and central object polarity	Switching (1 = ON / 0 = OFF) Switching (0 = ON / 1 = OFF) Permanent ON (1 = active / 0 = inactive) Permanent OFF (1 = active / 0 = inactive)
<p>The function and polarity of the central function is selected here.</p> <p>Switching (1 = ON / 0 = OFF): The last command received (ON or OFF) is executed. The polarity of the central telegram is preset: 1 = ON / 0 = OFF</p> <p>Switching (0 = ON / 1 = OFF): The last command received (ON or OFF) is executed. The polarity of the central telegram is preset: 0 = ON / 1 = OFF</p> <p>Permanent ON (1 = active / 0 = inactive): The assigned switching output is switched on and locked during central control.</p> <p>Permanent OFF (1 = active / 0 = inactive): The assigned switching output is switched off and locked during central control.</p> <p>If an output is assigned to several permanent central functions, the parameterised command decides on the priority of the central function. A "permanent OFF" has a higher priority than a "permanent ON" and thus is preferably executed. With permanent function, the polarity of the central telegram is always fixed: 1 = activate permanent control / 0 = deactivate permanent control.</p> <p>These parameters are only visible when central functions are enabled and assigned.</p>	

11.2.2.2 Object list central functions

Object no.	Function	Name	Type	DPT	Flag
308	Switching	Switching central function 1 - Input	1-bit	1,001	C, (R), W, -, A
309	Switching	Switching central function 2 - Input	1-bit	1,001	C, (R), W, -, A
310	Switching	Switching central function 3 - Input	1-bit	1,001	C, (R), W, -, A
311	Switching	Switching central function 4 - Input	1-bit	1,001	C, (R), W, -, A
312	Switching	Switching central function 5 - Input	1-bit	1,001	C, (R), W, -, A
313	Switching	Switching central function 6 - Input	1-bit	1,001	C, (R), W, -, A

1-bit object for central control of assigned switching outputs.

With central function = "Switching": The polarity of the central telegram can be configured as inverted if necessary.

With central function = "Permanent ON", "Permanent OFF": With permanent function, the polarity of the central telegram is always fixed: 1 = activate permanent control / 0 = deactivate permanent control

11.2.3 Collective feedback

After central commands or after bus voltage return, a KNX line is generally heavily loaded by data traffic as many bus devices are actively transmitting the state of their communication objects by means of feedback telegrams. This effect occurs particularly when using visualisations. Collective feedback for switching states can be used to keep the telegram load low during initialisation.

The collective feedback summarises the switching states of all switching outputs - depending on the device variant - in up to two communication objects. The 32-bit communication objects "Switch 1 ... 16 - collective feedback" (all device variants) and "Switch 17 ... 24 - collective feedback" (variant 12/24-gang only) contain the feedback information of the individual outputs bit-oriented.

The data point type of the collective feedback corresponds to the KNX standard (DPT 27.001). The application would be possible in appropriate visualisation applications - for example in public buildings such as schools or hospitals - where the switching states of the actuators are displayed centrally and no status is displayed at the control sections. In such applications the collective feedback can replace the 1 bit individual feedbacks and thereby significantly reduce the KNX bus load.

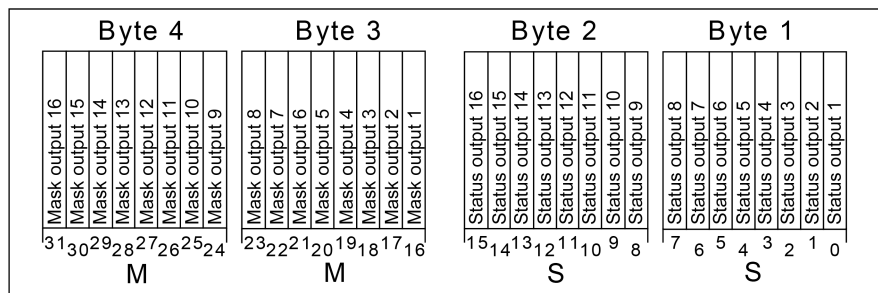

Image 23: Object structure "314" of the collective feedback for the switching outputs 1...16

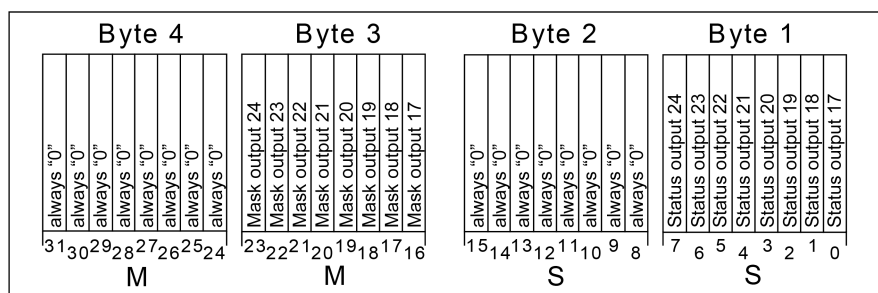

Image 24: Object structure "315" of the collective feedback for the switching outputs 17...24

The collective feedback of the switching operation displays either 16 or 8 different switching states. In so doing, each output possesses a bit, which signals the switching state ("S bit"), and an additional bit, which defines the masking ("M" bit). The "S" bits correspond to the logical non-inverted switching states of the outputs and are either "1" (switched on) or "0" (switched off). The switching state of the relay can be determined from the combination of switching status and configured relay operating

mode (NO or NC contact):

NO contact operating mode: Status = "0" -> Relay open, status = "1" -> Relay closed

NC contact operating mode: Status = "0" -> Relay closed, status = "1" -> Relay open

The "M" bits are "1" when the actuator possesses this output, i.e. the channel configuration plans for this switching output. Similarly, the "M" bits are "0" when the appropriate output is not available on the actuator or the relay is configured as Venetian blind output. In the latter cases, the corresponding "S" bits are continuously "0" because there is no switching status.

i A "flashing" output (see "Disabling function") is always reported as "switched on".

Activate collective feedback and configure the feedback type

The collective feedback can be used as an active message object or as a passive status object. As an active message object, the collective feedback is transmitted to the KNX whenever a switching state changes or is updated (depending on the parameter "Update of the object value"). In the function as a passive status object, there is no automatic telegram transmission. In this case, the object value must be read out. The ETS automatically sets the object communication flags required for proper functioning.

- Activate the parameter "collective feedback" on the parameter page "General -> General switching outputs".
Collective feedback is enabled. The communication object and others parameters become visible.
- Set the parameter "Type of feedback" to "Active signalling object".
The collective feedback is transmitted once the status is updated. An automatic telegram transmission of the feedback takes place after bus voltage return or after programming with the ETS.
- Set the parameter to "Passive status object".
The collective feedback will be transmitted in response only if the feedback object is read out from by the KNX. No automatic telegram transmission of the feedback takes place after bus voltage return or after programming with the ETS.

Setting the update of collective feedback

In the ETS, you can specify when the actuator should update the feedback value for the collective feedback in case of an actively transmitting communication object. The object value updated by the actuator is then signalled actively to the KNX.

Precondition:

Collective feedback must be enabled. In addition, the feedback must be configured to actively transmitting.

- Set the parameter "Update of the object value" to "On each update object 'Switching'/'Central'".

The actuator updates the feedback value in the object once a new telegram is received on the input objects "Switching" or "Switching central function..." or the switching state changes internally (e.g. through a time function). A new telegram is also then actively transmitted to the KNX each time. The telegram value of the feedback does not necessarily have to change in the process. Hence, corresponding collective feedback is also generated on a switching object such as in the case of cyclical telegrams, for example.

- Set the parameter to "Only if the feedback value changes".

The actuator only updates the feedback value in the object if the telegram value (e.g. "OFF" to "ON") also changes or the switching state changes internally (e.g. through a time function). If the telegram value of the feedback does not change (e.g. in the case of cyclical telegrams to the "Switching" object with the same telegram value), the actuator does not transmit any feedback. Consequently, with an actively transmitting feedback object, no telegram with the same content will be transmitted repeatedly either.

Activating collective feedback on return of bus voltage or after programming with the ETS

If used as active message object, the collective feedback is transmitted to the KNX after bus voltage return or after programming with the ETS. In these cases, the feedback can be time-delayed with the time delay being set globally.

Precondition:

Collective feedback must be enabled. In addition, the feedback must be configured to actively transmitting.

- Activate the parameter "Delay after bus voltage return" of the collective feedback"

The collective feedback telegram is transmitted with a delay after bus voltage return or ETS programming. No feedback telegram is transmitted during a running delay, even if a switching state changes during the delay.

- Deactivate the parameter "Delay after bus voltage return" of the collective feedback"

The collective feedback telegram is transmitted immediately after bus voltage return or ETS programming.

Setting cyclic transmission of the collective feedback

The telegram of the collective feedback can also be transmitted cyclically, in addition to transmission on a change or update.

Precondition:

Collective feedback must be enabled. In addition, the feedback must be configured to actively transmitting.

- Activate the parameter "cyclical transmission". Configure the cycle time for the parameter "Time for cyclical transmission".

Cyclical transmission is activated. The collective feedback is transmitted to the KNX cyclically and if one of the switching states changes or is updated.

- Deactivate the parameter "Cyclical transmission".

Cyclical transmission is deactivated, which means that the collective feedback is only transmitted to the KNX if one of the switching states changes or is updated.

- i** During an active delay after bus voltage return, no collective feedback will be transmitted even if a switching state changes.

11.2.3.1 Parameter collective feedback

General -> General switching outputs

Collective feedback	Checkbox (yes / no)
The collective feedback can be enabled here.	
Type of feedback	active signalling object passive status object
<p>Collective feedback can take place in the form of active message objects or passive status objects. In the case of active message objects, the feedback is automatically transmitted to the bus whenever the status contained therein is updated. In the function as a passive status object, there is no automatic telegram transmission. In this case, the object values must be read out. The ETS automatically sets the communication flags of the objects required for proper functioning.</p> <p>This parameter is visible only if collective feedback is enabled.</p>	
Updating of the object value	after each update object "Switching"/"Central" only if the feedback value changes
<p>Here, you can specify when the actuator should update the feedback values for the collective feedback in case of an actively transmitting communication object. The object value updated by the actuator is then signalled actively to the KNX.</p> <p>This parameter is only visible in case of an actively transmitting feedback object.</p> <p>after each update object "Switching"/"Central": The actuator updates the feedback value in the object once a new telegram is received on the input objects "Switching" or "Switching central function" or the switching state changes internally (e.g. through a time function). A new telegram is also then actively transmitted to the KNX each time. The telegram value of the feedback does not necessarily have to change in the process. Hence, corresponding collective feedback is also generated on a switching object such as in the case of cyclical telegrams, for example.</p> <p>only if the feedback value changes: The actuator only updates the feedback value in the object if the telegram value (e.g. "OFF" to "ON") also changes or the switching state changes internally (e.g. through a time function). If the telegram value of the feedback does not change (e.g. in the case of cyclical telegrams to the "Switching" object with the same telegram value), the actuator does not transmit any feedback. Consequently, with an actively transmitting feedback object, no telegram with the same content will be transmitted repeatedly either.</p>	
Delay after bus voltage return	Checkbox (yes / no)
<p>If used as active message object, the collective feedback states are transmitted to the KNX after bus voltage return or after an ETS programming operation. In these cases, the feedback can be time-delayed with the time delay being set globally on the "General -> General switching outputs" parameter page.</p> <p>This parameter is only visible in case of an actively transmitting feedback object.</p>	

Cyclical transmission	Checkbox (yes / no)
<p>The objects of the collective feedback can also transmit their value cyclically in addition to transmission when updating. If the parameter is activated, cyclical transmission is performed.</p> <p>If the parameter is deactivated, the cyclical transmission is inactive, which means that collective feedback is only transmitted to the KNX if one of the contained states changes.</p> <p>This parameter is only visible in case of an actively transmitting feedback object.</p>	
Cycle time hours (0...23)	0...23
<p>The cycle time for the cyclical transmission of the collective feedback is configured here.</p> <p>Setting the cycle time hours.</p>	
Minutes (1...59)	1...2...59
<p>Setting the cycle time minutes.</p>	
Seconds (1...59)	0...59
<p>Setting the cycle time minutes.</p> <p>Smallest adjustable cycle time = 10 seconds.</p>	

11.2.3.2 Object list collective feedback

Object no.	Function	Name	Type	DPT	Flag
314	Feedback switching status	Switching 1...16 - collective Feedback - Output	4 bytes	27,001	C, R, -, T, A
<p>4-byte object for the collected status feedback of the states for switching outputs 1...16. The collective feedback summarises the switching status in just one telegram. The object contains bit-orientated feedback information. The object can be actively transmitting or passively read out (parameter-dependent).</p>					
Object no.	Function	Name	Type	DPT	Flag
315	Feedback switching status	Switching 17...24 - collective Feedback - Output	4 bytes	27,001	C, R, -, T, A
<p>4-byte object for the collected status feedback of the states for switching outputs 17...27. The collective feedback summarises the switching status in just one telegram. The object contains bit-orientated feedback information. The object can be actively transmitting or passively read out (parameter-dependent). This object is only available in device variant "24/12-gang"!</p>					

11.2.4 Name of a switching output

Here, you can optionally assign a name for each switching output. The name is intended to illustrate the use of the output (e.g. "light kitchen", "wall lamp living room"). The names are only used in the ETS in the text of the parameter pages and communication objects.

11.2.4.1 Parameter name

Relay outputs... -> SO... - General

Name of switching output	Free text
The text entered in this parameter is applied to the name of the communication objects and is used to label the switching output in the ETS parameter window (e.g. "light kitchen", "wall lamp living room"). The text is not programmed in the device.	

11.3 Operating mode

The relay of a switching output can be configured as NO or NC contacts. In this way, the inversion of switching states is possible.

The parameter "Operating mode" exists separately for each switching output on the parameter page "Relay output... -> SO... - General".

- Set the operating mode to "NO contact".
The relay works as an NO contact. The logical switching state of the switching output is not forwarded to the relay in inverted form.
Switching state = OFF ("0") -> relay contact open,
Switching state = ON ("1") -> relay contact closed.
- Set the operating mode to "NC contact".
The relay works as an NC contact. The logical switching state of the switching output is forwarded to the relay in inverted form.
Switching state = OFF ("0") -> relay contact closed,
Switching state = ON ("1") -> relay contact open.
- i** The logic switching state "ON" or "OFF" is set by the communication object "Switching" and influenced by the functions that can be optionally activated (e.g. timing/staircase functions, logic operations, disabling/forced-control position functions, scenes, central objects).
- i** The 1-bit feedbacks always feed back the logical switching state of the switching outputs. Depending on the configured relay operating mode and an inverted or non-inverted evaluation, a status feedback has the following meanings:
NO contact not inverted: Feedback = "ON" -> Relay closed, feedback = "OFF" -> Relay opened
NO contact inverted: Feedback = "ON" -> Relay opened, feedback = "OFF" -> Relay closed
NC contact not inverted: Feedback = "ON" -> Relay opened, feedback = "OFF" -> Relay closed
NC contact inverted: Feedback = "ON" -> Relay closed, feedback = "OFF" -> Relay opened
- i** Feedback of the current switching status via the "switching" object is not possible.

11.3.1 Operating mode parameter

Relay output... -> SO... - General

Operating mode	NO contact NC contact
<p>The relay of a switching output can be configured as NO or NC contacts. In this way, the inversion of switching states is possible.</p> <p>NO contact: Switching state = OFF ("0") -> Relay contact opened Switching state = ON ("1") -> Relay contact closed</p> <p>NC contact: Switching state = OFF ("0") -> Relay contact closed Switching state = ON ("1") -> Relay contact opened</p>	

11.3.2 Object list operating mode

Object no.	Function	Name	Type	DPT	Flag
322, 342...	Switching	Switching... - Input	1-bit	1,001	C, (R), W, -, A
<p>1-bit input object to activate a switching output ("1" = Switch on / "0" = Switch off; "NO contact" or "NC contact" operating mode can be configured).</p>					

11.4 Reset and initialisation behaviour

The switching states of the switching outputs in the event of a bus voltage failure, after bus voltage return or an ETS programming operation can be set separately.

Presetting the behaviour after ETS programming

The parameter "After ETS programming operation" exists separately for each switching output on the parameter page "Relay output... -> SO... - General". This parameter can be used to configure the switching state of a switching output, irrespective of the behaviour after bus voltage return.

- Set the parameter to "no reaction".
After ETS programming, the relay of the output shows no response and remains in the switching state last selected. The internal logical switching state is not lost by the ETS programming operation.
 - Set the parameter to "Open contact".
The relay contact opens after an ETS programming operation
 - Set the parameter to "Close contact".
The relay contact closes after an ETS programming operation
 - Set the parameter to "as with bus voltage return".
After an ETS programming operation, the switching output will behave in the manner defined in the parameter "After bus voltage return". If the behaviour there is configured to "state as before bus voltage failure", then that switching state is also set after an ETS programming operation which was active at the time of the last bus voltage failure. An ETS programming operation does not overwrite the saved switching state.
- i** The configured behaviour will be executed after every application or parameter download by the ETS. A simple download of the physical address alone or partial programming of only the group addresses has the effect that this parameter is disregarded and that the configured "After after bus voltage return" will be executed instead.
- i** A switching state set after an ETS programming operation is added to the feedback object. Actively transmitting feedback objects also only first transmit after an ETS programming cycle when the initialisation has finished and, if necessary, the "delay after bus voltage return" has elapsed.
- i** After an ETS programming operation, the disabling functions and the forced-positions are always deactivated. The states of the forced position objects saved in case of the bus voltage failure are deleted.

Setting the behaviour in case of bus voltage failure

The parameter "In case of bus voltage failure" is available separately for each switching output on the parameter page "Relay output.... -> SO... - General".

- Set the parameter to "no reaction".

In case of bus voltage failure, the relay of the output shows no reaction and remains in the switching state last selected.

- Set the parameter to "Open contact".
The relay contact opens in case of bus voltage failure.
- Set the parameter to "Close contact".
The relay contact closes in case of bus voltage failure.

- i** Active disabling functions or forced position functions are cancelled and remain inactive until they are reactivated after a bus voltage return.
- i** In case of a bus voltage failure, the current states of the forced-positions are also saved so that they can be tracked on return of bus voltage if necessary (depending on the parameterization of the forced positions).
- i** In case of a bus voltage failure, the current switching states of all switching outputs are saved internally, so that these states can be reset after bus voltage return, if this is configured in the ETS.

Setting the behaviour after bus voltage return

The parameter "After bus voltage return" exists separately for each switching output on the parameter page "Relay output.... -> SO... - General".

- Set the parameter to "no reaction".
After bus voltage return, the relay of the output shows no reaction and remains in the switching state last selected.
- Set the parameter to "Open contact".
The relay contact is opened.
- Set the parameter to "Close contact".
The relay contact is closed.
- Set the parameter to "state as before bus voltage failure".
After bus voltage return, the switching state last set and internally stored before bus failure will be tracked.
- Preset parameter to "Activate staircase function". This setting is only available when the staircase function of the appropriate switching output is enabled.
The staircase function is – irrespective of the "Switching" object - activated after bus voltage return.

- i** Setting "state as before bus voltage failure": An ETS programming operation of the application or the parameter resets the stored switching state to "OFF".
- i** A switching state set after bus voltage return is tracked in the feedback objects. Actively transmitting feedback objects first transmit, however, after bus voltage return, when the initialisation of the actuator has finished, and if necessary the "Delay after bus voltage return" has elapsed.

- i** In the case of forced position as supplementary function: The communication object of the forced position can be initialised separately after bus voltage return. This has an effect on the reaction of the switching output when the forced position is activated on bus voltage return. The configured "Behaviour after bus voltage return" is only executed when no forced position after a bus voltage return is activated!
- i** In the case of enabling function as supplementary function: Active disabling functions are always inactive after bus voltage return.

11.4.1 Reset and initialisation behaviour parameter

Relay output... -> SO... - General

After ETS programming operation	close contact open contact no reaction as with bus voltage return
<p>The actuator permits setting of the reaction separately for each switching output after an ETS programming operation.</p> <p>Close contact: The relay contact closes after an ETS programming operation</p> <p>Open contact: The relay contact opens after an ETS programming operation</p> <p>no reaction: After ETS programming, the relay of the output shows no response and remains in the switching state last selected. The internal logical switching state is not lost by the ETS programming operation.</p> <p>as with bus voltage return: After an ETS programming operation, the switching output will behave in the manner defined in the parameter "After bus voltage return". If the behaviour there is configured to "state as before bus voltage failure", then that switching state is also set after an ETS programming operation which was active at the time of the last bus voltage failure. An ETS programming operation does not overwrite the saved switching state.</p>	
In case of bus voltage failure	close contact open contact no reaction
<p>The actuator permits setting of the reaction separately for each switching output if there is a bus voltage failure.</p> <p>Close contact: The relay contact closes in case of bus voltage failure.</p> <p>Open contact: The relay contact opens in case of bus voltage failure.</p> <p>no reaction: In case of bus voltage failure, the relay of the output shows no reaction and remains in the switching state last selected.</p>	

After bus voltage return	close contact open contact state as before bus voltage failure no reaction activating staircase function
<p>The actuator allows the reaction to be set separately for each switching output after bus voltage return.</p> <p>Close contact: The relay contact is closed.</p> <p>Open contact: The relay contact is opened.</p> <p>State as before bus voltage failure: After bus voltage return, the switching state last set and internally stored before bus failure will be tracked.</p> <p>no reaction: After bus voltage return, the relay of the output shows no reaction and remains in the switching state last selected.</p> <p>Activate staircase function: The staircase function is – irrespective of the "Switching" object - activated after bus voltage return. This setting is only available when the staircase function is enabled.</p>	

11.5 Cyclical monitoring

The actuator offers the option of monitoring individual switching outputs cyclically for the arrival of switching telegrams. In this way, the objects which must be updated cyclically by the KNX can be monitored. In so doing, the polarity of the telegram update ("OFF" or "ON") is insignificant.

If there is no update of the monitored objects within a specifically configured monitoring time, then the affected switching outputs set themselves to the preferred pre-defined contact position. However, this does not disable the outputs, so that, after the reception of a further switching telegram, the new switching state is set at the output.

The monitoring time can be defined separately for each switching output on the parameter page "Relay output... -> SO... - General" by the parameter "cycle time". The time is restarted for a switching output after each reception of a switching telegram via the objects "Switching" or "Central switching" (if at least one central function is assigned to the affected switching output). The monitoring time is also restarted automatically after bus voltage return or after an ETS programming operation.

Activate cyclical monitoring

The cyclical monitoring function can be activated separately for each switching output by the parameter "Cyclical monitoring" on the parameter page "Relay output... -> SO... - General". If the function is activated, as soon as the monitoring time elapses without having received a telegram update, the actuator sets the preference period for the appropriate switching output after the time has elapsed.

- Set the parameter to "no".
Cyclical monitoring is deactivated.
 - Set the parameter to "Yes, 'ON' when time has elapsed".
Cyclical monitoring is activated. After the time has elapsed, the switching output is switched on. The cycle time can be configured.
 - Set the parameter to "Yes, 'OFF' when time has elapsed".
Cyclical monitoring is activated. After the time has elapsed, the switching output is switched off. The cycle time can be configured.
- i** If cyclical monitoring is activated, the following functions cannot be configured: Time delays, staircase function, logic operation and scene.
- i** The disabling and forced position function has a higher priority than the cyclical monitoring.

11.5.1 Parameter for cyclical monitoring

Relay output... -> SO... - General

Cyclical monitoring	no yes, "ON" when time has elapsed yes, "OFF" when time has elapsed
<p>The actuator offers the option of monitoring individual switching outputs cyclically for the arrival of switching telegrams. In this way, the objects which must be updated cyclically by the KNX can be monitored. In so doing, the polarity of the telegram update ("OFF" or "ON") is insignificant. If there is no update of the monitored objects within a specifically configured monitoring time, then the affected switching outputs set themselves to the preferred predefined contact position. However, this does not disable the outputs, so that, after the reception of a further switching telegram, the new switching state is set at the output.</p> <p>no: Cyclical monitoring is deactivated.</p> <p>yes, 'ON' when time has elapsed: Cyclical monitoring is activated.. After the time has elapsed, the switching output is switched on.</p> <p>yes, 'OFF' when time has elapsed: Cyclical monitoring is activated.. After the time has elapsed, the switching output is switched off.</p>	
Cycle time hours (0...23)	0...23
<p>The monitoring time for cyclical monitoring is set here. Sets the monitoring time hours. This parameter is only visible if cyclical monitoring is enabled.</p>	
Minutes (0...59)	0...2...59
<p>Sets the monitoring time minutes. This parameter is only visible if cyclical monitoring is enabled.</p>	
Seconds (0...59)	0...59
<p>Sets the monitoring time seconds. This parameter is only visible if cyclical monitoring is enabled.</p>	

11.6 Feedback switching status

The actuator can track the current switching state of a switching output via a feedback object and can also transmit them to the KNX. On each switching operation, the actuator determines the object value of the feedback. The actuator tracks the switching state and updates the feedback object even when a switching output, for example, is activated by a supplementary function or scene function.

The switching status feedback object is updated after the following events...

- Immediately after switch-on of a switching output (if necessary, first after a switch-on delay has elapsed / also after a staircase function).
- After switch-off of a switching output (if necessary, only after a switch-off delay has elapsed / also after a staircase function).
- During updating of the switching state from "ON" to "ON" or "OFF" to "OFF" when the switching output is already switched on or off. However, only if the parameter "Update of the object value" is configured to "On each update of object 'Switching'/'Central'".
- At the start or end of a disabling or forced position function, if a state changes as a result.
- Always on bus voltage return or at the end of any ETS programming process (if necessary, also delayed).

i In the case of enabling function as supplementary function: A "flashing" switching channel is always reported as "switched on".

Activate switching status feedback

The switching status feedback can be used as an active message object or as a passive status object. As an active message object, the switching status feedback information is also directly transmitted to the KNX whenever the feedback value is updated. As a passive status object, there is no telegram transmission after an update. In this case, the object value must be read out. The ETS automatically sets the object communication flags required for proper functioning.

Optionally, the actuator can also feed back the status of an independent switching output in inverted form.

The parameter "switching status" exists separately for each switching output on the parameter page "Relay output... -> SO... - General -> Feedback telegrams". Feedback takes place via the "Switching feedback" object.

Precondition:

The feedbacks must be enabled on the parameter page "Relay output... -> SO... - General -> Enabled" functions.

- Set the parameter to "no inversion, active signalling object".
A switching status is transmitted as soon as it is updated. An automatic telegram transmission of the feedback takes place after bus voltage return or after programming with the ETS. The switching status is written to the object in non-inverted form.
- Set the parameter to "no inversion, active signalling object".

A switching status will be transmitted in response only if the feedback object is read out from by the KNX. No automatic telegram transmission of the feedback takes place after bus voltage return or after programming with the ETS. The switching status is written to the object in non-inverted form.

- Set the parameter to "Invert, active signalling object".

A switching status is transmitted as soon as it is updated. An automatic telegram transmission of the feedback takes place after bus voltage return or after programming with the ETS. The switching status is written to the object in inverted form.

- Set the parameter to "Invert, passive status object".

A switching status will be transmitted in response only if the feedback object is read out from by the KNX. No automatic telegram transmission of the feedback takes place after bus voltage return or after programming with the ETS. The switching status is written to the object in inverted form.

- Set the parameter to "no reaction".

The switching status feedback of the affected switching output is deactivated.

- i** Depending on the configured relay operating mode and an inverted or non-inverted evaluation, a status feedback has the following meanings:
- NO contact not inverted: Feedback = "ON" -> Relay closed, feedback = "OFF" -> Relay opened
- NO contact inverted: Feedback = "ON" -> Relay opened, feedback = "OFF" -> Relay closed
- NC contact not inverted: Feedback = "ON" -> Relay opened, feedback = "OFF" -> Relay closed
- NC contact inverted: Feedback = "ON" -> Relay closed, feedback = "OFF" -> Relay opened

- i** Feedback of the current switching status via the "switching" object is not possible.

Set update of "Switching feedback"

In the ETS, you can specify when the actuator should update the feedback value for the switching status (object "Switching feedback") in case of an actively transmitting communication object. The object value updated by the actuator is then signalled actively to the KNX.

The parameter "Update of the object value" can be preset separately for each switching output on the parameter page "Relay output... -> SO... - General -> Feedback telegrams".

Precondition:

The feedbacks must be enabled on the parameter page "Relay output... -> SO... - General -> Enabled" functions. In addition, the switching status feedback must be configured to actively transmitting.

- Set the parameter to "after each update object 'Switching'/'Central'".

The actuator updates the feedback value in the object once a new telegram is received on the input objects "Switching" or "Central switching" or the switching state changes internally (e.g. through a time function). With an actively transmitting feedback object, a new telegram is also then actively transmitted to the KNX each time. The telegram value of the feedback does not necessarily have to change in the process. Hence, a corresponding switching status feedback is also generated on the "Switching" object such as in the case of cyclical telegrams for example.

- Set the parameter to "Only if the feedback value changes".

The actuator only updates the feedback value in the object if the telegram value (e.g. "OFF" to "ON") also changes or the switching state changes internally (e.g. through a time function). If the telegram value of the feedback does not change (e.g. in the case of cyclical telegrams to the "Switching" object with the same telegram value), the actuator does not transmit any feedback. Consequently, with an actively transmitting feedback object, no telegram with the same content will be transmitted repeatedly either.

This setting is recommendable, for instance, if the "Switching" and "Switching feedback" objects are linked to an identical group address. This is often the case when activating by means of light scene push-button sensors (recall and storage function).

Setting switching status feedback on bus voltage return or after programming with the ETS

If used as active message object, the switching status feedback states are transmitted to the KNX after bus voltage return or after programming with the ETS. In these cases, the feedback telegram can be time-delayed, with the delay being preset globally for all switching outputs together.

- Activate the parameter "Delay after bus voltage return" on the parameter page "Relay output... -> SO... - General ->Feedback telegrams".

The switching status telegram is transmitted with a delay after bus voltage return or after an ETS programming operation. No feedback telegram is transmitted during a running delay, even if the switching state changes during this delay.

- Deactivate the parameter.

The switching status telegram is transmitted immediately after bus voltage return or after an ETS programming operation.

Setting cyclical transmission of the switching status feedback telegram

The switching status feedback telegrams can, if active, also be transmitted cyclically, in addition to the transmission after updating.

- Activate the parameter "cyclical transmission" on the parameter page "Relay output... -> SO... - General ->Feedback telegrams".

Cyclical transmission is activated. The cycle time for the switching status feedback can be configured separately for the parameter "Time for cyclical transmission".

- Deactivate the parameter.

Cyclical transmission is deactivated so that the feedback is transmitted to the KNX only when updated by the actuator.

11.6.1 Parameter feedback switching status

Relay output... -> SO... - General -> Enabled functions

Feedback telegrams	Checkbox (yes / no)
This parameter can be used to disable or to enable the feedback functions.	

Relay output... -> SO... - General -> Feedback telegrams

switching status	no feedback no inversion, active signalling object no inversion, passive status object inversion, active signalling object inversion, passive status object
<p>The current switching state of the switching output can be reported separately back to the KNX.</p> <p>no feedback: The switching status feedback of the affected switching channel is deactivated.</p> <p>no inversion, active signalling object: A switching status is transmitted as soon as it is updated. An automatic telegram transmission of the feedback takes place after bus voltage return or after programming with the ETS. The switching status is written to the object in non-inverted form.</p> <p>no inversion, passive status object: A switching status will be transmitted in response only if the feedback object is read out from by the KNX. No automatic telegram transmission of the feedback takes place after bus voltage return or after programming with the ETS. The switching status is written to the object in non-inverted form.</p> <p>inversion, active signalling object: A switching status is transmitted as soon as it is updated. An automatic telegram transmission of the feedback takes place after bus voltage return or after programming with the ETS. The switching status is written to the object in inverted form.</p> <p>inversion, passive status object: A switching status will be transmitted in response only if the feedback object is read out from by the bus. No automatic telegram transmission of the feedback takes place after bus voltage return or after programming with the ETS. The switching status is written to the object in inverted form.</p>	

Updating of the object value	after each update object "Switching"/"Central" only if the feedback value changes
<p>Here, you can specify when the actuator should update the feedback value for the switching status (object "Switching feedback") in case of an actively transmitting communication object. The object value updated by the actuator is then signalled actively to the KNX.</p> <p>This parameter is only visible in case of an actively transmitting feedback.</p> <p>after each update object "Switching"/"Central": The actuator updates the feedback value in the object once a new telegram is received on the input objects "Switching" or "Central switching" or the switching state changes internally (e.g. through a time function). With an actively transmitting feedback object, a new telegram is also then actively transmitted to the KNX each time. The telegram value of the feedback does not necessarily have to change in the process. Hence, a corresponding switching status feedback is also generated on the "Switching" object such as in the case of cyclical telegrams for example.</p> <p>only if the feedback value changes: The actuator only updates the feedback value in the object if the telegram value (e.g. "OFF" to "ON") also changes or the switching state changes internally (e.g. through a time function). If the telegram value of the feedback does not change (e.g. in the case of cyclical telegrams to the "Switching" object with the same telegram value), the actuator does not transmit any feedback. Consequently, with an actively transmitting feedback object, no telegram with the same content will be transmitted repeatedly either.</p>	
Delay after bus voltage return	Checkbox (yes / no)
<p>The states of the switching status feedback can be transmitted to the KNX with a delay after bus voltage return or after an ETS programming operation. The activated parameter causes a delay on bus voltage return. The delay time is configured for all outputs on the parameter page "General -> General switching outputs".</p> <p>This parameter is only visible in case of an actively transmitting feedback.</p>	
Cyclical transmission	Checkbox (yes / no)
<p>The switching status feedback telegrams can, if actively transmitting, also be transmitted cyclically, in addition to the transmission after updating.</p> <p>This parameter is only visible in case of an actively transmitting feedback.</p> <p>Parameter activated: Cyclical transmission is activated.</p> <p>Parameter deactivated: Cyclical transmission is deactivated so that the feedback is transmitted to the KNX only when updated by the actuator.</p>	
Time for cyclical transmission hours (0...23)	0...23
<p>This parameter defines the time for the cyclical transmission of the switching status feedback.</p> <p>Setting the cycle time hours. This parameter is only available if cyclical transmission is activated.</p>	

Minutes (0...59)	0...2...59
Setting the cycle time minutes. This parameter is only available if cyclical transmission is activated.	
Seconds (0...59)	0...59
Setting the cycle time seconds. This parameter is only available if cyclical transmission is activated.	

11.6.2 Object list feedback switching status

Object no.	Function	Name	Type	DPT	Flag
323, 343...	Switching feedback	Switching... - Output	1-bit	1,001	C, R, -, T, A
<p>1-bit object for feedback signalling of a switching state of a switching output ("1" = on / "0" = off) to the bus.</p> <p>Depending on the configured relay operating mode, the feedback value should be interpreted differently:</p> <p>NO contact operating mode: Feedback = "0" -> Relay open, feedback = "1" -> Relay closed</p> <p>NC contact operating mode: Feedback = "0" -> Relay closed, feedback = "1" -> Relay opened</p>					

11.7 Time delays

Up to two time functions can be preset for each switching output, independently of each other. The time functions affect the communication objects "Switching" or "Central switching" only (if at least one of the central functions is activated for the output concerned) and delay the object value received depending on the telegram polarity.

- i** At the end of a disabling function or forced position function, the switching state received during the function or set before the function can be tracked. Residual times of time functions are also tracked if these had not yet fully elapsed at the time of the reactivation or forced control.
- i** The time delays do not influence the staircase function if this is enabled.
- i** A time delay still in progress will be fully aborted by a reset of the actuator (bus voltage failure or ETS programming).

Activating switch-on delay

The switch-on delay can be activated separately in the ETS for each switching output.

Precondition:

The time delays must be enabled on the parameter page "Relay output... -> SO... - General -> Enabled" functions.

- Set the parameter "Selection of time delay" to "Switch-on delay" or to "Switch-on delay and switch-off delay". Configure the desired switch-on delay.
The switch-on delay is enabled. After reception of an ON telegram via the "switching" or "central switching" object, the configurable time is started. Another ON-telegram triggers the time only when the parameter "Switch-on delay retriggerable" is activated. An OFF-telegram received during the ON-delay will end the delay and sets the switching status to "OFF".

Activating switch-off delay

The switch-off delay can be activated separately in the ETS for each switching output.

Precondition:

The time delays must be enabled on the parameter page "Relay output... -> SO... - General -> Enabled" functions.

- Set the parameter "Selection of time delay" to "Switch-off delay" or to "Switch-on delay and switch-off delay". Configure the desired switch-off delay.
The switch-off delay is enabled. After reception of an OFF telegram via the "switching" or "central switching" object, the configurable time is started. Another OFF-telegram triggers the time only when the parameter "switch-off delay retriggerable" is activated. An ON-telegram received during the OFF-delay will end the delay and sets the switching status to "ON".

11.7.1 Parameter time delays

Relay output... -> SO... - General -> Enabled functions

Time delays	Checkbox (yes / no)
This parameter can be used to disable or to enable the time delays. The parameter is deactivated if cyclical monitoring is enabled.	

Relay output... -> SO... - General -> Time delays

Selection of time delay	no time delay Switch-on delay Switch-off delay ON delay and OFF delay
The communication objects "Switching" or "Central switching" can be evaluated after a time delay. By this setting the desired function of the time delay is selected and the additional parameters of the delay enabled.	

Switch-on delay minutes (0...59)	0...59
This parameter is used for setting the duration of the switch-on delay. Sets the switch-on delay minutes.	

Seconds (0...59)	0...10...59
Sets the switch-on delay seconds.	

Switch-on delay retriggerable	Checkbox (yes / no)
A switch-on delay still in progress can be retriggered by another "ON" telegram (parameter activated). Alternatively, the retriggering time (parameter deactivated) can be suppressed. The parameters for the switch-on delay are only visible if switch-on delay or switch-on and switch-off delay are activated.	

Switch-off delay minutes (0...59)	0...59
This parameter is used for setting the duration of the switch-off delay. Sets the switch-off delay minutes.	

Seconds (0...59)	0...10...59
Sets the switch-off delay seconds.	

Switch-off delay retriggerable	Checkbox (yes / no)
A switch-off delay still in progress can be retriggered (parameter activated) by another "OFF" telegram. Alternatively, the retriggering time (parameter deactivated) can be suppressed. The parameters for the switch-off delay are only visible if switch-on delay or switch-on and switch-off delay are activated.	

11.8 Staircase function

The staircase function can be used for implementing time-controlled lighting of a staircase or for function-related applications. The staircase function must be enabled in the ETS on parameter page "Relay output... -> SO... - General -> Enabled functions", in order for the required communication objects and parameters to be visible.

The staircase function is activated via the communication object "Staircase function start / stop" and is independent of the "switching" object of a switching output. In this way, parallel operation of time and normal control is possible, whereby the command last received is always executed: A telegram to the "switching" object or a scene recall at the time of an active staircase function aborts the staircase time prematurely and presets the switching state according to the received object value (the time delays are also taken into account) or scene value. Likewise, the switching state of the "switching" object can be overridden by a staircase function.

Time-independent continuous light switching can also be implemented in combination with a disabling function because the disabling function has a higher priority and overrides the switching state of the staircase function.

The staircase function can also be extended by means of a supplementary function. At the same time, it is possible to activate a time extension. The "time extension" permits retriggering of an activated staircase via the object "Staircase function Start / Stop" n times. Alternatively, the "time preset via the bus" can be set. With this supplementary function, the configured staircase time can be multiplied by a factor received via the bus, thus it can be adapted dynamically.

Furthermore, an extension of the staircase function can be implemented by means of a separate switch-on delay and pre-warning function. The pre-warning should, according to DIN 18015-2, warn any person still on the staircase that the light will soon be switched off.

Specifying switch-on behaviour of the staircase function

An ON telegram to the "Staircase function start/stop" object activates the staircase time (T_{ON}), the duration of which is defined by the parameters "Staircase time". In addition, a switch-on delay (T_{Delay}) can be activated (see "presetting switch-on delay of the staircase function"). At the end of the staircase time, the output switches off or activates optionally the pre-warning time ($T_{Prewarn}$) of the pre-warning function (see "presetting pre-warning function of the staircase function"). Taking into account any possible switch-on delay and pre-warning function, this gives rise to the switch-on behaviour of the staircase function as shown in the following diagram.

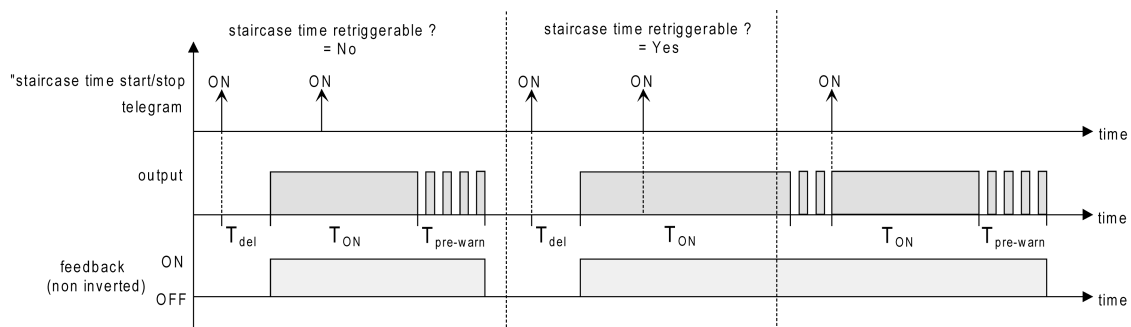

Image 25: Switch-on behaviour of the staircase function

The parameter "Staircase time retriggerable" specifies whether the staircase time can be retriggered.

Precondition:

The staircase function must be enabled on parameter page "Relay output... -> SO... - General -> Enabled functions".

- Activate parameter "Staircase time retriggerable".
Every ON telegram received during the ON phase of the staircase time retriggeres the staircase time completely.
 - Deactivate parameter "Staircase time retriggerable".
ON telegrams received during the ON phase of the staircase time are rejected. The staircase time is not retriggered.
- i** An ON telegram received during the pre-warning time always retriggeres the staircase time independently of the parameter "Staircase time retriggerable".
- i** When the supplementary function "Time extension" is preset, the parameter "Staircase time retriggerable" cannot be adjusted. In this case, it is permanently deactivated.

Specifying switch-off behaviour of the staircase function

In the case of a staircase function, the reaction to an OFF telegram can also be configured on the object "Staircase function start/stop". Without the receipt of an OFF telegram the output switches off after the pre-warning time elapses, if necessary. Taking into account any possible switch-on delay and pre-warning function, this gives rise to the switch-off behaviour of the staircase function as shown in the following diagram.

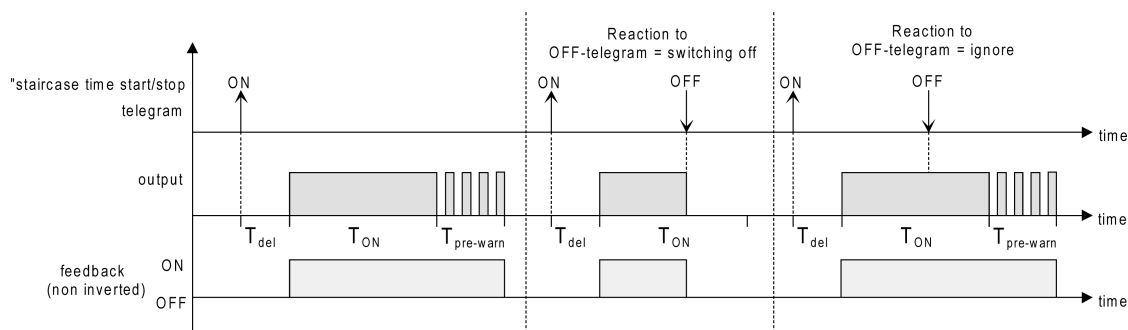

Image 26: Switch-off behaviour of the staircase function

The parameter "reaction to OFF-telegram" defines whether the staircase time (T_{ON}) of the staircase function can be aborted prematurely.

Precondition:

The staircase function must be enabled on parameter page "Relay output... -> SO... - General -> Enabled functions".

- Set parameter "Reaction to OFF-telegram" to "switch off".

As soon as an OFF telegram is received via the object "Staircase function start/stop" during the ON phase of the staircase time, the output switches off immediately. If the staircase time is stopped prematurely by such a telegram, there is no pre-warning, i.e. the pre-warning time is not started.

- Set parameter "Reaction to OFF-telegram" to ignore".
OFF telegrams received during the ON phase of the staircase time are rejected. The staircase time will be executed completely to the end with pre-warning if necessary.
- i** With the supplementary function "time preset via the bus", the staircase time of the staircase function can also be started by the reception of a new time factor. In this case, received "0" factors are interpreted as an OFF telegram. Here too, the parameter "Reaction to OFF telegram" is evaluated so that a staircase time can be cancelled early.
- i** The parameter "Reaction to OFF telegram" does not influence the reception and the evaluation of OFF telegrams via the "Switching" object.

Setting the switch-on delay of the staircase function

An ON telegram for activation of the staircase function can also be evaluated with a time delay. This switch-on delay can be activated separately for the staircase function and has no influence on the configurable time delays for the object "switching".

Precondition:

The staircase function must be enabled on parameter page "Relay output... -> SO... - General -> Enabled functions".

- On the parameter page "Relay output... -> SO... - General -> Staircase function" deactivate the parameter "Switch-on delay".
The switch-on delay is deactivated. After reception of an ON telegram on the object "Staircase function start/stop", the staircase time is activated immediately and the output switched on.
- Activate the parameter "switch-on delay".
The switch-on delay for the staircase function is enabled. The desired switch-on delay time can be specified. After reception of an ON telegram on the object "Staircase function start/stop", the switch-on delay is started. Another ON-telegram triggers the time only when the parameter "Switch-on delay retriggerable" is activated. The staircase time is activated and the output is switched on only after the time delay has elapsed.
- i** An OFF telegram via the object "Staircase function start/stop" during the switch-on delay only terminates the delay if the parameter "Reaction to OFF-telegram" is set to "switch off". Otherwise, the OFF telegram is ignored.
- i** When the supplementary function "Time extension" is preset, the parameter "Switch-on delay retriggerable" cannot be adjusted. In this case, it is permanently deactivated.

Setting the pre-warning function of the staircase function

The pre-warning should, according to DIN 18015-2, warn persons still on the staircase that the light will soon be switched off. The lighting connected on the output is briefly switched off repeatedly as a pre-warning, before the output is switched off permanently. At the same time, the pre-warning time (T_{Prewarn}), the duration of the interruptions during the pre-warning ($T_{\text{Interrupt}}$) and the number of pre-warning interruptions are configurable (see figure 27). The pre-warning time is added to the staircase time (T_{ON}). The pre-warning time influences the value of the feedback object so that the value "OFF" (in the case of non-inverted transmission) is first tracked after the pre-warning time in the object has elapsed.

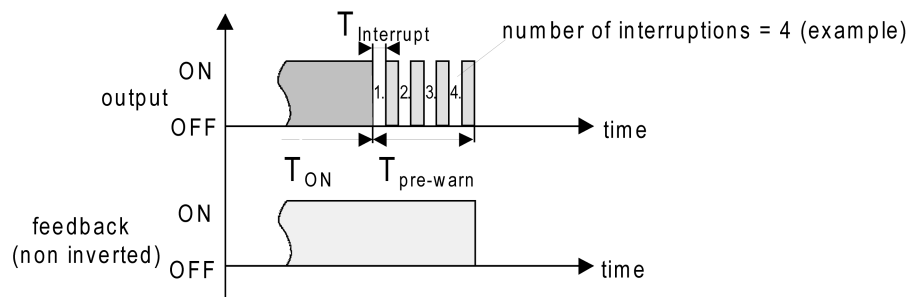

Image 27: The pre-warning function of the staircase function (example)

Precondition:

The staircase function must be enabled on parameter page "Relay output... -> SO... - General -> Enabled functions".

- On the parameter page "Relay output... -> SO... - General -> Staircase function" set the parameter "At the end of the staircase time" to "activate pre-warning time".
 The pre-warning function is enabled. The desired pre-warning time (T_{Prewarn}) can be preset.
 - Set the parameter "Number of pre-warnings" to the desired value (1...10).
 Within the pre-warning time, the lighting connected on the output is switched off just as often as configured here. The 1st pre-warning is always executed at the beginning of the entire pre-warning time.
 - Set the parameters "Time for pre-warning interruptions" to the desired value.
 An interruption ($T_{\text{Interrupt}}$) during the pre-warning time is just as long as configured here. The adjustable interruption time allows the switch-off phase of the lighting to be adapted individually to the lamps used.
- i** It should be noted that the "number of pre-warnings" and the "time for pre-warning interruptions" must be attuned to the duration of the entire "pre-warning time". Hence, the entire switch-off phase during a pre-warning ("number of pre-warnings" + "time for pre-warning interruptions") must not be set longer than the pre-warning time! Otherwise, malfunctions can be expected.

- i** An ON telegram to the object "Staircase function start/stop" while a pre-warning function is still in progress stops the pre-warning time and always restarts the staircase time (independently of the parameter "Staircase time retriggerable"). Even during the pre-warning time, the parameter "reaction to OFF telegram" is evaluated so that a pre-warning in progress can be terminated early by switching off.

Setting supplementary function of the staircase function – time extension

With the time extension function, the staircase time can be retriggered several times (i.e. extended) via the "Staircase function start/stop" object. The duration of the extension is predefined by several operations at the control section (several ON telegrams in succession). The configured staircase time can be extended in this way by the configured factor (a maximum of 5-fold). The time is then always extended automatically at the end of a single staircase time (T_{ON}) (see figure 28).

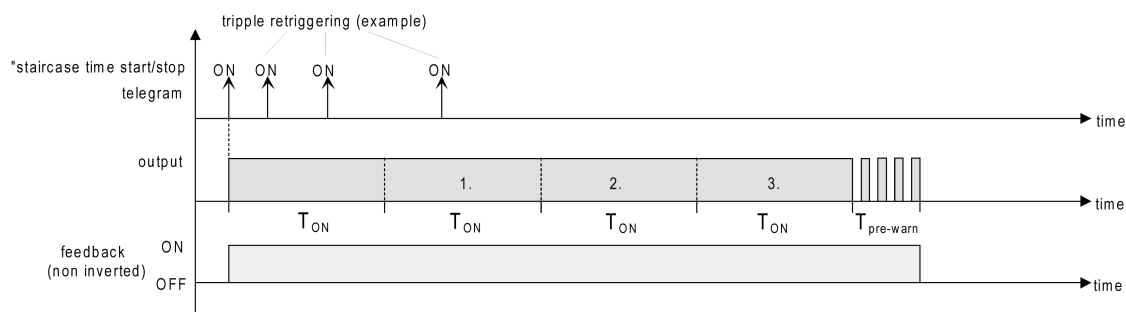

Image 28: Time extension of the staircase function

With this function, the lighting time in a staircase can be extended (e.g. by a person after shopping) by a defined length without having to retrigger the lighting every time the lighting shuts off automatically.

Precondition:

The staircase function must be enabled on parameter page "Relay output... -> SO... - General -> Enabled functions.

- On the parameter page "Relay output... -> SO... - General -> Staircase function" Set the parameter "Supplementary function for staircase function" to "time extension" and set the maximum desired factor on the parameter "maximum time extension".

The staircase time is retriggered each time an ON telegram is received on the "staircase time start/stop" object after the staircase time has elapsed, depending on the number of telegrams received, but only as often as pre-defined by the configured factor.

For example, the "3-fold time" setting means that after the started staircase time has elapsed, it can be retriggered automatically a maximum of three additional times. The time is therefore extended a maximum of four fold.

- i** A time extension can be triggered during the entire staircase time (T_{ON}). There is no time limit between two telegrams for the time extension. Telegrams for the time extension are only evaluated during the staircase time. An ON telegram during the pre-warning function triggers the staircase time as a restart,

which means that a new time extension is possible.

If a switch-on delay was configured, the time extension is recorded during the switch-on delay.

- i** If a time extension was configured as a supplementary function, the parameters "Staircase time retriggerable" and "Switch-on delay retriggerable" are permanently deactivated since the staircase time can be retriggered by the time extension.

Setting supplementary function of the staircase function – time preset via the bus

With time specification via the bus, the configured staircase time can be multiplied by an 8-bit factor received via the KNX, thus it can be adapted dynamically. With this setting, the factor is derived from the object "staircase time factor". The possible factor value for setting the staircase time is between 1...255.

The entire staircase time arises as a product from factor (object value) and the configured staircase time as a basis as follows...

Staircase time = (staircase time object value) x (staircase time parameter)

Example:

Object value "staircase time factor" = 5; parameter "staircase value" = 10s.

-> set staircase time = 5 x 10s = 50 s.

Alternatively, the staircase function parameter can define whether the receipt of a new factor also starts the staircase time of the staircase function at the same time. In this case, the object "Staircase function start/stop" is not necessary and the received factor value determines the starting and stopping.

Precondition:

The staircase function must be enabled on parameter page "Relay output... -> SO... - General -> Enabled functions.

- On the parameter page "Relay output... -> SO... - General -> staircase function" Set the parameter "supplementary function for staircase function" to "time preset via the bus" and deactivate the parameter "staircase function activatable via 'staircase time' object".

The staircase time can be adapted dynamically by the "staircase time factor" object. A value "0" is interpreted as value "1". The staircase function is started and stopped exclusively via the "staircase function start / stop" object.

- Activate the parameter "supplementary function" to "time preset via the bus" and activate the parameter "staircase function activatable via 'staircase time' object".

The staircase time can be adapted dynamically by the "staircase time factor" object. In addition, the staircase function is started with the new staircase time (the object "staircase function start / stop" is not necessary). A factor value "0" is interpreted as an OFF telegram, whereby in this case, the configured reac-

tion to an OFF telegram is evaluated, too.

A larger staircase with several floors is an example as an application for the time preset via the bus with automatic starting of the staircase time. On each floor there is a push-button sensor that transmits a factor value to the staircase function. The higher the floor, the greater the factor value transmitted so that the lighting stays switched on longer if the passing through the staircase needs more time. When a person enters a staircase and a pushbutton is pressed, the staircase time is now adjusted dynamically to the staircase time and switches on the lighting at the same time, too.

- i** The staircase function is started via the reception of a new factor: A factor > 0 received during a pre-warning time always triggers the staircase time independently of the parameter "Staircase time retriggerable".
- i** After a reset (bus voltage return or ETS programming) the "staircase time factor" object is always initialised with "1". However, the staircase function is not started automatically solely as the result of this (see "Set behaviour of staircase function after bus voltage return").
- i** The two supplementary functions "time extension" and "time preset via the bus" can only be configured alternatively.

Setting the behaviour of the staircase function after bus voltage return

The staircase function can optionally be started automatically after bus voltage return.

Precondition:

The staircase function must be enabled on parameter page "Relay output... -> SO... - General -> Enabled functions".

- On the parameter page "Relay output... -> SO... - General", set the parameter "After bus voltage return" to "Activate staircase function".
Immediately after bus voltage return, the staircase time of the staircase function is started.
- i** During automatic starting of the staircase function after bus voltage return, no switch-on delay is started if the staircase function has configured such a delay.
- i** The device only executes the configured "Behaviour on bus voltage return" only if the last ETS programming of the application or of the parameters ended at least approx. 20 s prior to switching on the bus voltage. Otherwise ($T_{ETS} < 20$ s) the behaviour "after ETS programming" will be adopted also in case of bus voltage return.
- i** The configured behaviour will only be executed, if no forced position on bus voltage return is activated.

11.8.1 Parameter Staircase function

Relay output... -> SO... - General -> Enabled functions

Staircase function	Checkbox (yes / no)
This parameter can be used to disable or to enable the staircase function. The parameter is deactivated if cyclical monitoring is enabled.	

Relay output... -> SO... - General -> Staircase function

Staircase time hours (0...23)	0...23
This parameter is used for programming the duration of the switch-on time for a scene recall. Switch-on time hours setting.	

Minutes (0...59)	0...3...59
Switch-on time minutes setting.	

Seconds (0...59)	0...59
Switch-on time seconds setting.	

Staircase time retriggerable	Checkbox (yes / no)
An active switch-on time can be retriggered (parameter activated). Alternatively, the retriggering time (parameter deactivated) can be suppressed. This parameter is preset to deactivated if the supplementary function "Time extension" is configured. Re-triggering will not be possible.	

Switch-on delay	Checkbox (yes / no)
The staircase function enables the activation of an own switch-on delay. This switch-on delay affects the trigger result of the staircase function and thus delays the switch-on.	
<p>activated: The switch-on delay for the staircase function is enabled. After reception of an ON telegram on the object "Staircase function start/stop", the switch-on delay is started. Another ON-telegram triggers the time only when the parameter "Switch-on delay retriggerable" is activated. The staircase time is activated and the output is switched on only after the time delay has elapsed.</p> <p>deactivated: The switch-on delay is deactivated. After reception of an ON telegram on the object "Staircase function start/stop", the staircase time is activated immediately and the output switched on.</p>	

Switch-on delay hours (0...23)	0...23
This parameter is used for setting the duration of the switch-on delay. Sets the switch-on delay hours.	

Minutes (0...59)	0...59
Sets the switch-on delay minutes.	

Seconds (0...59)	0...30...59
Sets the switch-on delay seconds.	

Switch-on delay retriggerable	Checkbox (yes / no)
<p>An active switch-on delay can be retriggered (parameter activated). Alternatively, the retriggering time (parameter deactivated) can be suppressed.</p> <p>This parameter is deactivated if the supplementary function "Time extension" is configured. Re-triggering will not be possible.</p> <p>The parameters for the switch-on delay are only visible when the switch-on delay is used.</p>	
Reaction to OFF-telegram	switch off ignore
<p>An active switch-on time can be aborted prematurely by switching off the staircase function.</p> <p>switch off: The switch-on time is aborted after receipt of an OFF telegram on the object "Staircase time start/stop".</p> <p>With the supplementary function "time preset via the bus" and the setting "Staircase function activatable via object 'Staircase time' = activated" the switch-on time can also be prematurely ended by a factor of "0".</p> <p>ignore: OFF Telegrams or "0" factors are ignored. The switch-on time will be executed completely to the end.</p>	
Supplementary function	no supplementary function time extension time preset via the bus
<p>The staircase function can be extended by the two supplementary functions "Time extension" and "Time specifications via bus", which should be used alternatively. This parameter enables the desired supplementary function and thereby activates the necessary parameters or objects.</p> <p>no supplementary function: No supplementary function is enabled.</p> <p>Time extension: The time extension is activated. This function permits retriggering an activated staircase lighting time span-times via the object "Staircase function start/stop".</p> <p>Time preset via the bus: The time preset via the bus is activated. With this supplementary function, the configured switch-on time can be multiplied by a factor received via the KNX, thus it can be adapted dynamically.</p>	

Maximum time extension	1-fold staircase time 2-fold staircase time 3-fold staircase time 4-fold staircase time 5-fold staircase time
<p>In case of a time extension (retriggering the lighting time n-times via the object "Staircase function start/stop), the parameterized staircase lighting time will be extended by the value programmed in this parameter.</p> <p>"1-fold staircase time" means that after the started staircase time has elapsed, it can be retriggered a maximum of one more time. The time is therefore extended two fold. The other settings behave in a similar manner.</p> <p>This parameter is visible only if the supplementary function "time extension" is set.</p>	
Staircase function activatable via "Staircase time" object	Checkbox (yes / no)
<p>A time preset via the bus can specify here whether the receipt of a new time factor also starts the switch-on time (parameter activated). At the same time, the object "Staircase function start/stop" is hidden.</p> <p>If the parameter is deactivated, the switch-on time can be activated exclusively via the object "Staircase function start/stop".</p> <p>This parameter is visible only if the supplementary function "time preset via the bus" is set.</p>	
At the end of the staircase time	switch off activate pre-warning time
<p>At the end of the staircase time, the actuator for the switching output concerned displays the configured behaviour here. The output can be set to switch off immediately or alternatively to execute a pre-warning function.</p> <p>switch off: At the end of the staircase time, the actuator switches off the switching output concerned.</p> <p>Activate pre-warning time: At the end of the staircase time, the switching output can generate a pre-warning prior to switching off. The pre-warning, for example, should warn any person still on the staircase that the light will soon be switched off.</p>	
Pre-warning time minutes (0...59)	0...59
<p>This parameter is used for setting the duration of the pre-warning time. The pre-warning time is added to the switch-on time. Sets the pre-warning time in minutes.</p>	
Seconds (0...59)	0... 30 ...59
<p>Sets the pre-warning time in seconds.</p> <p>These parameters are visible only if the pre-warning function is enabled.</p>	

Time for early warning interruptions seconds (0...59)	0...59
This parameter defines the duration of a pre-warning interruption, i.e. how long the switching output is to remain off during a pre-warning interruption. The time should be customized individually to the switch-off behaviour of the lamp used. Sets the pre-warning interruption seconds.	
Milliseconds (0...900)	0...500...900
Sets the pre-warning interruption milliseconds (in 100-ms increments).	
Number of pre-warnings(1...10)	1...3..10
This parameter defines how often the switching output is to switch off within the pre-warning time. i.e. how many pre-warnings will be generated.	

11.8.2 Object list staircase function

Object no.	Function	Name	Type	DPT	Flag
332, 352...	Staircase function start/stop	Switching... - Input	1-bit	1,010	C, (R), W, -, A
1-bit object to activate or deactivate the switch-on time of the staircase function of a switching output ("1" = switch-on / "0" = switch-off).					
Object no.	Function	Name	Type	DPT	Flag
333, 353...	Staircase time factor	Switching... - Input	1 bytes	5,010	C, (R), W, -, A
1-byte object to specify a time factor for the switch-on time of the staircase function (value range: 0... 255).					

11.9 Scene function

Up to 64 scenes can be programmed and scene values stored separately for each switching output. The scene values are recalled or stored via a separate scene extension object. The data point type of the extension object permits addressing of all 64 scenes.

The scene function must be enabled on parameter page "Relay output... -> SO... - General -> Enabled functions" for each switching output, in order for the required communication objects and parameters (on the parameter page "Relay output... -> SO... - General -> Scenes") to become visible.

The scene configuration selected in the parameterization decides whether the number of scenes is either variable (1 ... 64) or alternatively fixed to the maximum (64).

- Scene configuration = "variable (1 ... 64 scenes)"
With this setting, the number of scenes used can be selected anywhere in the range 1 to 64. The parameter "Number of scenes" decides how many scenes are visible for the switching output in the ETS and can therefore be used. It is possible to specify which scene number (1 ... 64) controls each scene.
- Scene configuration = "fixed (64 scenes)"
With this setting, all scenes are always visible and can therefore be used. The scenes are controlled via permanently assigned scene numbers (1 ... 64) (scene number 1 -> scene 1, scene number 2 -> scene 2 ...). If necessary, individual scenes can be deactivated.

The scene function can be combined together with other functions of a switching output, whereby the last received or preset state is always executed:

Telegrams to the "Switching" objects, a scene recall or scene storage telegram at the time of an active staircase function aborts the staircase time prematurely and presets the brightness state according to the received object value (time delays are also taken into account) or scene value.

Similarly, the state of the switching output, which was preset by the "Switching", "Dimming" or "Brightness value" objects or by a scene recall, can be overridden by a staircase function.

Presetting a scene recall delay

Each scene recall of a switching output can optionally also be delayed. With this feature, dynamic scene sequences can be configured if several scene outputs are combined with cyclical scene telegrams.

Precondition

The scene function must be enabled on parameter page "Relay output... -> SO... - General -> Enabled functions".

- On the parameter page "Relay output... -> SO... - General -> Scenes" activate the parameter "Delay scene recall".

The delay time is now activated and can be configured separately. The delay only influences the scene recall of the switching output. The delay time is started on arrival of a recall telegram. The corresponding scene will be recalled and the switching channel set to the switching state value only after this time has elapsed.

- i** Each scene recall telegram restarts the delay time and retriggers it. If a new scene recall telegram is received while a delay is active (scene recall not yet executed), the old (and not yet recalled scene) will be rejected and only the scene last received executed.
- i** The scene recall delay has no influence on the storage of scene values. A scene storage telegram within a scene recall delay terminates the delay and thus the scene recall.

Presetting the behaviour during ETS programming

When a scene is saved, the switching states are saved permanently in the device. To prevent the stored values from being replaced during ETS programming of the application or parameters by the originally programmed scene switching states, the actuator can inhibit overwriting of the switching states. As an alternative, the original values can be reloaded into the device during each programming run of the ETS.

Precondition

The scene function must be enabled on parameter page "Relay output... -> SO... - General -> Enabled functions".

- On the parameter page "Relay output... -> SO... - General -> Scenes", activate the parameter "Overwrite values stored in the device during the ETS programming operation".

During each ETS programming operation of the application or of the parameters, the scene switching states configured in the ETS for the switching output concerned will be programmed into the actuator. Scene switching states stored in the device by means of a storage function will be overwritten, if any.

- Deactivate the parameter "Overwrite values stored in the device during the ETS programming operation".

Scene switching states stored in the device with a storage function will be maintained. If no scene switching states have been stored, the switching states last programmed in the ETS remain valid.

- i** When the actuator is commissioned for the first time, this parameter should be activated so that the switching output is initialised with valid scene switching states.

Setting scene numbers and scene switching states

The presetting of the scene number depends on the selected scene configuration. With variable configuration the scene number (1...64) with which the scene is addressed, i.e. recalled or stored, must be determined for each scene of the switching

output. With a fixed scene configuration, the number of a scene is preset invariably. The data point type of the scene extension object permits addressing of up to 64 scenes max.

In addition to specifying the scene number, it is necessary to define which scene command (ON, OFF) should be set on the switching output during a scene recall.

Precondition

The scene function must be enabled on parameter page "Relay output... -> SO... - General -> Enabled functions".

- Only with variable scene configuration. On the parameter page "Relay output... -> SO... - General -> Scenes", set the parameter for each scene to the numbers with which the scenes are to be addressed.

A scene can be addressed with the configured scene number. A setting of "0" deactivates the corresponding scene so that neither recalling nor storage is possible.

- Only with fixed scene configuration. On the parameter page "Relay output... -> SO... - General -> Scenes" select or deselect the parameter "Scene active" if necessary.

Only selected scenes can be used. A deselected scene is deactivated and cannot be recalled or stored via the scene extension.

i If with variable scene configuration the same scene number is configured for several scenes, only the scene with the lowest sequential number will be addressed. The other scenes will be ignored in this case.

- On the parameter page "Relay output... -> SO... - General -> Scenes" set the parameter "Switching state for each scene to the desired switching command. During a scene recall, the configured switching state is recalled and set on the switching output.

i The configured switching state is adopted in the actuator during programming with the ETS only if the parameter "Overwrite values stored in the device during ETS download" is activated.

Presetting storage behaviour

The switching state set for the switching output can be stored internally via the extension object on reception of a scene storage telegram. In this case, the switching state can be influenced before the storage by all functions of the switching output provided that the individual functions have been enabled (e.g. also the disabling function, forced-control position function etc.).

Precondition

The scene function must be enabled on parameter page "Relay output... -> SO... - General -> Enabled functions".

- On the parameter page "Relay output... -> SO... - General -> Scenes" activate the parameter "storage function" for each scene.

The storage function is activated for the scene in question. On reception of a storage telegram via the "Scene extension" object, the current switching state will be internally stored.

- Deactivate the parameter "storage function" for each scene.

The storage function is deactivated for the scene in question. A storage telegram received via the "scene extension" object will be rejected.

Optionally, a visual feedback via the switching output can be signaled when executing a storage command. The channel flashes once as feedback in the configured flashing time. This enables the system operator to determine locally whether the desired scene switching state has been saved correctly in the actuator. A switching state feedback on the KNX is not generated.

- On the parameter page "Relay output... -> SO... - General -> Scenes" activate the parameter "visual feedback for storage function". In the parameter "Flashing time", set the time in which the visual feedback is to be executed.

When a storage function is executed, the visual feedback is activated immediately. The output switches to the opposite switching state for the duration of the configured flashing time and then back to the saved scene command.

- Deactivate the parameter "visual feedback for storage function".

When storing a scene, the visual feedback is not executed. The actuator adopts the current switching state of the output without special feedback.

- i** The visual feedback is only executed if no other function with a higher priority (e.g. disabling function) is active in the moment when the memory function is active.

Configure extended scene recall

The extended scene recall allows recalling of up to 64 scenes of the switching output in sequence. Here, scene recall takes place via the 1-bit communication object "Extended scene recall". Each ON telegram received via this object recalls the next of the available scenes in the configuration. Each OFF telegram received recalls the previous scene.

With the extended scene recall, the actuator always recalls the neighbouring scene - starting with the scene most recently recalled via the extended recall. It is irrelevant whether the scene is active on the appropriate switching output (scene number = "1...64" or scene active) or inactive (scene number = "0" or scene inactive). If an inactive scene is recalled via the extended scene recall, the appropriate switching output will not react.

Only the scenes available in the scene configuration can be selected via the extended scene recall (with "variable" defined by the parameter "number of scenes", with "fixed" always all 64 scenes). After a reset (bus voltage return, ETS programming operation), an ON or OFF telegram always recalls scene 1 first.

- i** Recall of a scene via the 1-byte extension object does not influence the scene sequence of the extended scene recall. The two recall functions work independently of each other.

- Activate the parameter "Extended scene recall" on the parameter page "Relay output... -> SO... - General -> Scenes".

The object "Extended scene recall" is available. Each ON telegram recalls the next scene. Each OFF telegram recalls the previous scene.

- Deactivate the parameter "Use extended scene recall".

The extended scene recall is deactivated. A scene recall can only take place via the 1-byte scene extension object.

The extended scene recall can take place with or without an overflow at the scene limits. An overflow occurs when the last scene of the selected configuration is reached when counting up or scene 1 when counting down and an additional telegram in the last counting direction is received by the actuator. The overflow behaviour is defined in the ETS.

- Activate the parameter "with overflow".

After reaching the last scene of the selected configuration, a further ON telegram of the overflow is executed and scene 1 is recalled. Similarly, after reaching scene 1, the overflow is executed by further OFF telegram and the last scene of the selected configuration is recalled.

- Deactivate the parameter "With overflow".

A scene overflow is not possible. After reaching the last scene of the selected configuration, further ON telegrams of the extended scene recall are ignored. In the same way, the actuator ignores further OFF telegrams if scene 1 was recalled last.

11.9.1 Parameter scene function

Relay output... -> SO... - General -> Enabled functions

Scene function	Checkbox (yes / no)
This parameter can be used disable or to enable the scene function. The parameter is deactivated if cyclical monitoring is enabled.	

Relay output... -> SO... - General: -> Scenes

Delay scene recall	Checkbox (yes / no)
A scene is recalled via the scene extension object. If required, the scene recall can be delayed on reception of a recall telegram (parameter activated). The recall is alternatively made immediately on reception of the telegram (parameter deactivated)	

Delay time minutes (0...59)	0...59
This parameter specifies the length of the scene delay time. Sets the scene delay time in minutes.	

Seconds (0...59)	0...10...59
Sets the scene delay time in seconds. The delay time parameters are only visible, if the parameter "Delay scene recall" is activated.	

Visual feedback for storage function	Checkbox (yes / no)
Optionally, a visual feedback via the switching output can be signaled when executing a storage command. The channel flashes once as feedback in the configured flashing time. Parameter activated: When a storage function is executed, the visual feedback is activated immediately. The output switches to the opposite switching state for the duration of the configured flashing time and then back to the saved scene command. Parameter deactivated: When storing a scene, the visual feedback is not executed. The actuator adopts the current switching state of the output without special feedback.	

Flashing time (0...10)	0...5...10
The flashing time in which the visual feedback is to be executed is set here. This parameter is only visible when visual feedback is used.	

Overwrite values stored in the device during the ETS programming operation	Checkbox (yes / no)
During storage of a scene, the scene values (current states of the switching outputs concerned) are stored internally in the device. To prevent the stored values from being replaced during ETS programming by the originally programmed scene values, the actuator can inhibit overwriting of the scene values (parameter deactivated). As an alternative, the original values can be reloaded into the device during each programming run of the ETS (parameter activated).	

Use extended scene recall	Checkbox (yes / no)
<p>The extended scene recall allows recalling of up to 64 scenes of the switching output in sequence. Here, scene recall takes place via the 1-bit communication object "Extended scene recall". Each ON telegram received via this object recalls the next scene. Each OFF telegram received recalls the previous scene.</p> <p>This parameter enables extended scene recall, if required.</p>	
With overflow	Checkbox (yes / no)
<p>The extended scene recall can take place with or without an overflow at the scene limits. An overflow occurs when the last scene of the selected configuration is reached when counting up or scene 1 when counting down and an additional telegram in the last counting direction is received by the actuator.</p> <p>Parameter activated: After reaching the last scene of the selected configuration, a further ON telegram of the overflow is executed and scene 1 is recalled. Similarly, after reaching scene 1, the overflow is executed by further OFF telegram and the last scene of the selected configuration is recalled.</p> <p>Parameter deactivated: A scene overflow is not possible. After reaching the last scene of the selected configuration, further ON telegrams of the extended scene recall are ignored. In the same way, the actuator ignores further OFF telegrams if scene 1 was recalled last.</p> <p>This parameter is only visible when the extended scene recall is used.</p>	
Scene configuration	variable (1...64 scenes) fixed (64 scenes)
<p>The scene configuration selected here decides whether the number of scenes is either variable (1 ... 64) or alternatively fixed to the maximum (64).</p> <p>variable (1...64 scenes): With this setting, the number of scenes used can be selected anywhere in the range 1 to 64. The parameter "Number of scenes" decides how many scenes are visible for the switching output in the ETS and can therefore be used. It is possible to specify which scene number (1 ... 64) controls each scene.</p> <p>fixed (64 scenes): With this setting, all scenes are always visible and can therefore be used. The scenes are controlled via permanently assigned scene numbers (1 ... 64) (scene number 1 -> scene 1, scene number 2 -> scene 2 ...). If necessary, individual scenes can be deactivated.</p>	
Number of scenes (1...64)	1...10...64
<p>This parameter is only available with variable scene configuration and defines how many scenes are visible for the switching output in the ETS and can therefore be used.</p>	

Scene number	0...1*...64 *: The predefined scene number is dependent on the scene (1...64).
<p>With variable scene configuration, the number of scenes used can be selected anywhere in the range 1 to 64. It is then possible to preset which scene number (1 ... 64) controls each scene.</p> <p>A setting of "0" deactivates the corresponding scene so that neither recalling nor storage is possible. If the same scene number is configured for several scenes, only the scene with the lowest sequential number will be addressed. The other scenes will be ignored in this case.</p> <p>This parameter is only available with variable scene configuration.</p>	
Scene active	Checkbox (yes / no)
<p>With a fixed scene configuration, individual scenes can be activated or deactivated. Only activated scenes can be used. A deactivated scene cannot be recalled or stored via the scene extension.</p> <p>This parameter is only available with fixed scene configuration.</p>	
Switching state	ON OFF
<p>This parameter is used for configuring the switching state which is set when the scene is recalled.</p>	
Memory function	Checkbox (yes / no)
<p>If the parameter is activated, the storage function of the scene is enabled. The current switching state can then be stored internally via the extension object on receipt of a storage telegram. If the parameter is deactivated, the storage telegrams are rejected.</p>	

11.9.2 Object list scene function

Object no.	Function	Name	Type	DPT	Flag
328, 348...	Scene extension	Switching... - Input	1 bytes	18,001	C, (R), W, -, A
1-byte object for polling or saving a scene.					

Object no.	Function	Name	Type	DPT	Flag
329, 349...	Extended scene recall	Switching... - Input	1-bit	1,001	C, (R), W, -, A
1-bit object for extended scene recall. Each ON telegram received recalls the next scene of a switching output in sequence. Each OFF telegram received recalls the previous scene. After a reset (bus voltage return, ETS programming operation), an ON or OFF telegram always recalls scene 1 first.					

11.10 Disabling function and forced position

A disabling function, or alternatively, a forced position function can be configured for each switching output. In this respect, only one of these functions can be enabled for one switching output.

Presetting disabling function

During an active disabling function, the KNX operation of the switching output concerned is overridden and locked. Continuous light switching, for example, can also be overridden. The deactivation of the disabling function can optionally take place using an additional 1-bit acknowledgement object. This prevents the deactivation of the disabling function by the disabling object.

- On the parameter page "Relay output... -> SO... - General -> Enabled functions" Set the parameter "disabling function / forced position" to "disabling function".

The disabling function is enabled. The communication object "Disable" and the parameters of the disabling function on the parameter page "Relay output... -> SO... - General -> Disabling function" become visible.

- Set the parameter "Polarity disabling object" to the desired polarity.
- Set the parameter "Beginning of the disabling function" to the required behaviour.

At the beginning of the disabling function, the configured behaviour will be executed and bus operation of the switching output locked.

When the setting "No change of switching state" is selected, the relay of the output shows no reaction and remains in the switching state last set (switching state in acc. with last non-inverted feedback telegram).

In the "Flashing" setting, the switching output is switched on and off cyclically during the disabling. The "Time for flashing the disabling functions" is generally configured for all outputs on the parameter page General -> "General switching outputs". During flashing, the logical switching state of the switching output is fed back as "Switched on".

For disabling function without acknowledgement object...

- Deactivate the parameter "Use acknowledgment".

No additional acknowledgement object is available. The disabling function is deactivated by the disabling object according to the set polarity.

- Set the parameter "End of the disabling function" to the required behaviour.

At the end of the disabling function, the configured behaviour will be executed and the bus operation of the switching output enabled again.

In the "No change of switching state" setting, the relay of the output shows no reaction and remains in the state last set by the disabling function.

In "Set tracked state", the last switching state received during the disabling function or the switching state set before the disabling function will be tracked. Any time functions still in progress will also be taken into account if necessary.

In the "Flashing" setting, the switching output is switched on and off cyclically after the disabling. The time for flashing is generally configured for all outputs on the parameter page "General -> General switching outputs". During flashing, the logical switching state of the output is fed back as "Switched on". The flashing state remains active until another KNX command is received and thereby predefines another switching state.

For disabling function with acknowledgement object...

- Activate the parameter "Use acknowledgment"

The acknowledgement object is available. The disabling function can only be deactivated using the acknowledgement object by an ON telegram. Telegrams to the disabling object according to the "Deactivate disabling" polarity are ignored by the actuator.

i "OFF" telegrams to the acknowledgement object do not product a reaction.

- Set the parameter "End of the disabling function after acknowledgement" to the required behaviour.

After an acknowledgement, the configured behaviour will be executed and the bus operation of the switching output enabled again.

In the "No change of switching state" setting, the relay of the output shows no reaction and remains in the state last set by the disabling function.

On acknowledgement in "Set tracked state", the last switching state received during the disabling function or the switching state set before the disabling function will be tracked. Any time functions still in progress will also be taken into account if necessary.

In the "Flashing" setting, the switching output is switched on and off cyclically after the acknowledgement. The time for flashing is generally configured for all outputs on the parameter page "General -> General switching outputs". During flashing, the logical switching state of the output is fed back as "Switched on". The flashing state remains active until another KNX command is received and thereby predefines another switching state.

i After a bus failure or after programming the application or the parameters with the ETS, the disabling function is always deactivated (object value "0"). With the inverted setting "1 = enabled; 0 = disabled", a telegram update "0" must first be carried out after the initialisation until the disabling is activated.

i Updates of the disabling object from "activated" to "deactivated" do not produce a reaction.

i The relay of a switching output disabled via the KNX can still be operated manually.

- i** In the setting "Set tracked state": During a disabling function, the overridden functions of the actuator (switching, scenes) continue to be executed internally. Consequently, newly received bus telegrams are evaluated and time functions are triggered as well. At the end of the disabling, the tracked states are set.

Setting forced position function

The forced position function can also be combined with other functions of a switching output. With an active forced position, functions with a lower priority are overridden so that the switching output concerned is locked.

The forced position function possesses a separate 2-bit communication object. The first bit (Bit 0) of the object "Forced position" indicates whether the switching output is switched off or switched on by force. The second bit (bit 1) activates or deactivates the forced-position state (see table below).

The behaviour of a switching output at the end of the forced position can be configured. In addition, the forced object can be initialised on bus voltage return.

Bit 1	Bit 0	Function
0	x	Forced position not active -> normal control
1	0	Forced position active: switch off
1	1	Forced position active: switch on

Table 2: Bit coding of forced position

- On the parameter page "Relay output... -> SO... - General -> Enabled functions" Set the parameter "disabling function" to "forced position".

The forced position function is enabled. The communication object "forced position" and the parameter of the forced position function on the parameter page "Relay output... -> SO... - General -> Forced position" become visible.

- Set the parameter "forced position end 'inactive'" to the required behaviour. At the end of the forced position, the configured behaviour will be executed and the bus operation of the switching output enabled again.

In the "No change of switching state" setting, the relay of the output shows no reaction and remains in the state last set by the forced position.

In the "Track switching state", the state received during the forced position function or the switching state set before the function can be tracked at the end of the forced position. Any time functions still in progress will also be taken into account if necessary.

- i** Updates of the forced position object from "Forced position active" to "Forced position active" while maintaining the switching status or from "Forced position inactive" to "Forced position inactive" show no reaction.

- i** A switching output forcibly activated via the KNX can be still be operated manually!

- i** In the setting "Track switching state" at the end of the forced position: During a forced position, the overridden functions of the actuator (switching, scenes) continue to be executed internally. Consequently, newly received bus telegrams are evaluated and time functions are triggered as well. At the forced end, the tracked states are set.
- i** The current state of the forced position object will be stored in case of bus voltage failure.

 - Set the parameter "After bus voltage return" to the required behaviour.
After bus voltage return, the configured state is transferred to the "Forced position" communication object. When a forced position is activated, the switching output is immediately activated and interlocked accordingly by forced control after bus voltage return until a forced position is enabled via the KNX. The parameter "After bus voltage return" on the parameter page "Relay output... -> SO... - General" is not evaluated for the affected switching output in this case.

In the "state before bus voltage failure" setting, the forced position state last selected and internally stored before bus voltage failure will be tracked after bus voltage return. An ETS programming operation deletes the stored state (reaction in that case same as with "no forced position active").

If the tracked state corresponds to "No forced position", the force-independent parameter "After bus voltage return" (parameter page "Relay output... -> SO... - General") will be executed on return of bus voltage.
- i** After programming the application or parameters with the ETS, the forced position function is always deactivated (object value "0").

11.10.1 Parameter disabling function and forced position

General -> General switching outputs

Time for flashing the disabling functions	1 s 2 s 5 s 10 s
---	----------------------------------

Switching outputs can flash in the disabled state (cyclical switching on and off). The flashing time is generally configured here.

Relay output... -> SO... - General -> Enabled functions

Disabling function / Forced position	no selection disabling function forced position
--------------------------------------	--

It can be defined here whether a disabling function or a forced position for the switching output should be available. The disabling function is only configurable as an alternative to the forced position function.

Relay output... -> SO... - General -> Disabling function

Acknowledgment	Checkbox (yes / no)
<p>The deactivation of the disabling function can optionally take place using an additional 1-bit acknowledgement object. This prevents the deactivation of the disabling function by the disabling object. Alternatively, the acknowledgement object is not available. In this case, disabling is deactivated via the disabling object.</p> <p>Parameter activated: The acknowledgement object is available. The disabling function can only be deactivated using the acknowledgement object by an ON telegram. Telegrams to the disabling object according to the "Deactivate disabling" polarity are ignored by the actuator.</p> <p>Parameter deactivated: No additional acknowledgement object is available. The disabling function is deactivated by the disabling object according to the set polarity.</p>	

Polarity of the disabling object	0 = disabled; 1 = enabled 1 = enabled; 0 = disabled
----------------------------------	--

This parameter defines the polarity of the disabling object.
 This parameter is visible only if the disabling function is enabled.

Beginning of the disabling function	no change to the switching state switch off switch on flashing
<p>The behaviour of the switching output at the beginning of the disabling function can be configured.</p> <p>This parameter is visible only if the disabling function is enabled.</p> <p>no change of switching state: The relay of the output shows no reaction and remains in the switching state last set (switching state in acc. with last non-inverted feedback telegram).</p> <p>Switch off: At the beginning of the disabling function, the switching output is switched off and locked.</p> <p>Switch on: At the beginning of the disabling function, the switching output is switched on and locked.</p> <p>Flash: The switching output is switched on and off cyclically during the disabling. The "time for flashing" is generally configured for all outputs on the parameter page "General switching outputs". During flashing, the logical switching state of the switching output is fed back as "Switched on".</p>	
End of the disabling function	no change to the switching state switch off switch on set tracked state flashing
<p>The behaviour of the switching output at the end of the disabling function can be configured.</p> <p>This parameter is visible only if the disabling function is enabled and acknowledgement is not used.</p> <p>no change of switching state: The relay of the output shows no reaction and remains in the state last set by the disabling function.</p> <p>Switch off: At the end of the disabling function, the switching output is switched off and enabled again.</p> <p>Switch on: At the end of the disabling function, the switching output is switched on and enabled again.</p> <p>Set tracked state: The last switching state received during the disabling function or the switching state set before the disabling function will be tracked. Any time functions still in progress will also be taken into account if necessary.</p> <p>Flash: The switching output is switched on and off cyclically after the disabling. The time for flashing is generally configured for all outputs on the parameter page "General -> General switching outputs". During flashing, the logical switching state of the output is fed back as "Switched on". The flashing state remains active until another KNX command is received and thereby predefines another switching state.</p>	

End of the disabling function after acknowledgement	no change to the switching state switch off switch on set tracked state flashing
<p>The behaviour of the switching output at the end of the disabling function after acknowledgement can be configured.</p> <p>This parameter is visible only if the disabling function is enabled and acknowledgement is used.</p> <p>no change of switching state: The relay of the output shows no reaction on acknowledgement and remains in the state last set by the disabling function.</p> <p>Switch off: On acknowledgement, the switching output is switched off and enabled again.</p> <p>Switch on: On acknowledgement, the switching output is switched on and enabled again.</p> <p>Set tracked state: On acknowledgement, the last switching state received during the disabling function or the switching state set before the disabling function will be tracked. Any time functions still in progress will also be taken into account if necessary.</p> <p>Flash: The switching output is switched on and off cyclically after the acknowledgement. The time for flashing is generally configured for all outputs on the parameter page "General -> General switching outputs". During flashing, the logical switching state of the output is fed back as "Switched on". The flashing state remains active until another KNX command is received and thereby predefines another switching state.</p>	

Relay output... -> SO... - General -> Forced position

Forced position "active, switch on"	switch on
<p>If the forced position is activated and restraint is "ON", the switching output is always switched on.</p> <p>This parameter cannot be edited and is only visible when the forced position function is enabled.</p>	
Forced position "active, switch off"	switch off
<p>If the forced position is activated and forced-position state is "OFF", the switching output is always switched off.</p> <p>This parameter cannot be edited and is only visible when the forced position function is enabled.</p>	

Forced position end "inactive"	tracking the switching state no change to the switching state switch off switch on
<p>The behaviour of the switching output at the end of the forced-position can be configured here.</p> <p>This parameter is only visible when the forced position function is enabled.</p> <p>Track switching state: The state received during the forced position function or the switching state set before the function can be tracked at the end of the forced position. Any time functions still in progress will also be taken into account if necessary.</p> <p>No change of switching state: The relay of the output shows no reaction and remains in the state last set by the forced position.</p> <p>Switch off: At the end of the forced position, the switching output is switched off and enabled again.</p> <p>Switch on: At the end of the forced position, the switching output is switched on and enabled again.</p>	
After bus voltage return	no forced position Forced position active, switch on Forced position active, switch off state before bus voltage failure
<p>The forced position communication object can be initialised after bus voltage return. The switching state of the output can be influenced when the forced position function is being activated.</p> <p>This parameter is only visible when the forced position function is enabled.</p> <p>No forced position: In case of bus voltage return, the force-independent parameter "After bus voltage return" (parameter page "Relay output... -> SO... - General") will be executed on return of bus voltage.</p> <p>Forced position active, switch on: The forced position is activated. The switching output is switched on under forced control.</p> <p>Forced position active, switch off: The forced position is activated. The switching output is switched off under forced control.</p> <p>State before bus voltage failure": The forced position state last selected and internally stored before bus voltage failure will be tracked after bus voltage return. An ETS programming operation deletes the stored state (reaction in that case same as with "no forced position active"). If the tracked state corresponds to "No forced position", the force-independent parameter "After bus voltage return" (parameter page "Relay output... -> SO... - General") will be executed on return of bus voltage.</p>	

11.10.2 Object list disabling function and forced position

Object no.	Function	Name	Type	DPT	Flag
330, 350...	Disabling	Switching... - Input	1-bit	1,003	C, (R), W, -, A
1-bit object for disabling a switching output (polarity configurable).					
Object no.	Function	Name	Type	DPT	Flag
331, 351...	Forced position	Switching... - Input	2-bit	2,001	C, (R), W, -, A
2-bit object for the forced position of a switching output. The polarity is fixed by the telegram.					
Object no.	Function	Name	Type	DPT	Flag
338, 358...	Disabling acknowledgment	Switching... - Input	1-bit	1,016	C, (R), W, -, A
1-bit object to acknowledge an active disabling function of a switching output. This object is only visible if the acknowledgement is to be used with the disabling function ("1" = Disabling function is deactivated / "0" = disabling function remains active).					

11.11 Logic operation function

A logic function can be configured separately for each switching output. This function allows the logic operation of the "Switching" object state and an additional logic operation object. The state of the communication object for "switching" can also be evaluated with a time delay if a switch-on delay or switch-off delay is set.

The logic function can also be combined with other functions of a switching output. A combination with the staircase function is not possible, however.

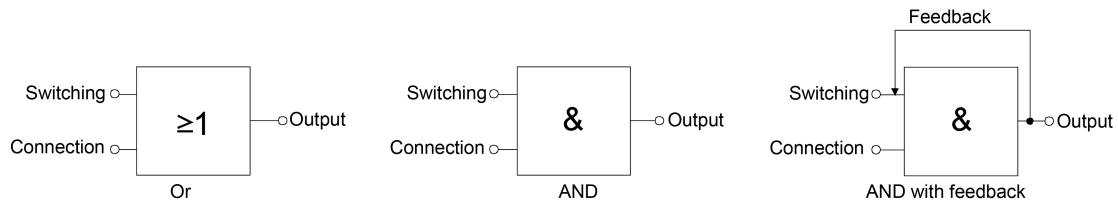

Image 29: Logic operation types of the logic operation function

i "AND with feedback":

With a logic object = "0", the switching output is always "0" (logic AND). In this case, the feedback signal from the output to the "switching" input will directly reset this input when it is being set. The output of the switching output can assume the logical state "1" by a newly received "1" on the input "switching" only when the logic object is = "1".

The object "Logic operation" can be initialised with a configured value after bus voltage return or after an ETS programming operation so that a correct logic operation result can be determined immediately and set on the output of the switching output during a telegram update on the "Switching" object.

- On the parameter page "Relay output... -> SO... - General -> Enabled functions" activate the "logic operation function".

The logic operation function is enabled. The communication object "logic operation" and the parameters of the logic operation function on the parameter page "Relay output... -> SO... - General -> Logic operation function" become visible.

- Set the parameter "Type of logic operation function" to the desired logic operation type.
- Set the parameters "object value after bus voltage return" and "object value after ETS programming" to the required initial states.

The "logic operation" object is initialised immediately with the set switching states after bus voltage return or ETS programming of the application program or parameters.

- i** The logic operation function after a reset of the actuator (bus voltage return or ETS programming operation) is first executed when the switching object is updated as the input of the logic operation by at least one telegram.

- i** The states or switching states specified at the end of a disabling function or forced position function, which are set after programming in the ETS, in the case of bus voltage failure or after bus or mains voltage return, override the lo-

gic operation function. The configured logic operation is first re-executed and the result set on the switching output when the switching object is updated as the input of the logic operation by at least one telegram.

11.11.1 Parameter logic operation function

Relay output... -> SO... - General -> Enabled functions

Logic operation function	Checkbox (yes / no)
<p>The logic operation function can be enabled here. The parameter is deactivated and unchangeable if the staircase function or cyclical monitoring is enabled.</p>	

Relay output... -> SO... - General -> Logic operation function

Type of logic operation function	OR AND AND with feedback
<p>This parameter defines the logical type of the logic operation function. The object "logic operation" is linked to the logic switching state of the switching output (object "switching" after evaluation of configured time delays if necessary) using the logic operation function set here. This parameter is only visible when the logic operation function is enabled.</p>	
Object value after bus voltage return	0 (OFF) 1 (ON)
<p>After bus voltage return, the object value of the logic operation object is initialised here with the preset value. This parameter is only visible when the logic operation function is enabled.</p>	
Object value after ETS download	0 (OFF) 1 (ON)
<p>After programming the application or the parameters in the ETS, the object value of the logic operation object is initialised here with the preset value. This parameter is only visible when the logic operation function is enabled.</p>	

11.11.2 Object list logic operation function

Object no.	Function	Name	Type	DPT	Flag
324, 344...	Logic operation	Switching... - Input	1-bit	1,002	C, (R), W, -, A

1-bit object as input of the logical link of an switching output. After bus voltage return or after programming with the ETS, the object value can be predefined for each parameter.

11.12 Operating hours counter

The operating hours counter determines the switch-on time of a switching output. For the operating hours counter, an output is actively on when the relay contact is closed, i.e. when current is flowing to the load. In consequence, a closed contact is always evaluated, irrespective of the set relay operating mode (NO or NC contact) and the logical feedback of the switching status.

The operating hours counter can either be configured as a second counter or alternatively as an hour counter.

- Second counter
The actuator adds up the determined switch-on time accurately to the second for a closed relay contact. The totalled operating seconds are added in a 4-byte counter and stored permanently in the device. The current counter reading can be transmitted cyclically to the KNX by the "Value operating hours counter reading" communication object or when there is a change in an interval value in acc. with DPT 13.100.
- Second counter
The actuator adds up the determined switch-on time accurately to the minute for a closed relay contact in full operating hours. The totalled operating hours are added in a 2-byte meter and stored permanently in the device. The current counter reading can be transmitted cyclically to the KNX by the "Value operating hours counter" communication object or when there is a change in an interval value in acc. with DPT 7.007.

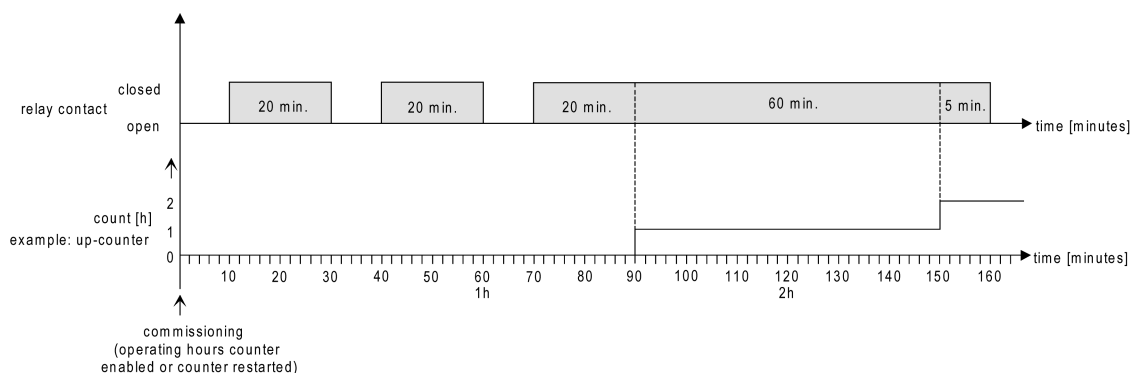

Image 30: Function of the operating hours counter (using the example of counted hours)

In the delivery state, all values of the actuator are "0". If the operating hours counter is not enabled in the configuration of an output, no operating hours or operating seconds will be counted for the output concerned. Once the operating hours counter is enabled in the ETS, however, the operating hours or operating seconds will be determined and added up by the ETS immediately after commissioning the actuator. If the operating hours counter is subsequently disabled again in the parameters and the actuator is programmed with this disabling function, all the operating hours or operating seconds previously counted for the output concerned will be deleted. When enabled again, the meter reading of the operating hours counter is always on "0 h".

The operating hours values (full hours) or operating seconds stored in the device will not be lost in case of a bus voltage failure or by ETS programming.

On the hour counter: Any summed up operating minutes (full hour not yet reached) will be rejected in this case, however.

After bus voltage return or after an ETS programming operation, the actuator passively updates the "Value operating hours counter" communication object in each output. The object value can be read out if the read-flag is set. The object value, depending on the configuration for the automatic transmission, is actively transmitted if necessary to the KNX once the configured transmission delay has elapsed after bus voltage return (see "Set transmission behaviour of the operating hours counter").

Activating the operating hours counter

- On the parameter page "Relay output... -> SO... - General -> Enabled functions" activate the parameter "operating hours counter".

The operating hours counter is activated.

- Deactivate the operating hours counter".

The operating hours counter is deactivated.

i Disabling of the operating hours counter and subsequent programming with the ETS resets the counter status to "0".

Setting the counter type

The operating hours counter can optionally be configured as an up-counter or down-counter. Depending on this type of counter, a limit or start value can be set optionally, whereby, for example, the operating time of a lamp can be monitored by restricting the counter range.

Up-counter:

After activating the operating hours counter by enabling in the ETS or by restarting, the operating hours are counted starting at "0". A maximum of 65,535 hours or 2147483647 can be counted (corresponds to approx. 66 years), after that the counter stops and signals a counter operation via the "Operating hours count. elapsed" object.

A limiting value can be set optionally in the ETS or can be predefined via the communication object "Limiting value operating hours counter". In this case, the counter operation is signaled to the KNX via the "Operating hours count. elapsed" object if the limiting value is reached, but the counter continues counting - if it is not restarted - up to the maximum value and then stops. Only a restart initiates a new counting operation.

Down-counter:

After enabling the operating hours counter in the ETS, the meter reading is on "0 h" and the actuator signals a counter operation for the output concerned after the programming operation or after bus voltage return via the "Operating hours count. elapsed" object. Only after a restart is the down-counter set to the maximum value of 65,535 hours or 2147483647 seconds (corresponds to approx. 66 years) and the counter operation is started.

A start value can be set optionally in the ETS or can be predefined via the communication object "start value operating hours counter". If a start value is set, the down-counter is initialised with this value instead of the maximum value after a restart. The meter then counts the start value downwards by the hour. When the down-counter reaches the value "0", the counter operation is signalled to the KNX via the "Operating hours count. elapsed" and the counting is stopped. Only a restart initiates a new counting operation.

The operating hours counter must be enabled on the parameter page "Relay output... -> SO... - General -> Enabled functions".

- Set the parameter "Counter type" on the parameter page "Relay output... -> SO... - General -> Operating hours counter" to "Up counter". Set the parameter "Limiting value presetting" to "yes, as specified in parameter" or "yes as received via object" if it is necessary to monitor the limiting value. Otherwise, reset the parameter to "no". In the "Yes, as specified in parameter" setting, specify the required limit value.

The meter counts the operating hours forwards starting from "0 h". If the monitoring of the limiting value is activated, the actuator transmits an "ON"-telegram via the object "Operating hours count. elapsed" for the output concerned once the predefined limiting value is reached. Otherwise, the counter operation is first transmitted when the maximum value is reached.

- Set the parameter "Counter type" to "Down-counter". Set the parameter "Start value preset" to "yes, as parameter" or "yes, as received via object" if a start value preset is necessary. Otherwise, reset the parameter to "no". In the "yes, as specified in parameter" setting, specify the required start value.

The meter counts the operating hours down to "0 h" after a restart. With a start value preset, the start value is counted down, otherwise the counting operation starts at the maximum value. The actuator transmits an "ON"-telegram via the object "Operating hours count. elapsed" for the output concerned once the value "0" is reached.

- i** The value of the communication object "Operating hours count. elapsed" is stored permanently. On switching on the bus voltage or after an ETS programming operation, the object is initialised with the most recently saved value. If an operating hours counter is in this case identified as elapsed, i.e. if the object value is a "ON", an additional telegram will be actively transmitted to the KNX as soon as the configured transmit delay has elapsed after bus voltage return. If the counter has not yet elapsed (object value (object value "OFF")), no telegram is transmitted on bus voltage return or after an ETS programming operation.
- i** With a limiting or start value preset via communication object: The values received via the object are first validly accepted and permanently saved internally after a restart of the operating hours counter. On switching on the bus voltage or after an ETS programming operation, the object is initialised with the most recently saved value. The values received will be lost in the case of a bus voltage failure or by an ETS programming operation if no counter restart was executed before. For this reason, when specifying a new start or limiting

value it is advisable to always execute a counter restart afterwards as well. A standard value of 65,535 hours or 2147483647 seconds is predefined provided that no limiting value or start value has been received yet via the object. The values received and stored via the object are reset to the standard value if the operating hours counter is disabled in the parameters of the ETS and an ETS programming operation is being performed.

- i** With a limiting or start value predefined via object: If the start or limiting value is predefined with "0", the actuator will ignore a counter restart to avoid an undesired reset (e.g. in site operation -> hours already counted by manual operation).
- i** If the counter direction of an operating hours counter is reversed by reconfiguration in the ETS, a restart of the meter should always be performed after programming the actuator so that the meter is reinitialised.

Restarting the operating hours counter

The meter reading of the operating hours can be reset at any time by the communication object "Restart operating hours counter". The polarity of the reset telegram is predefined: "1" = Restart / "0" = No reaction.

In the up-counter the meter is initialised with the value "0" after a restart and in the down-counter initialised with the start value. If no start value was configured or predefined by the object, the start value is preset to 65,535 hours or 2,147,483,647 seconds.

During every counter restart, the initialised meter reading is transmitted actively to the KNX.

After a restart, the signal of a counter operation is also reset. At the same time, an "OFF" telegram is transmitted to the KNX via the object "Operating hours count elapsed". In addition, the limiting or start value is initialised.

- i** If a new limiting or start value was predefined via the communication object, a counter restart should always be performed afterwards, too. Otherwise, the values received will be lost in the case of a bus voltage failure or by an ETS programming operation.
- i** If a start or limiting value is predefined with "0", there are different behaviours after a restart, depending on the principle of the value definition...
 - Preset as parameter:
The counter elapses immediately after a counter restart.
 - Preset via object:
A counter restart will be ignored to avoid an undesired reset (e.g. after installation of the devices with hours already being counted by manual operation). A limiting or start value greater than "0" must be predefined in order to perform the restart.

Setting the transmission behaviour

The current value of the operating hours counter is tracked continuously in the communication object "value operating hours counter". The content of the object is transmitted to the KNX when there is a change by the set count interval or cyclically active. The object value can also be read out at any time (set read flag).

The operating hours counter must be enabled on the parameter page "Relay output... -> SO... - General -> Enabled functions".

- Set the parameter "Automatic transmission of counter value" on parameter page "Relay output... -> SO... - General -> Operating hours counter" to "After change by interval value". Set the "Counting value interval" to the desired value.

The meter reading is transmitted to the KNX as soon as it changes by the pre-defined counting value interval. After bus voltage return or after ETS programming operation, the object value is transmitted automatically after "Delay after bus voltage return" has elapsed if the current counter status or a multiple of this corresponds to the counting value interval. A counter status "0" is always transmitted in this case.

- Set the parameter "Automatic transmission of counting value" to "Cyclical".
The counter value is transmitted cyclically. The cycle time is defined via the parameter of the same name. After bus voltage return or an ETS programming operation, the counter status is only transmitted to the KNX after the configured cycle time has elapsed.

11.12.1 Parameter Operating hours counter

Relay output... -> SO... - General -> Enabled functions

Operating hours counter	Checkbox (yes / no)
The operating hours counter can be disabled or enabled here.	

Relay output... -> SO... - General -> Operating hours counter

Function	second counter (DPT 13.100) hour counter (DPT 7.007)
----------	--

The operating hours counter can either be configured as a second counter or alternatively as an hour counter.

Second counter: The actuator adds up the determined switch-on time accurately to the second for a closed relay contact. The totaled operating seconds are added in a 4-byte counter and stored permanently in the device. The current counter reading can be transmitted cyclically to the KNX by the "Value operating hours counter reading" communication object or when there is a change in an interval value in acc. with DPT 13.100.

Hour counter: The actuator adds up the determined switch-on time accurately to the minute for a closed relay contact in full operating hours. The totaled operating hours are added in a 2-byte meter and stored permanently in the device. The current counter reading can be transmitted cyclically to the KNX by the "Value operating hours counter" communication object or when there is a change in an interval value in acc. with DPT 7.007.

Type of counter	up-counter down-counter
-----------------	-----------------------------------

The operating hours counter can be configured as an up-counter or down-counter. The setting here influences the visibility of the other parameters and objects of the operating hours counter.

Limiting value presetting	no yes, as specified in parameter yes, as received via object
---------------------------	--

If the up-counter is used, a limiting value can optionally be predefined. This parameter defines whether the limiting value can be set via a separate parameter or adapted individually by a communication object from the bus. The "No" setting deactivates the limiting value.

This parameter is only visible in the configuration "Type of counter = up-counter".

Limiting value (s)*	0...2147483647*
Limiting value (h)**	0...65535**
<p>The limiting value of the up-counter is set here. Once the limiting value is reached, an "ON" telegram is transmitted via the object "Operating hours count elapsed". The counter itself continues until the maximum counter status is reached and then stops.</p> <p>*: With second counter **: With hour counter</p> <p>This parameter is only visible if the parameter "Limiting value presetting" is set to "yes, as specified in parameter".</p>	
Start value preset	no yes, as specified in parameter yes, as received via object
<p>If the down-counter is used, a start value can optionally be predefined. This parameter defines whether the start value can be set via a separate parameter or adapted individually by a communication object from the bus. The setting "No" deactivates the start value.</p> <p>This parameter is only visible in the configuration "Type of counter = down-counter".</p>	
Start value (s)*	0...2147483647*
Start value (h)**	0...65535**
<p>The start value of the down-counter is set here. After the initialisation, the counter starts counting down the predefined value by the hour until the value "0". If this end value is reached, an "ON" telegram is transmitted via the object "Operating hours count elapsed"</p> <p>*: With seconds counter **: With hour counter</p> <p>This parameter is only visible if the parameter "Start value preset" is set to "yes, as specified in parameter".</p>	
Transmission behaviour of the counter value	cyclical after change by interval value
<p>The current meter reading of the operating hours counter can be transmitted actively to the KNX via the "value operating hours counter" communication object.</p> <p>Cyclically: The counter reading is transmitted cyclically to the KNX and when there is a change.</p> <p>After change by interval value: The counter reading is transmitted to the KNX only when there is a change.</p>	
Time for cyclical transmission hours (0...23)	0...23
<p>This parameter defines the cycle time for the cyclical transmission. Setting the cycle time hours.</p>	

Minutes (0...59)	0...15...59
Setting the cycle time minutes.	
Seconds (10...59)	10...59
Setting the cycle time seconds. This parameter for the cycle time is only visible when parameter "Transmission behaviour of the counter value" is set to "cyclically".	
Counter value interval	0...3600...2147483647* 0...1...65535**
The interval of the counter value is set here for automatic transmission. The current counter reading is transmitted to the KNX after the time interval configured here. *: With second counter **: With hour counter This parameter is only visible when parameter "Transmission behaviour of the counter value" is set to "On change by interval value".	

11.12.2 Object list operating hours counter

Object no.	Function	Name	Type	DPT	Flag
802, 809...	Limiting value / starting value, operating hours counter	Switching... - Input	4 bytes	13,100	C, (R), W, -, A
<p>4-byte object for external specification of a limit value / starting value of the operating hours counter of a switching output. Value range: 0...2,147,483,647 seconds This object is only available with the second counter.</p>					
Object no.	Function	Name	Type	DPT	Flag
803, 810...	Limiting value / starting value, operating hours counter	Switching... - Input	2 bytes	7,007	C, (R), W, -, A
<p>2-byte object for external specification of a limit value / starting value of the operating hours counter of a switching output. Value range: 0...65,535 hours This object is only available with the hour counter.</p>					
Object no.	Function	Name	Type	DPT	Flag
804, 811...	Restart op. hours counter	Switching... - Input	1-bit	1,015	C, (R), W, -, A
<p>1-bit object for resetting the operating hours counter of a switching output ("1" = restart, "0" = no reaction).</p>					
Object no.	Function	Name	Type	DPT	Flag
805, 812...	Value operating hours counter	Switching... - Output	4 bytes	13,100	C, R, -, T, A
<p>4-byte object to transmit or read out the current counter level of the operating hours counter of a switching output. Value range: 0...2,147,483,647 seconds If the bus voltage should fail, the value of the communication object is not lost and is actively transmitted to the bus after bus voltage return or an ETS programming operation. In the as-delivered state, the value is "0". This object is only available with the second counter.</p>					

Object no.	Function	Name	Type	DPT	Flag
806, 813...	Value operating hours counter	Switching... - Output	2 bytes	7,007	C, R, -, T, A

2-byte object to transmit or read out the current counter level of the operating hours counter of a switching output.

Value range: 0...65,535 hours

If the bus voltage should fail, the value of the communication object is not lost and is actively transmitted to the bus after bus voltage return or an ETS programming operation. In the as-delivered state, the value is "0".

This object is only available with the hour counter.

Object no.	Function	Name	Type	DPT	Flag
807, 814...	Op. hours counter elapsed	Switching... - Output	1-bit	1,002	C, R, -, T, A

1-bit object to sign that the operating hours counter has elapsed (forwards counter = limit value reached / backwards counter = value "0" reached). With a message, the object value is actively transmitted to the KNX ("1" = message active / "0" = message inactive).

If the bus voltage should fail, the value of the communication object is not lost and is actively transmitted to the bus after bus voltage return or an ETS programming operation.

12 Logic functions

The device contains up to 8 logic functions. Simple or complex logical operations in a KNX installation can be performed using these functions. Linking of input and output objects allows the networking of logic functions, permitting the execution of complex operations.

Enabling and configuring the number of logic functions

To be able to use logic functions, they must be enabled centrally on the "General" parameter page.

- Activate the parameter "Logic functions"

The logic functions can be used. The "Logic functions" parameter node becomes available, which contains additional parameter pages. The configuration of the logic functions takes place in this parameter node.

Logic functions can be enabled in steps so that the number of visible functions and, in consequence, the available parameters and communication objects are visible in the ETS. The number of available logic functions can be defined on the "Logic functions" parameter page

- Configure the "Number of logic functions" parameter to the desired value.
As many logic functions are created as have been selected.

i The application program deletes existing logic functions from the configuration if the number of available functions is reduced.

Up to two time functions can be preset for each switching output, independently of each other. The time functions affect the communication objects "Switching" and delay the object value received depending on the telegram polarity .

i At the end of a disabling function, the switching state received during the function or set before the function can be tracked. At the same time, residual times of time functions are also tracked if these had not yet fully elapsed at the time of the reactivation.

i The time delays do not influence the staircase function if this is enabled.

i A time delay still in progress will be fully aborted by a reset of the actuator (bus voltage failure or ETS programming).

12.1 Parameter logic functions

General

Logic functions	Checkbox (yes / no)
This parameter enables the logic functions globally. If the parameter is activated, the "Logic functions" parameter node becomes available, which contains additional parameter pages. The configuration of the logic functions takes place in this parameter node.	

Number of logic functions (1...8)	1...8
The number of required logic functions is defined here.	

Logic functions -> Logic function...

Name of logic function	Free text
The text entered in this parameter is applied to the name of the communication objects and is used to label the logic function in the ETS parameter window (e. g. "limit value switch outside temperature", disabling of Venetian blind garden door). The text is not programmed in the device.	

<p>Type of logic function</p>	<p>Logic gates Converter (1 bit -> 1 byte) Disabling element [Filtering/Time] Comparator Limit value switch with hysteresis</p>
<p>It is possible to be define which logical operation is to be executed for each logic function. This parameter is only visible if the logic functions have been enabled on the "General" parameter page.</p> <p>Logic gates: The logic function works as a Boolean logic gate with optionally 1 ... 4 inputs and one output.</p> <p>Converter (1 bit -> 1 byte): The logic function is configured as a converter. The converter has a 1-bit input and a 1-byte output and also a disabling object. ON / OFF telegrams can be converted to preconfigured values. The disabling object is able to deactivate the converter</p> <p>Disabling element (Filtering/Time): The logic function is configured as a disabling element. The disabling element has a 1-bit input and a 1-bit output. This logic function can delay input signals depending on the state (ON or OFF) and output them filtered at the output. A disabling object is also available, which can be used to deactivate the disabling element.</p> <p>Comparator: The logic function works as a comparator with an input whose data format can be parameterised, and with a 1-bit output to output the result of the comparison operation. The reference function and the reference value are configured in the ETS.</p> <p>Limit value switch with hysteresis: The logic function acts like a limit switch with hysteresis. An input with a configurable data format and a 1-bit output are available. The hysteresis is determined by an upper and lower threshold. The threshold values can be parameterised in the ETS. The input value is compared with the threshold values. The command at the output (ON / OFF) upon exceeding or falling below the configured threshold values can be configured.</p>	

12.2 Logic gates

A logic gate has up to 4 Boolean inputs (1 bit) and one logic output (1 bit). In consequence, a logic operation only supports the 1-bit data format. The following table shows configurable comparison operations Logic gate and explains their function.

Logic gates	Description	Icon
Invert (NOT)	The logic gate has only one input. The input is forwarded to the gate output inverted.	
AND (AND)	Logic gate has 4 inputs The output is "1" if all inputs are "1". Otherwise the output is "0".	
OR (OR)	Logic gate has 4 inputs The output is "0" if all inputs are "0". Otherwise the output is "1".	
Exclusive OR (XOR)	Logic gate has 4 inputs The output is "1" if only one input is "1". Otherwise the output is "0".	
inverted AND (NAND)	Logic gate has 4 inputs The output is "0" if all inputs are "1". Otherwise the output is "1".	
inverted OR (NOR)	Logic gate has 4 inputs The output is "1" if all inputs are "0". Otherwise the output is "0".	
inverted Exclusive OR (NXOR)	Logic gate has 4 inputs The output is "0" if only one input is "1". Otherwise the output is "1".	
AND with feedback (ANDR)	Logic gate has 4 inputs The output is fed back to the first input of the gate. The output is "1" if all inputs are "1". Otherwise the output is "0". If input 1 is set to "1" and the output is still "0", the feedback of input 1 is also reset to "0". Only when	

Logic gates	Description	Icon
	<p>inputs 2 ... 4 are "1" will a newly received "1" at input 1 cause the output to assume the logical state "1".</p> <p>Application: Switch light manually only at twilight -> Switch on input 1, twilight sensor on input 2 -> The manual switching signal is ignored for as long as the twilight sensor has not issued an enabling signal. The manual switching sign is only executed at twilight.</p>	

Inputs of a logic gate can be activated or deactivated separately. This allows gates with an individual number of inputs (1 ... 4) to be implemented. As an option, it is possible to invert inputs.

The transmission behaviour of the gate output can be configured.

12.2.1 Logic gate parameter

Logic functions -> Logic function...

Selection logic gate	Invert (NOT) AND (AND) OR (OR) Exclusive OR (XOR) inverted AND (NAND) inverted OR (NOR) inverted Exclusive OR (NXOR) AND with feedback (ANDR)
<p>This parameter defines the function of the logic gate and is only visible if "Type of logic function = logic gate".</p> <p>Invert (NOT): The inverter is configured. The gate has one input and one output. The Boolean data value of the input is forwarded to the output inverted.</p> <p>And (AND): An AND gate is configured. The gate has 1...4 inputs and one output. The inputs are logically AND-linked. The result is forwarded to the output.</p> <p>Or (OR): An OR gate is configured. The gate has 1...4 inputs and one output. The inputs are logically OR-linked. The result is forwarded to the output.</p> <p>Exclusive-OR (XOR): An exclusive-OR gate is configured. The gate has 1...4 inputs and one output. The inputs are logically Exclusive-OR-linked. The result is forwarded to the output.</p> <p>inverted And (NAND): An AND gate is configured. The gate has 1...4 inputs and one output. The inputs are logically AND-linked. The result is forwarded to the output inverted.</p> <p>inverted OR (NOR): An OR gate is configured. The gate has 1...4 inputs and one output. The inputs are logically OR-linked. The result is forwarded to the output inverted.</p> <p>Inverted Exclusive-OR (NXOR): An inverted Exclusive-OR gate is configured. The gate has 1...4 inputs and one output. The inputs are logically Exclusive-OR-linked. The result is forwarded to the output inverted.</p> <p>AND with feedback (ANDR): An AND gate with feedback is configured. The gate has 1...4 inputs and one output. The output is fed back to the first input of the gate.</p>	
Input 1	deactivated input object
<p>Inputs of a logic gate can be activated or deactivated separately. This allows gates with an individual number of inputs (1 ... 4) to be implemented. This parameter defines whether the first input of the gate should be used.</p> <p>This parameter is only visible if "Type of logic function = logic gate".</p>	

Input 2	deactivated input object
<p>Inputs of a logic gate can be activated or deactivated separately. This allows gates with an individual number of inputs (1 ... 4) to be implemented. This parameter defines whether the second input of the gate should be used.</p> <p>This parameter is only visible if "Type of logic function = logic gate".</p>	
Input 3	deactivated input object
<p>Inputs of a logic gate can be activated or deactivated separately. This allows gates with an individual number of inputs (1 ... 4) to be implemented. This parameter defines whether the third input of the gate should be used.</p> <p>This parameter is only visible if "Type of logic function = logic gate".</p>	
Input 4	deactivated input object
<p>Inputs of a logic gate can be activated or deactivated separately. This allows gates with an individual number of inputs (1 ... 4) to be implemented. This parameter defines whether the fourth input of the gate should be used.</p> <p>This parameter is only visible if "Type of logic function = logic gate".</p>	
Invert input	Checkbox (yes / no)
<p>It is possible to invert inputs of the logic gate as an option. This parameter is available for each input of the gate and defines whether the respective input should be evaluated unchanged or inverted.</p> <p>This parameter is only visible if "Type of logic function = logic gate".</p>	
Transmission criteria	always transmit when the input is updated send only if the output changes transmit cyclically
<p>The transmission behaviour of the output can be configured here.</p> <p>Always transmit when the input is updated: The output transmits the current object value to the KNX with every telegram that is received at the input.</p> <p>Transmit only if the output changes: The output only transmits the current object value if the object value has changed compared to the last transmission process. During the first telegram to an input after bus voltage return or after an ETS programming operation, the output always transmits to an input.</p> <p>transmit cyclically: With this setting, the output transmits the current object value to the KNX cyclically. The cyclical transmission is only started by the first valid trigger after the first telegram has been received at the input. The output also transmits as soon as a new telegram is received at the input. At the same time, the cycle time for cyclical sending is restarted!</p>	

Transmission delay for sending the result hours (0...99)	0...99
<p>An optional delay before result transmission (telegram at output) can be configured. With the setting "always transmit when the input is updated": Telegrams at the output are only transmitted after the trigger when the delay has elapsed. The delay time is restarted by each telegram at the input.</p> <p>With the setting "only transmit if the output changes": Telegrams are only sent when the object value changes at the output if the delay has expired. If the logic function is reprocessed by a new telegram at the input within the delay time and the object value changes again, then the delay restarts. If the object value of the output does not change due to new input telegrams, the delay does not restart.</p> <p>This parameter defines the hours of the delay time.</p>	
Minutes (0...59)	0...59
<p>This parameter defines the minutes of the delay time.</p>	
Seconds (0...59)	0...59
<p>This parameter defines the seconds of the delay time.</p> <p>The parameters for the transmission delay are only visible for "Transmission criteria" = "Always transmit when the input is updated" and "Only transmit when the output changes".</p>	
Cycle time hours (0...99)	0...99
<p>During cyclical transmission of the output, this parameter defines the cycle time. Setting the cycle time hours.</p>	
Minutes (0...59)	0...5...59
<p>This parameter defines the minutes of the cycle time.</p>	
Seconds (0...59)	0...59
<p>This parameter defines the seconds of the cycle time.</p> <p>The parameters for the cycle time are only visible if "transmission criteria" = "transmit cyclically".</p>	

12.2.2 Object list logic gate

Object no.	Function	Name	Type	DPT	Flag
970, 974, 978, 982, 986, 990, 994, 998	Logic gate... Input 1	Logic... - Input	1-bit	1,002	C, (R), W, -, A
<p>1-bit object as input 1 of a logic gate (1...8). The input status can be inverted optionally.</p> <p>This object is only available if the type of logic function is configured to "logic gate" and input 1 is used..</p>					

Object no.	Function	Name	Type	DPT	Flag
971, 975, 979, 983, 987, 991, 995, 999	Logic gate... Input 2	Logic... - Input	1-bit	1,002	C, (R), W, -, A
<p>1-bit object as input 2 of a logic gate (1...8). The input status can be inverted optionally.</p> <p>This object is only available if the type of logic function is configured to "logic gate" and input 2 is used..</p>					

Object no.	Function	Name	Type	DPT	Flag
972, 976, 980, 984, 988, 992, 996, 1000	Logic gate... Input 3	Logic... - Input	1-bit	1,002	C, (R), W, -, A
<p>1-bit object as input 3 of a logic gate (1...8). The input status can be inverted optionally.</p> <p>This object is only available if the type of logic function is configured to "logic gate" and input 3 is used..</p>					

Object no.	Function	Name	Type	DPT	Flag
973, 977, 981, 985, 989, 993, 997, 1001	Logic gate... Input 4	Logic... - Input	1-bit	1,002	C, (R), W, -, A
<p>1-bit object as input 4 of a logic gate (1...8). The input status can be inverted optionally.</p> <p>This object is only available if the type of logic function is configured to "logic gate" and input 4 is used..</p>					

Object no.	Function	Name	Type	DPT	Flag
1058, 1060, 1062, 1064, 1066, 1068, 1070, 1072	Logic gate output	Logic... - Output	1-bit	1,002	C, R, -, T, A
1-bit object as output of a logic gate (1...8). This object is only available if the type of logic function is configured to "logic gate".					

12.3 Converter (1 bit -> 1 byte)

The converter has a 1-bit input and a 1-byte output and also a disabling object. ON / OFF telegrams can be converted to preconfigured values. The disabling object is able to deactivate the converter

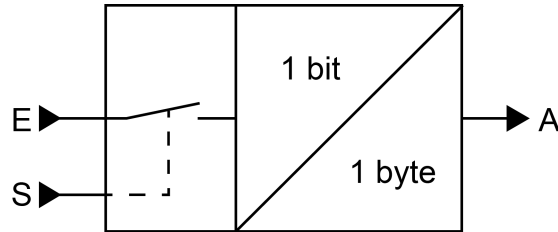

Image 31: Converter (1 bit -> 1 byte)

The converter can react differently to input states. The parameter "Reaction at input to" defines whether the converter responds to ON and OFF commands or alternatively only processes ON or OFF telegrams.

A concrete 1-byte output value can be assigned to each 1-bit input status. The two output values can be configured anywhere in the range 0 ... 255 as required. The data format of the converter output object is set to DPT 5.001 (0...100%).

The disabling object can be deactivated via the converter. A deactivated converter no longer processes input states and consequently does not convert any new output values (the last value is retained and transmitted cyclically, if necessary). At the end of a disabling function, the converter is enabled again. The converter then waits for the next telegram at the input.

The telegram polarity of the disabling object can be configured.

The transmission behaviour of the converter output can be configured.

12.3.1 Parameter converter

Logic functions -> Logic function...

Reaction at input to	ON and OFF telegrams ON telegrams OFF telegrams
<p>The converter can react differently to input states. It is defined here whether the converter responds to ON and OFF commands or alternatively only processes ON or OFF telegrams.</p>	
Polarity of the disabling object	0 = enabled / 1 = disabled 0 =disabled/ 1 = enabled
<p>This parameter defines the polarity of the disabling object.</p>	
Output value for ON (0...255)	0...255
<p>A concrete 1-byte output value can be assigned to each 1-bit input status. This parameter defines the output value for ON telegrams.</p> <p>This parameter is only visible when the input should react to ON telegrams.</p>	
Output value for OFF (0...255)	0...255
<p>A concrete 1-byte output value can be assigned to each 1-bit input status. This parameter defines the output value for OFF telegrams.</p> <p>This parameter is only visible when the input should react to OFF telegrams.</p>	
Transmission criteria	always transmit when the input is updated send only if the output changes transmit cyclically
<p>The transmission behaviour of the output can be configured here.</p> <p>Always transmit when the input is updated: The output transmits the current object value to the KNX with every telegram that is received at the input.</p> <p>Transmit only if the output changes: The output only transmits the current object value if the object value has changed compared to the last transmission process. During the first telegram to an input after bus voltage return or after an ETS programming operation, the output always transmits to an input.</p> <p>transmit cyclically: With this setting, the output transmits the current object value to the KNX cyclically. The cyclical transmission is only started by the first valid trigger after the first telegram has been received at the input. The output also transmits as soon as a new telegram is received at the input. At the same time, the cycle time for cyclical sending is restarted!</p>	

Transmission delay for sending the result hours (0...99)	0...99
<p>An optional delay before result transmission (telegram at output) can be configured. With the setting "always transmit when the input is updated": Telegrams at the output are only transmitted after the trigger when the delay has elapsed. The delay time is restarted by each telegram at the input.</p> <p>With the setting "only transmit if the output changes": Telegrams are only sent when the object value changes at the output if the delay has expired. If the logic function is reprocessed by a new telegram at the input within the delay time and the object value changes again, then the delay restarts. If the object value of the output does not change due to new input telegrams, the delay does not restart.</p> <p>This parameter defines the hours of the delay time.</p>	
Minutes (0...59)	0...59
<p>This parameter defines the minutes of the delay time.</p>	
Seconds (0...59)	0...59
<p>This parameter defines the seconds of the delay time.</p> <p>The parameters for the transmission delay are only visible for "Transmission criteria" = "Always transmit when the input is updated" and "Only transmit when the output changes".</p>	
Cycle time hours (0...99)	0...99
<p>During cyclical transmission of the output, this parameter defines the cycle time. Setting the cycle time hours.</p>	
Minutes (0...59)	0...5...59
<p>This parameter defines the minutes of the cycle time.</p>	
Seconds (0...59)	0...59
<p>This parameter defines the seconds of the cycle time.</p> <p>The parameters for the cycle time are only visible if "transmission criteria" = "transmit cyclically".</p>	

12.3.2 Object list converter

Object no.	Function	Name	Type	DPT	Flag
970, 974, 978, 982, 986, 990, 994, 998	Converter Input	Logic... - Input	1-bit	1,002	C, (R), W, -, A

1-bit object as input of a converter. It is possible to configure whether the converter responds to ON and OFF commands or alternatively only processes ON or OFF telegrams.

This object is only available if the type of logic function is configured to "converter".

Object no.	Function	Name	Type	DPT	Flag
971, 975, 979, 983, 987, 991, 995, 999	Converter Disabling function	Logic... - Input	1-bit	1,002	C, (R), W, -, A

1-bit object as disabling input of a converter. A disabled converter no longer processes input states and consequently does not convert any new output values (the last value is retained and transmitted cyclically, if necessary).

The telegram polarity can be configured.

This object is only available if the type of logic function is configured to "converter".

Object no.	Function	Name	Type	DPT	Flag
1106, 1107, 1108, 1109, 1110, 1111, 1112, 1113	Converter Output	Logic... - Output	1 bytes	5,001	C, R, -, T, A

1-byte object as value output of a converter.

This object is only available if the type of logic function is configured to "converter".

12.4 Disabling element [Filtering/Time]

The disabling element has a 1-bit input and a 1-bit output as well as a disabling object. Input states (ON/OFF) can be delayed independently of one another and filtered at the output before output. The filter makes it possible to invert the states of the output (e.g. ON -> OFF) or to suppress it completely (e.g. OFF -> ---, OFF is not transmitted). If the filter is not used, the disabling element only works with the time functions if required. Alternatively, it is possible to use only the filter (without delays).

The disabling object is able to deactivate the disabling element.

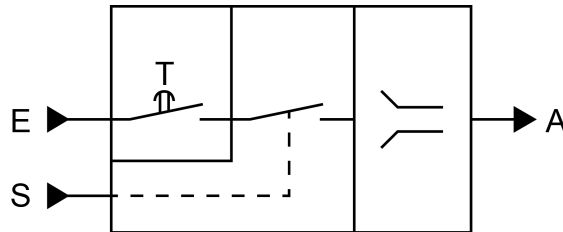

Image 32: Disabling element [Filtering/Time]

The parameter "Time function" defines whether ON or OFF telegrams or both states are evaluated with a delay after reception at the input. If a delay is provided, the delay time can be configured separately for ON and OFF telegrams. A delay is only effective if the delay time is set to greater than "0". Each telegram received at the input re-triggers the receptive delay time.

If no delay is configured, the input telegrams go directly into the filter.

i Special feature when using the delays: If no telegram is received at the input, a configured delay time (time > 0) acts like an automatic cyclic trigger of the filter. The most recently received input status is then forwarded to the filter automatically and repeatedly after the delay has elapsed. This then works according to its configuration and forwards the result to the output of the disabling element. Consequently, the output then also transmits telegrams depending on the transmission criteria set. If the cyclical transmission of the output is not desired due to the automatic triggering of the filter, the transmission criterion should be set to "only transmit if the output changes".

If no delay is provided, the filter is only triggered automatically via the received telegrams and thus not automatically.

i After bus voltage return or after an ETS programming operation, the delays are triggered automatically.

The filter is set by the parameter "Filter function" according to the following table.

Filter function	Result
ON -> OFF / OFF -> OFF	Input telegrams are forwarded to the output unchanged. Filter deactivated.
ON -> --- / OFF -> OFF	ON telegrams are filtered and not forwarded to the output. OFF telegrams are forwarded to the output unchanged.

Filter function	Result
ON -> ON / OFF -> ---	OFF telegrams are filtered and not forwarded to the output. ON telegrams are forwarded to the output unchanged.
ON -> OFF / OFF -> ON	ON telegrams are converted to OFF telegrams and OFF telegrams are converted to ON telegrams and are forwarded to the output.
ON -> --- / OFF -> ON	ON telegrams are filtered and not forwarded to the output. OFF telegrams are converted to ON telegrams and forwarded to the output.
ON -> OFF / OFF -> ---	OFF telegrams are filtered and not forwarded to the output. ON telegrams are converted to OFF telegrams and forwarded to the output.

The disabling element can be deactivated by the disabling object. A deactivated disabling element no longer forwards any input states to the filter and consequently does not convert any new output values (the last value is retained and transmitted cyclically, if necessary). However, the input states are still evaluated (even with effective delays). At the end of a disabling function, the disabling element is enabled again. The disabling element waits for the next telegram at the input or for the next cycle of the configured delay times.

The telegram polarity of the disabling object can be configured.

The transmission behaviour of the disabling element output can be configured.

12.4.1 Parameter disabling element

Logic functions -> Logic function...

Time function	no delay only delay ON telegrams only delay OFF telegrams delay ON and OFF telegrams
This parameter defines whether ON or OFF telegrams or both states are evaluated with a delay after reception at the input. If a delay is provided, the delay time can be configured separately for ON and OFF telegrams. If no delay is configured, the input telegrams go directly into the filter.	
Delay for ON telegrams Minutes (0...59)	0...59
<p>The delay for ON telegrams is configured here. A delay is only effective if the delay time is set to greater than "0". Each ON telegram received at the input re-triggers the delay time.</p> <p>Special feature when using the delays: If no telegram is received at the input, a configured delay time (time > 0) acts like an automatic cyclic trigger of the filter. The most recently received input status is then forwarded to the filter automatically and repeatedly after the delay has elapsed. This then works according to its configuration and forwards the result to the output of the disabling element. Consequently, the output then also transmits telegrams depending on the transmission criteria set. If the cyclical transmission of the output is not desired due to the automatic triggering of the filter, the transmission criterion should be set to "only transmit if the output changes".</p> <p>After bus voltage return or after an ETS programming operation, the delays are triggered automatically.</p> <p>Setting the ON delay time minutes.</p>	
Seconds (0...59)	0...10...59
Setting the seconds of the ON delay time. The parameters for the ON delay are only available if the parameter "Time function" is set to "only delay ON telegrams" or "delay ON and OFF telegrams".	

Delay for OFF telegrams Minutes (0...59)	0...59
<p>The delay for OFF telegrams is configured here. A delay is only effective if the delay time is set to greater than "0". Each OFF telegram received at the input re-triggers the delay time.</p> <p>Special feature when using the delays: If no telegram is received at the input, a configured delay time (time > 0) acts like an automatic cyclic trigger of the filter. The most recently received input status is then forwarded to the filter automatically and repeatedly after the delay has elapsed. This then works according to its configuration and forwards the result to the output of the disabling element. Consequently, the output then also transmits telegrams depending on the transmission criteria set. If the cyclical transmission of the output is not desired due to the automatic triggering of the filter, the transmission criterion should be set to "only transmit if the output changes".</p> <p>After bus voltage return or after an ETS programming operation, the delays are triggered automatically.</p> <p>Setting the OFF delay time minutes.</p>	
Seconds (0...59)	0...10...59
<p>Setting the OFF delay time seconds.</p> <p>The parameters for the OFF delay are only available if the parameter "Time function" is set to "only delay OFF telegrams" or "delay ON and OFF telegrams".</p>	
Polarity of the disabling object	0 = enabled / 1 = disabled 0 =disabled/ 1 = enabled
<p>This parameter defines the polarity of the disabling object.</p>	

Filter function	ON -> OFF / OFF -> OFF ON -> --- / OFF -> OFF ON -> ON / OFF -> --- ON -> OFF / OFF -> ON ON -> --- / OFF -> ON ON -> OFF / OFF -> ---
-----------------	---

This parameter defines the function of the filter.

ON -> ON / OFF -> OFF: Input telegrams are forwarded to the output unchanged. Filter deactivated.

ON -> --- / OFF -> OFF: ON telegrams are filtered and not forwarded to the output. OFF telegrams are forwarded to the output unchanged.

ON -> ON / OFF -> ---: OFF telegrams are filtered and not forwarded to the output. ON telegrams are forwarded to the output unchanged.

ON -> OFF / OFF -> ON: ON telegrams are converted to OFF telegrams and OFF telegrams are converted to ON telegrams and forwarded to the output.

ON -> --- / OFF -> ON: ON telegrams are filtered and not forwarded to the output. OFF telegrams are converted to ON telegrams and forwarded to the output.

ON -> OFF / OFF -> ---: OFF telegrams are filtered and not forwarded to the output. ON telegrams are converted to OFF telegrams and forwarded to the output.

Transmission criteria	always transmit when the input is updated send only if the output changes transmit cyclically
-----------------------	---

The transmission behaviour of the output can be configured here.

Always transmit when the input is updated: The output transmits the current object value to the KNX with every telegram that is received at the input. In addition, transmission at the output is repeated if no telegram was received at the input when the delay times were used and the configured time has expired.

Transmit only if the output changes: The output only transmits the current object value if the object value has changed compared to the last transmission process. After bus voltage return or an ETS programming operation, the output always transmits.

transmit cyclically: With this setting, the output transmits the current object value to the KNX cyclically. The cyclical transmission is only started by the first valid trigger after the first telegram has been received at the input. If the ON / OFF delay is used, after bus voltage return or after an ETS programming, operation cyclical transmission starts automatically once the delay time has expired. The output also transmits as soon as a new telegram is received at the input. At the same time, the cycle time for cyclical sending is restarted!

Cycle time hours (0...99)	0...99
---------------------------	--------

During cyclical transmission of the output, this parameter defines the cycle time. Setting the cycle time hours.

Minutes (0...59)	0...5...59
This parameter defines the minutes of the cycle time.	
Seconds (0...59)	0...59
This parameter defines the seconds of the cycle time. The parameters for the cycle time are only visible if "transmission criteria" = "transmit cyclically".	

12.4.2 Object list disabling element

Object no.	Function	Name	Type	DPT	Flag
970, 974, 978, 982, 986, 990, 994, 998	Disabling element Input	Logic... - Input	1-bit	1,002	C, (R), W, -, A
<p>1-bit object as input of a disabling element.</p> <p>This object is only available if the type of logic function is configured to "disabling element".</p>					

Object no.	Function	Name	Type	DPT	Flag
971, 975, 979, 983, 987, 991, 995, 999	Disabling element Disabling function	Logic... - Input	1-bit	1,002	C, (R), W, -, A
<p>1-bit object as disabling input of a disabling element. A disabled disabling element no longer forwards any input states to the filter and consequently does not convert any new output values (the last value is retained and transmitted cyclically, if necessary).</p> <p>The telegram polarity can be configured.</p> <p>This object is only available if the type of logic function is configured to "disabling element".</p>					

Object no.	Function	Name	Type	DPT	Flag
1058, 1060, 1062, 1064, 1066, 1068, 1070, 1072	Disabling element Output	Logic... - Output	1-bit	1,002	C, R, -, T, A
<p>1-bit object as output of a disabling element.</p> <p>This object is only available if the type of logic function is configured to "disabling element".</p>					

12.5 Comparator

The comparator works with an input whose data format can be parameterised, and with a 1-bit output to output the result of the comparison operation. The comparator compares the value received at the input with a configured reference value and evaluates whether the reference is correct (result = true) or not (result = false) according to the specified reference function.

The reference function and the reference value are configured in the ETS.

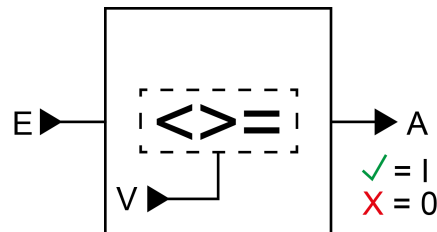

Image 33: Comparator

The parameter "data format" defines the size and format of input object according to the following table. The output object is preset to 1-bit (DPT 1.002) and outputs the result of the comparison operation (ON = true / OFF = false). The reference value that can be set in the ETS adapts to the input data format.

Data format	KNX DPT
4-bit dimming	3,007
1-byte operating mode switchover	20,102
1- byte scene extension	18,001
1-byte value 0...255	5,010
1-byte brightness value 0...100%	5,001
2-byte value 0...65535	7,001
2-byte value -32768...32767	8,001
2-byte floating-point number	9.0xx
4-byte value -2147483648...2147483647	13,001

The following table shows the possible reference functions (I = input value, R = reference value).

Reference function	Function
equal (I = R)	The comparator output is "ON" (true) if the input is equal to the reference value. Otherwise the output is "OFF" (false).
unequal (I ≠ R)	The comparator output is "ON" (true) if the input is unequal to the reference value. If the input value is equal to the reference value, the output is "OFF" (false).
greater than (I > R)	The comparator output is "ON" (true) if the input is greater than the reference value. If the input value is less than or equal to the reference value, the output switches "OFF" (false).

Reference function	Function
greater than or equal to ($I \geq R$)	The comparator output is "ON" (true) if the input is greater than the reference value or equal to the reference value. If the input value is less than the reference value, the output switches "OFF" (false).
less than ($I < R$)	The comparator output is "ON" (true) if the input is less than the reference value. If the input value is greater than or equal to the reference value, the output switches "OFF" (false).
less than or equal to ($I \leq R$)	The comparator output is "ON" (true) if the input is less than the reference value or equal to the reference value. If the input value is greater than the reference value, the output switches "OFF" (false).
range testing less than ($R1 < I < R2$)	There are two reference values. The comparator output is "ON" (true) if the input is greater than the first reference value or less than the second reference value. If the input value is less than the first reference value or equal to the first reference value or greater than the second reference value or equal to the second reference value, the output switches "OFF" (wrong).
range testing less than or equal to ($R1 \leq I \leq R2$)	There are two reference values. The comparator output is "ON" (true) if the input is greater than or equal to the first reference value and less than or equal to the second reference value, the output switches "OFF" (false). If the input value is less than the first reference value or greater than the second reference value, the output switches "OFF" (false).

The transmission behaviour of the comparator output can be configured.

12.5.1 Parameter Comparator

Logic functions -> Logic function...

Data format	4-bit dimming (DPT 3.007) 1-byte operating mode switchover (DPT 20.102) 1-byte scene extension (DPT 18.001) 1-byte value 0...255 (DPT 5.010) 1-byte brightness value 0...100 % (DPT 5.001) 2-byte value 0...65535 (DPT 7.001) 2-byte value -32768...32767 (DPT 8.001) 2-byte floating-point number (DPT 9.0xx) 4-byte value -2147483648...2147483647 (DPT 13.001)
<p>This parameter defines the size and format of input object. The output object is pre-set to 1-bit (DPT 1.002) and outputs the result of the comparison operation (ON = true / OFF = false).</p>	

Reference function	<p>equal ($E = V$)</p> <p>unequal ($E \neq V$)</p> <p>greater than ($E > V$)</p> <p>greater than or equal to ($E \geq V$)</p> <p>less than ($E < V$)</p> <p>less than or equal to ($E \leq V$)</p> <p>range testing less than ($V1 < E < V2$)</p> <p>range testing smaller than or equal to ($V1 \leq E \leq V2$)</p>
<p>The comparator compares the value received (I) at the input with a configured reference value (R) and evaluates whether the comparison is correct (result = true) or not (result = false) according to the specified reference function here.</p> <p>equal ($I = R$): The comparator output is "ON" (true) if the input is equal to the reference value. Otherwise the output is "OFF" (false).</p> <p>unequal ($I \neq R$): The comparator output is "ON" (true) if the input is unequal to the reference value. If the input value is equal to the reference value, the output is "OFF" (false).</p> <p>greater ($I > R$): The comparator output is "ON" (true) if the input is greater than the reference value. If the input value is less than or equal to the reference value, the output switches "OFF" (false).</p> <p>greater than or equal to ($I \geq R$): The comparator output is "ON" (true) if the input is greater than the reference value or equal to the reference value. If the input value is less than the reference value, the output switches "OFF" (false).</p> <p>less than ($I < R$): The comparator output is "ON" (true) if the input is less than the reference value. If the input value is greater than or equal to the reference value, the output switches "OFF" (false).</p> <p>less than or equal to ($I \leq R$): The comparator output is "ON" (true) if the input is less than the reference value or equal to the reference value. If the input value is greater than the reference value, the output switches "OFF" (false).</p> <p>Range testing less than ($R1 < I < R2$): There are two reference values. The comparator output is "ON" (true) if the input is greater than the first reference value or less than the second reference value. If the input value is less than the first reference value or equal to the first reference value or greater than the second reference value or equal to the second reference value, the output switches "OFF" (wrong).</p> <p>Range testing less than or equal to ($R1 \leq I \leq R2$): There are two reference values. The comparator output is "ON" (true) if the input is greater than or equal to the first reference value and less than or equal to the second reference value, the output switches "OFF" (false). If the input value is less than the first reference value or greater than the second reference value, the output switches "OFF" (false).</p>	

Reference value (V)	<p>dimming darker, stop (0)</p> <p>dimming darker, 100 % (1)</p> <p>dimming darker, 50 % (2)</p> <p>dimming darker, 25 % (3)</p> <p>dimming darker, 12.5 % (4)</p> <p>dimming darker, 6 % (5)</p> <p>dimming darker, 3 % (6)</p> <p>dimming darker, 1.5 % (7)</p> <p>increase brightness, stop (8)</p> <p>increase brightness, 100 % (9)</p> <p>increase brightness, 50 % (10)</p> <p>increase brightness, 25 % (11)</p> <p>increase brightness, 12.5 % (12)</p> <p>increase brightness, 6 % (13)</p> <p>increase brightness, 3 % (14)</p> <p>increase brightness, 1.5 % (15)</p>
---------------------	--

This parameter specifies the internal reference value (R) for the reference function.
 This parameter is only available if the "data format" is set to "4-bit dimming (DPT 3.007)".

Reference value (V)	<p>automatic (0)</p> <p>comfort mode (1)</p> <p>standby mode (2)</p> <p>night operation (3)</p> <p>frost/heat protection (4)</p>
---------------------	---

This parameter specifies the internal reference value (R) for the reference function.
 This parameter is only available if the "data format" is set to "1 byte operating mode switchover (DPT 20.102)".

Reference value (V)	<p>recall scene 1 (0)</p> <p>recall scene 2 (1)</p> <p>...</p> <p>recall scene 64 (63)</p> <p>save scene 1 (128)</p> <p>save scene 2 (129)</p> <p>...</p> <p>save scene 64 (191)</p>
---------------------	---

This parameter specifies the internal reference value (R) for the reference function.
 This parameter is only available if the "data format" is set to "1 byte scene extension (DPT 18.001)".

Reference value (V) (0...255)	0...255
This parameter specifies the internal reference value (R) for the reference function. This parameter is only available if the "data format" is set to "1 byte value -0...255 (DPT 5.010)".	
Reference value (V) (0...100%)	0...100
This parameter specifies the internal reference value (R) for the reference function. This parameter is only available if the "data format" is set to "1 byte brightness value 0...100 % (DPT 5.001)".	
Reference value (V) (0...65535)	0...65535
This parameter specifies the internal reference value (R) for the reference function. This parameter is only available if the "data format" is set to "2 byte value 0...65535 (DPT 7.001)".	
Reference value (V) (-32768...32767)	-32768...0...32767
This parameter specifies the internal reference value (R) for the reference function. This parameter is only available if the "data format" is set to "2 byte value 32768...32767 (DPT 8.001)".	
Reference value (V) (-671088...670760)	-671088...0...670760
This parameter specifies the internal reference value (R) for the reference function. This parameter is only available if the "data format" is set to "2 byte floating point value (DPT 9.0xx)".	
Reference value (V) (-2147483648...2147483647)	-2147483648...0...2147483647
This parameter specifies the internal reference value (R) for the reference function. This parameter is only available if the "data format" is set to "4 byte value -2147483648...2147483647 (DPT 13.001)".	

- i** Two reference values (R1 & R2) can be configured if the range testing is configured as "reference function". In this case, the setting options are identical.

Transmission criteria	<p>always transmit when the input is updated send only if the output changes transmit cyclically</p>
<p>The transmission behaviour of the output can be configured here.</p> <p>Always transmit when the input is updated: The output transmits the current object value to the KNX with every telegram that is received at the input.</p> <p>Transmit only if the output changes: The output only transmits the current object value if the object value has changed compared to the last transmission process. During the first telegram to an input after bus voltage return or after an ETS programming operation, the output always transmits to an input.</p> <p>transmit cyclically: With this setting, the output transmits the current object value to the KNX cyclically. The cyclical transmission is only started by the first valid trigger after the first telegram has been received at the input. The output also transmits as soon as a new telegram is received at the input. At the same time, the cycle time for cyclical sending is restarted!</p>	
Transmission delay for sending the result hours (0...99)	0...99
<p>An optional delay before result transmission (telegram at output) can be configured.</p> <p>With the setting "always transmit when the input is updated": Telegrams at the output are only transmitted after the trigger when the delay has elapsed. The delay time is restarted by each telegram at the input.</p> <p>With the setting "only transmit if the output changes": Telegrams are only sent when the object value changes at the output if the delay has expired. If the logic function is reprocessed by a new telegram at the input within the delay time and the object value changes again, then the delay restarts. If the object value of the output does not change due to new input telegrams, the delay does not restart.</p> <p>This parameter defines the hours of the delay time.</p>	
Minutes (0...59)	0...59
<p>This parameter defines the minutes of the delay time.</p>	
Seconds (0...59)	0...59
<p>This parameter defines the seconds of the delay time.</p> <p>The parameters for the transmission delay are only visible for "Transmission criteria" = "Always transmit when the input is updated" and "Only transmit when the output changes".</p>	
Cycle time hours (0...99)	0...99
<p>During cyclical transmission of the output, this parameter defines the cycle time.</p> <p>Setting the cycle time hours.</p>	
Minutes (0...59)	0... 5 ...59
<p>This parameter defines the minutes of the cycle time.</p>	

Seconds (0...59)	0...59
This parameter defines the seconds of the cycle time. The parameters for the cycle time are only visible if "transmission criteria" = "transmit cyclically".	

12.5.2 Object list comparator

Object no.	Function	Name	Type	DPT	Flag
1002, 1003, 1004, 1005, 1006, 1007, 1008, 1009	Comparator Input	Logic... - Input	4-bit	3,007	C, (R), W, -, A

4-bit object as input of a comparator.

This object is only available if the type of logic function is configured to "comparator" and the data format is configured to "4-bit dimming (DPT 3.007)".

Object no.	Function	Name	Type	DPT	Flag
1018, 1019, 1020, 1021, 1022, 1023, 1024, 1025	Comparator Input	Logic... - Input	1 bytes	20,102	C, (R), W, -, A

1-byte object as input of a comparator.

This object is only available if the type of logic function is configured to "comparator" and the data format is configured to "1 byte operating mode switchover (DPT 20.102)".

Object no.	Function	Name	Type	DPT	Flag
1018, 1019, 1020, 1021, 1022, 1023, 1024, 1025	Comparator Input	Logic... - Input	1 bytes	18,001	C, (R), W, -, A

1-byte object as input of a comparator.

This object is only available if the type of logic function is configured to "comparator" and the data format is configured to "1 byte scene extension (DPT 18.001)".

Object no.	Function	Name	Type	DPT	Flag
1018, 1019, 1020, 1021, 1022, 1023, 1024, 1025	Comparator Input	Logic... - Input	1 bytes	5,010	C, (R), W, -, A

1-byte object as input of a comparator.

This object is only available if the type of logic function is configured to "comparator" and the data format is configured to "1-byte value 0...255 (DPT 5.010)".

Object no.	Function	Name	Type	DPT	Flag
1018, 1019, 1020, 1021, 1022, 1023, 1024, 1025	Comparator Input	Logic... - Input	1 bytes	5,001	C, (R), W, -, A

1-byte object as input of a comparator.

This object is only available if the type of logic function is configured to "comparator" and the data format is configured to "1-byte brightness value 0...100 % (DPT 5.001)".

Object no.	Function	Name	Type	DPT	Flag
1034, 1035, 1036, 1037, 1038, 1039, 1040, 1041	Comparator Input	Logic... - Input	2 bytes	7,001	C, (R), W, -, A

2-byte object as input of a comparator.

This object is only available if the type of logic function is configured to "comparator" and the data format is configured to "2-byte value 0...65535 (DPT 7.001)".

Object no.	Function	Name	Type	DPT	Flag
1034, 1035, 1036, 1037, 1038, 1039, 1040, 1041	Comparator Input	Logic... - Input	2 bytes	8,001	C, (R), W, -, A

2-byte object as input of a comparator.

This object is only available if the type of logic function is configured to "comparator" and the data format is configured to "2-byte value -32768...32767 (DPT 8.001)".

Object no.	Function	Name	Type	DPT	Flag
1034, 1035, 1036, 1037, 1038, 1039, 1040, 1041	Comparator Input	Logic... - Input	2 bytes	9.xxx	C, (R), W, -, A

2-byte object as input of a comparator.

This object is only available if the type of logic function is configured to "comparator" and the data format is configured to "2-byte floating point value (DPT 9.0xx)".

Object no.	Function	Name	Type	DPT	Flag
1050, 1051, 1052, 1053, 1054, 1055, 1056, 1057	Comparator Input	Logic... - Input	4 bytes	13,001	C, (R), W, -, A

4-byte object as input of a comparator.

This object is only available if the type of logic function is configured to "comparator" and the data format is configured to "4-byte value -2147483648...2147483647 (DPT 13.001)".

Object no.	Function	Name	Type	DPT	Flag
1058, 1060, 1062, 1064, 1066, 1068, 1070, 1072	Comparator Output	Logic... - Output	1-bit	1,002	C, R, -, T, A
1-bit object as output of a comparator. The output object is preset to 1-bit (DPT 1.002) and outputs the result of the comparison operation (ON = true / OFF = false). This object is only available if the type of logic function is configured to "comparator".					

12.6 Limit value switch

The limit value switch works with an input whose data format can be configured, and with a 1-bit output to output the result of the threshold evaluation. The limit value switch compares the value received at the input with two configurable hysteresis threshold values. Once the upper threshold value (H2) is reached or exceeded, the output can transmit a switching telegram (e.g. ON = true). If the value falls below the lower threshold value (H1), the output can transmit another switching telegram (e.g. OFF = false).

The switching telegrams can always be configured in the ETS when the threshold values are exceeded and undershot.

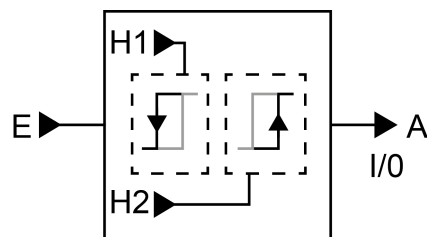

Image 34: Limit value switch

The two threshold values define a hysteresis. The hysteresis prevents frequent switching back and forth of the output, provided that the input value changes continuously in small intervals. Only when the change in value at the input exceeds the hysteresis as a whole, does the output switch the status.

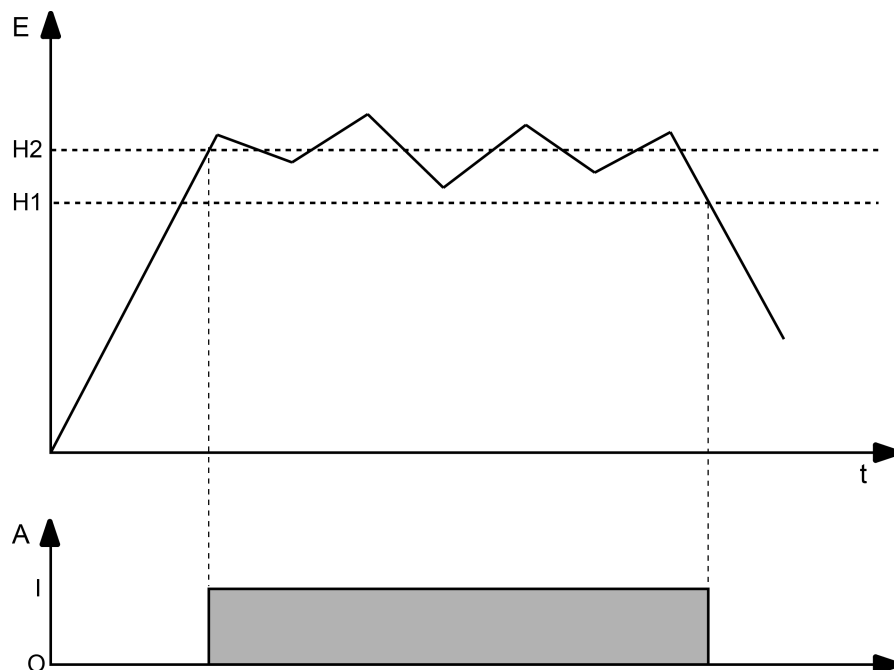

Image 35: Example of a hysteresis evaluation by upper and lower threshold value.

- i** The two threshold values can be freely configured in the ETS. Make sure that the upper threshold value is greater than the lower one!

- i** After bus voltage return or after an ETS programming operation, the output always transmits a telegram when the first value has been received at the input. The telegram depends on whether the value reaches or exceeds the upper threshold (H2) or not. If the value is less than the upper threshold, a telegram is transmitted in accordance with "Telegram upon not reaching the lower threshold". Otherwise the output transmits the "telegram on exceeding the upper threshold value".

The parameter "data format" defines the size and format of input object according to the following table. The output object is preset to 1-bit (DPT 1.002) and outputs the result of the threshold evaluation (ON = true / OFF = false). The threshold values that can be set in the ETS adapt to the input data format.

Data format	KNX DPT
4-bit dimming	3,007
1-byte operating mode switchover	20,102
1- byte scene extension	18,001
1-byte value 0...255	5,010
1-byte brightness value 0...100%	5,001
2-byte value 0...65535	7,001
2-byte value -32768...32767	8,001
2-byte floating-point number	9.0xx
4-byte value -2147483648...2147483647	13,001

The transmission behaviour of the limit value switch can be configured.

12.6.1 Parameter limit value switch

Logic functions -> Logic function...

Data format	4-bit dimming (DPT 3.007) 1-byte operating mode switchover (DPT 20.102) 1-byte scene extension (DPT 18.001) 1-byte value 0...255 (DPT 5.010) 1-byte brightness value 0...100 % (DPT 5.001) 2-byte value 0...65535 (DPT 7.001) 2-byte value -32768...32767 (DPT 8.001) 2-byte floating-point number (DPT 9.0xx) 4-byte value -2147483648...2147483647 (DPT 13.001)
This parameter defines the size and format of input object. The output object is preset to 1-bit (DPT 1.002) and outputs the result of the threshold evaluation (ON = true / OFF = false).	
Lower threshold value (H1)	dimming darker, stop (0) dimming darker, 100 % (1) dimming darker, 50 % (2) dimming darker, 25 % (3) dimming darker, 12.5 % (4) dimming darker, 6 % (5) dimming darker, 3 % (6) dimming darker, 1.5 % (7) increase brightness, stop (8) increase brightness, 100 % (9) increase brightness, 50 % (10) increase brightness, 25 % (11) increase brightness, 12.5 % (12) increase brightness, 6 % (13) increase brightness, 3 % (14) increase brightness, 1.5 % (15)
This parameter defines the lower threshold value (H1) of the limit value switch. This parameter is only available if the "data format" is set to "4-bit dimming (DPT 3.007)".	

Lower threshold value (H1)	automatic (0) comfort mode (1) standby mode (2) night operation (3) frost/heat protection (4)
This parameter defines the lower threshold value (H1) of the limit value switch. This parameter is only available if the "data format" is set to "1 byte operating mode switchover (DPT 20.102)".	
Lower threshold value (H1)	recall scene 1 (0) recall scene 2 (1) ... recall scene 64 (63) save scene 1 (128) save scene 2 (129) ... save scene 64 (191)
This parameter defines the lower threshold value (H1) of the limit value switch. This parameter is only available if the "data format" is set to "1 byte scene extension (DPT 18.001)".	
Lower threshold value (H1) (0...255)	0...255
This parameter defines the lower threshold value (H1) of the limit value switch. This parameter is only available if the "data format" is set to "1 byte value -0...255 (DPT 5.010)".	
Lower threshold value (H1) (0...100%)	0...100
This parameter defines the lower threshold value (H1) of the limit value switch. This parameter is only available if the "data format" is set to "1 byte brightness value 0...100 % (DPT 5.001)".	
Lower threshold value (H1) (0...65535)	0...65535
This parameter defines the lower threshold value (H1) of the limit value switch. This parameter is only available if the "data format" is set to "2 byte value 0...65535 (DPT 7.001)".	

Lower threshold value (H1) (-32768...32767)	-32768...0...32767
This parameter defines the lower threshold value (H1) of the limit value switch. This parameter is only available if the "data format" is set to "2 byte value 32768...32767 (DPT 8.001)".	
Lower threshold value (H1) (-671088...670760)	-671088...0...670760
This parameter defines the lower threshold value (H1) of the limit value switch. This parameter is only available if the "data format" is set to "2 byte floating point value (DPT 9.0xx)".	
Lower threshold value (H1) (-2147483648...2147483647)	-2147483648...0...2147483647
This parameter defines the lower threshold value (H1) of the limit value switch. This parameter is only available if the "data format" is set to "4 byte value -2147483648...2147483647 (DPT 13.001)".	
Upper threshold value (H2)	<ul style="list-style-type: none"> dimming darker, stop (0) dimming darker, 100 % (1) dimming darker, 50 % (2) dimming darker, 25 % (3) dimming darker, 12.5 % (4) dimming darker, 6 % (5) dimming darker, 3 % (6) dimming darker, 1.5 % (7) increase brightness, stop (8) increase brightness, 100 % (9) increase brightness, 50 % (10) increase brightness, 25 % (11) increase brightness, 12.5 % (12) increase brightness, 6 % (13) increase brightness, 3 % (14) increase brightness, 1.5 % (15)
This parameter defines the upper threshold value (H2) of the limit value switch. This parameter is only available if the "data format" is set to "4-bit dimming (DPT 3.007)".	

Upper threshold value (H2)	automatic (0) comfort mode (1) standby mode (2) night operation (3) frost/heat protection (4)
This parameter defines the upper threshold value (H2) of the limit value switch. This parameter is only available if the "data format" is set to "1 byte operating mode switchover (DPT 20.102)".	
Upper threshold value (H2)	recall scene 1 (0) recall scene 2 (1) ... recall scene 64 (63) save scene 1 (128) save scene 2 (129) ... save scene 64 (191)
This parameter defines the upper threshold value (H2) of the limit value switch. This parameter is only available if the "data format" is set to "1 byte scene extension (DPT 18.001)".	
Upper threshold value (H2) (0...255)	0...255
This parameter defines the upper threshold value (H2) of the limit value switch. This parameter is only available if the "data format" is set to "1 byte value -0...255 (DPT 5.010)".	
Upper threshold value (H2) (0...100%)	0...100
This parameter defines the upper threshold value (H2) of the limit value switch. This parameter is only available if the "data format" is set to "1 byte brightness value 0...100 % (DPT 5.001)".	
Upper threshold value (H2) (0...65535)	0...65535
This parameter defines the upper threshold value (H2) of the limit value switch. This parameter is only available if the "data format" is set to "2 byte value 0...65535 (DPT 7.001)".	

Upper threshold value (H2) (-32768...32767)	-32768...0...32767
<p>This parameter defines the upper threshold value (H2) of the limit value switch.</p> <p>This parameter is only available if the "data format" is set to "2 byte value 32768...32767 (DPT 8.001)".</p>	
Upper threshold value (H2) (-671088...670760)	-671088...0...670760
<p>This parameter defines the upper threshold value (H2) of the limit value switch.</p> <p>This parameter is only available if the "data format" is set to "2 byte floating point value (DPT 9.0xx)".</p>	
Upper threshold value (H2) (-2147483648...2147483647)	-2147483648...0...2147483647
<p>This parameter defines the upper threshold value (H2) of the limit value switch.</p> <p>This parameter is only available if the "data format" is set to "4 byte value -2147483648...2147483647 (DPT 13.001)".</p>	
Telegram on reaching or exceeding the upper threshold value	ON telegram OFF telegram
<p>The telegram of the output upon reaching or exceeding the upper threshold can be configured here.</p>	
Telegram on falling below the lower threshold value	ON telegram OFF telegram
<p>The telegram of the output upon not reaching the lower threshold can be configured here.</p>	
Transmission criteria	always transmit when the input is updated send only if the output changes transmit cyclically
<p>The transmission behaviour of the output can be configured here.</p> <p>Always transmit when the input is updated: The output transmits the current object value to the KNX with every telegram that is received at the input.</p> <p>Transmit only if the output changes: The output only transmits the current object value if the object value has changed compared to the last transmission process. During the first telegram to an input after bus voltage return or after an ETS programming operation, the output always transmits to an input.</p> <p>transmit cyclically: With this setting, the output transmits the current object value to the KNX cyclically. The cyclical transmission is only started by the first valid trigger after the first telegram has been received at the input. The output also transmits as soon as a new telegram is received at the input. At the same time, the cycle time for cyclical sending is restarted!</p>	

Transmission delay for sending the result hours (0...99)	0...99
<p>An optional delay before result transmission (telegram at output) can be configured. With the setting "always transmit when the input is updated": Telegrams at the output are only transmitted after the trigger when the delay has elapsed. The delay time is restarted by each telegram at the input.</p> <p>With the setting "only transmit if the output changes": Telegrams are only sent when the object value changes at the output if the delay has expired. If the logic function is reprocessed by a new telegram at the input within the delay time and the object value changes again, then the delay restarts. If the object value of the output does not change due to new input telegrams, the delay does not restart.</p> <p>This parameter defines the hours of the delay time.</p>	
Minutes (0...59)	0...59
<p>This parameter defines the minutes of the delay time.</p>	
Seconds (0...59)	0...59
<p>This parameter defines the seconds of the delay time.</p> <p>The parameters for the transmission delay are only visible for "Transmission criteria" = "Always transmit when the input is updated" and "Only transmit when the output changes".</p>	
Cycle time hours (0...99)	0...99
<p>During cyclical transmission of the output, this parameter defines the cycle time. Setting the cycle time hours.</p>	
Minutes (0...59)	0...5...59
<p>This parameter defines the minutes of the cycle time.</p>	
Seconds (0...59)	0...59
<p>This parameter defines the seconds of the cycle time.</p> <p>The parameters for the cycle time are only visible if "transmission criteria" = "transmit cyclically".</p>	

12.6.2 Object list limit value switch

Object no.	Function	Name	Type	DPT	Flag
1002, 1003, 1004, 1005, 1006, 1007, 1008, 1009	Limit value switch Input	Logic... - Input	4-bit	3,007	C, (R), W, -, A
<p>4-bit object as input of a limit value switch.</p> <p>This object is only available if the type of logic function is configured to "limit value switch" and the data format is configured to "4-bit dimming (DPT 3.007)".</p>					

Object no.	Function	Name	Type	DPT	Flag
1018, 1019, 1020, 1021, 1022, 1023, 1024, 1025	Limit value switch Input	Logic... - Input	1 bytes	20,102	C, (R), W, -, A
<p>1-bit object as input of a limit value switch.</p> <p>This object is only available if the type of logic function is configured to "limit value switch" and the data format is configured to "1 byte operating mode switchover (DPT 20.102)".</p>					

Object no.	Function	Name	Type	DPT	Flag
1018, 1019, 1020, 1021, 1022, 1023, 1024, 1025	Limit value switch Input	Logic... - Input	1 bytes	18,001	C, (R), W, -, A
<p>1-bit object as input of a limit value switch.</p> <p>This object is only available if the type of logic function is configured to "limit value switch" and the data format is configured to "1 byte scene extension (DPT 18.001)".</p>					

Object no.	Function	Name	Type	DPT	Flag
1018, 1019, 1020, 1021, 1022, 1023, 1024, 1025	Limit value switch Input	Logic... - Input	1 bytes	5,010	C, (R), W, -, A
<p>1-bit object as input of a limit value switch.</p> <p>This object is only available if the type of logic function is configured to "limit value switch" and the data format is configured to "1-byte value 0...255 (DPT 5.010)".</p>					

Object no.	Function	Name	Type	DPT	Flag
1018, 1019, 1020, 1021, 1022, 1023, 1024, 1025	Limit value switch Input	Logic... - Input	1 bytes	5,001	C, (R), W, -, A

1-bit object as input of a limit value switch.

This object is only available if the type of logic function is configured to "limit value switch" and the data format is configured to "1-byte brightness value 0...100 % (DPT 5.001)".

Object no.	Function	Name	Type	DPT	Flag
1034, 1035, 1036, 1037, 1038, 1039, 1040, 1041	Limit value switch Input	Logic... - Input	2 bytes	7,001	C, (R), W, -, A

2-bit object as input of a limit value switch.

This object is only available if the type of logic function is configured to "limit value switch" and the data format is configured to "2-byte value 0...65535 (DPT 7.001)".

Object no.	Function	Name	Type	DPT	Flag
1034, 1035, 1036, 1037, 1038, 1039, 1040, 1041	Limit value switch Input	Logic... - Input	2 bytes	8,001	C, (R), W, -, A

2-bit object as input of a limit value switch.

This object is only available if the type of logic function is configured to "limit value switch" and the data format is configured to "2-byte value 32768...32767 (DPT 8.001)".

Object no.	Function	Name	Type	DPT	Flag
1034, 1035, 1036, 1037, 1038, 1039, 1040, 1041	Limit value switch Input	Logic... - Input	2 bytes	9,xxx	C, (R), W, -, A

2-bit object as input of a limit value switch.

This object is only available if the type of logic function is configured to "limit value switch" and the data format is configured to "2-byte floating point value (DPT 9.0xx)".

Object no.	Function	Name	Type	DPT	Flag
1050, 1051, 1052, 1053, 1054, 1055, 1056, 1057	Limit value switch Input	Logic... - Input	4 bytes	13,001	C, (R), W, -, A

4-bit object as input of a limit value switch.

This object is only available if the type of logic function is configured to "limit value switch" and the data format is configured to "4-byte value 2147483648...2147483647 (DPT 13.001)".

Object no.	Function	Name	Type	DPT	Flag
1058, 1060, 1062, 1064, 1066, 1068, 1070, 1072	Limit value switch Output	Logic... - Output	1-bit	1,002	C, R, -, T, A

1-bit object as output of a limit value switch. The output object is preset to 1-bit (DPT 1.002) and outputs the result of the threshold evaluation (ON = true / OFF = false).

This object is only available if the type of logic function is configured to "limit value switch".

13 Delivery state

In the as-delivered state, the actuator is passive, i.e. no telegrams are transmitted to the KNX. All relay outputs are set to Venetian blind operation. The outputs can, however, be activated by manual operation on the device, if the bus voltage is on. In the manual control mode, no feedback telegrams are sent to the KNX.

The device can be programmed and put into operation via the ETS. The physical address is preset to 15.15.255

Moreover the device has been configured at the factory with the following characteristics...

- Travel time (continuous run): 1 minute, 0 seconds extended by 20%
- Movement time extension: 2 %
- Break during movement direction changeover: 1 s
- Behaviour in case of bus voltage failure: Stop
- Behaviour in case of bus voltage return: Stop
- Status indication: permanent

i The as-delivered state cannot be restored by unloading the application program with the aid of the ETS. When the application program is removed, all the outputs remain permanently switched off. The manual operation remains without function in this case.

i In the as-delivered state, the relays are switched to the "stop" state when the bus voltage is applied in order to initialise the relays. This short switching operation can be perceived acoustically.

Gira
Giersiepen GmbH & Co. KG
Elektro-Installations-
Systeme

Industriegebiet Mermbach
Dahlienstraße
42477 Radevormwald

Postfach 12 20
42461 Radevormwald

Deutschland

Tel +49(0)21 95 - 602-0
Fax +49(0)21 95 - 602-191

www.gira.de
info@gira.de