

Operating instructions

Dimming actuator 1-gang 200 W with binary input, 3-gang
Order no. 5065 00



Table of Contents

1	Safety instructions	3
2	Device components	4
3	Function	5
4	Information for electrically skilled persons	7
4.1	Mounting and electrical connection	7
4.2	Commissioning	9
5	Technical data	10
6	Troubleshooting	12
7	Accessories	14
8	Parameter list	15
9	Warranty	19

1 Safety instructions



Electrical devices may only be mounted and connected by electrically skilled persons.

Serious injuries, fire or property damage possible. Please read and follow manual fully.

Danger of electric shock. Device is not suitable for disconnection from supply voltage because mains potential even is applied on the load when the output is switched off. Always disconnect before carrying out work on the device or load. To do so, switch off all associated circuit breakers.

Danger of electric shock. Make sure during the installation that there is always sufficient insulation between the mains voltage and the bus. A minimum distance of at least 4 mm must be maintained between bus conductors and mains voltage cores.

Danger of electric shock on the installation. Do not connect any external voltage to the inputs. The device might be damaged, and the SELV potential on the bus line will no longer be available.

Fire hazard. For operation with inductive transformers, each transformer must be fused on the primary side in accordance with the manufacturer's instructions. Only safety transformers according to EN 61558-2-6 may be used.

Risk of destruction of the dimmer and load if the set operating mode and load type do not match. Set the correct dimming principle before connecting or exchanging the load.

This manual is an integral part of the product, and must remain with the end customer.

2 Device components

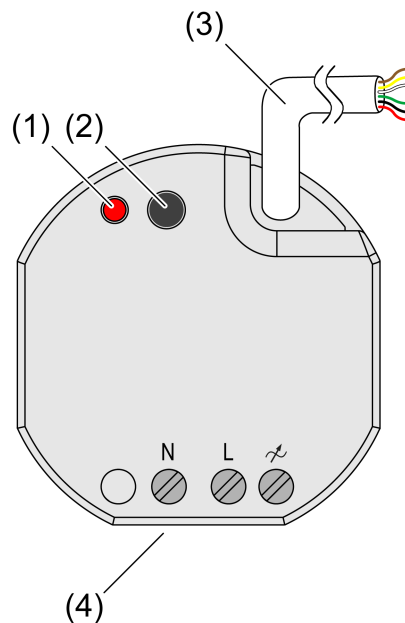

Image 1: Device components

- (1) Programming LED
- (2) Programming button
- (3) Control cable (bus connection and extension inputs)
- (4) Load connection (dimming output)

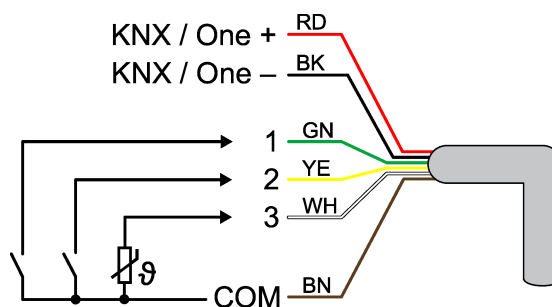

Image 2: Connection assignment of control cable (example)

- | | |
|-------------|---|
| red (RD) | KNX / One + |
| black (BK) | KNX / One - |
| green (GN) | Input 1 (push-button, switch, contact, condensation/leakage sensor) |
| yellow (YE) | Input 2 (push-button, switch, contact, condensation/leakage sensor) |
| white (WH) | Input 3 (push-button, switch, contact, condensation/leakage sensor, NTC temperature sensor) |
| brown (BN) | COM inputs 1...3 |

3 Function

System information

This device is a product for the Gira One Smart Home system. The Gira One system is commissioned easily and in a time-saving manner using the Gira Project Assistant.

The Gira One Smart Home system enables the control and automation of lighting, heating and shading, as well as connection to various third-party systems and much more. It can be operated via Gira One switches, by app from home or securely from a remote location. Electrically skilled persons can maintain the Gira One project remotely free of charge.

Data transmission between the Gira One devices is encrypted. This provides protection against third-party access and manipulation.

Commissioning is carried out with the free Gira Project Assistant (GPA), version 5 or higher. Free function and security updates are also transferred to the Gira One devices with the GPA.

The Gira One system is based on the globally proven KNX smart home standard.

Intended use

- Operation in Gira One system
- Switching and dimming of lighting
- Reading in switching states of installation switches or push-buttons and other potential-free contacts at inputs 1...3
- Signal evaluation of condensation and leakage sensors at inputs 1...3 (see accessory).
- Acquisition of temperature values via NTC temperature sensor at input 3 (see accessories)
- Mounting in appliance box with dimensions according to DIN 49073

Product characteristics

- Output can be operated via the Gira One system or extension inputs
- Three extension inputs for connecting potential-free contacts or dew/leakage sensors. NTC temperature sensor can be connected to input 3.
- Supply via the bus, no additional supply voltage necessary
- Actuator for switching and dimming of incandescent lamps, HV halogen lamps, dimmable HV LED lamps, dimmable compact fluorescent lamps, dimmable inductive transformers with LV halogen or LV LED lamps, dimmable electronic transformers with LV halogen or LV LED lamps.
- Automatic or manual selection of the dimming principle suitable for the load.
- Protected against no-load, short-circuit and overheating.
- Power extension by means of power packs.

- Programming and commissioning with the Gira Project Assistant (GPA), version 5 or higher.
- Updating via the Gira Project Assistant (GPA).
- Encrypted data transmission between the Gira One devices.

Dimming operation characteristics

- Minimum and maximum brightness can be set.
- Switching on to last brightness value or to permanently set switch-on brightness.
- Setting of a switch-on or switch-off delay.
- Staircase function for which a pre-warning time and a pre-warning brightness can optionally be set.

i Flickering of the connected lamps due to undershoot of the specified minimum load or through centralised pulses from the power stations. This does not represent any defect in the device.

Extension input characteristics

- Single or dual-area operation can be configured for rockers.
- Connection of rockers that are configured with the function for switching, dimming, shading and ventilation, scene recall, staircase (motion detector), floor call, garage door and door opener.
- Connection of motion and presence detectors with potential-free relay outputs.
- Convenient group control of switching, dimming, shading and ventilation loads.
- Switching contact evaluation of wind, frost, brightness or rain sensors with potential-free relay outputs possible in order to protect shading and ventilation loads against environmental influences.
- Window contact polling and visualisation in the Smart Home app: An open window leads to the frost protection heating mode after a configured time has elapsed.
- Door contact polling and visualisation in the Smart Home app: An open door leads to the Venetian blind or shutters being raised and locked.
- Polling of a switch-over between heating/cooling at a heat pump in order to be able to forward the current operating mode (heating or cooling) to a heating controller.
- Switching contact indicator for displaying a contact state in the Smart Home app.
- Configurable switching inputs that can be parameterised independently.
- Acquisition and calibration of temperature values via remote sensors (see accessories) at input 3.

4 Information for electrically skilled persons



DANGER!

Mortal danger of electric shock.

Disconnect the device. Cover up live parts.

4.1 Mounting and electrical connection



DANGER!

When connecting the bus/extensions and mains voltage wires in a shared appliance box, the bus line may come into contact with the mains voltage.

This endangers the safety of the entire installation. People at remote devices may also receive an electric shock.

Do not place bus/extensions and mains voltage terminals in a shared connection compartment. Use an appliance box with a fixed partition wall or separate appliance boxes.

Connecting and fitting the device

- Enter or scan the device certificate and add it to the project. A high resolution camera should be used to scan the QR code.
- The device certificate should be removed from the device during mounting.
- Document all passwords and keep them safe.

Mounting in suitable appliance box (recommendation: electronic device box with partition). Observe cable routing and spacing (see figure 3)!

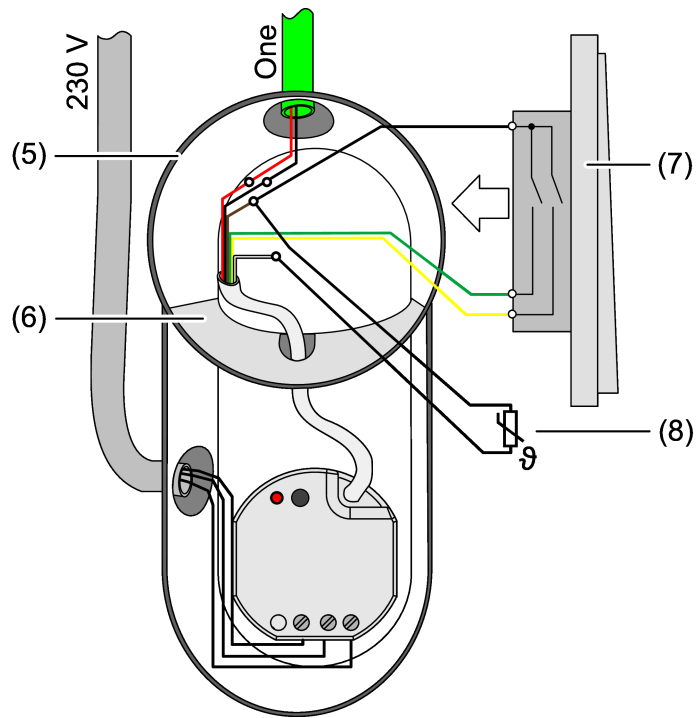

Image 3: Mounting example in electronic appliance box with partition wall, series push-button and NTC temperature sensor

- (5) Appliance box
- (6) Partition
- (7) potential-free contacts (e.g. series push-button)
- (8) NTC temperature sensor (optional)

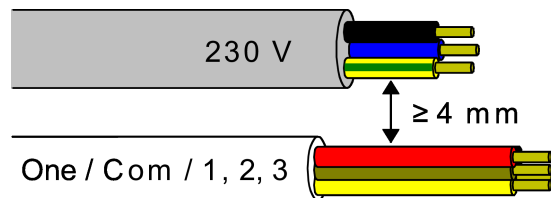

Image 4: Cable spacing

Minimum spacing between the mains voltage and bus/extension wires: 4 mm (see figure 4)

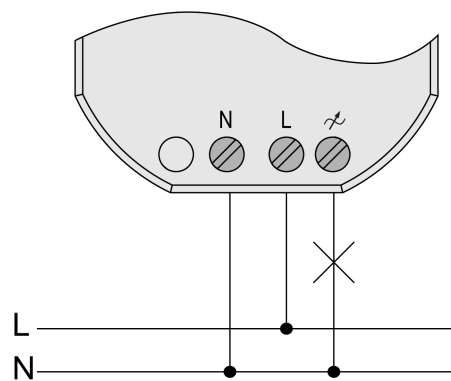

Image 5: Connection of load

Observe ambient temperature. Ensure adequate cooling.

- Connect bus line, observing the correct polarity.
- Connect load as shown in the connection example (see figure 5).
- If required, connect potential-free contacts or condensation/leakage sensors to inputs 1...3, or NTC temperature sensors to input 3 (see figure 2).
- Install the device in the appliance box.

i The COM reference potential must not be connected together with COM connections of other devices!

4.2 Commissioning

Commissioning the device

Delivery state: The output is set to the universal dimming principle with automatic recognition of the load type. Operation of the output is possible via input 1 (ON/Brighter) and input 2 (OFF/Darker). Input 3 has no function.

Function of Inputs in the as-delivered state

Input	Push-button (NO contact)	Function
1	Press briefly (< 0.4 s)	Switch on
1	Press for a long time (> 0.4 s)	Increase brightness
2	Press briefly (< 0.4 s)	Switch off
2	Press for a long time (> 0.4 s)	Reduce brightness
3	---	---

The device is commissioned with the Gira Project Assistant (GPA) version 5 or higher.

Safe-state mode

The safe-state mode stops the execution of the program.

Only the system software of the device is still functional. Diagnosis functions and programming of the device are possible.

Activating safe-state mode

- Switch off the bus voltage or disconnect the device from the bus.
- Wait about 10 s.
- Press and hold down the programming button.
- Switch on the bus voltage or connect the bus again at the device. Release the programming button only after the programming LED starts flashing slowly.

The safe-state mode is activated.

Deactivating safe-state mode

- Switch off the bus voltage (wait approx. 10 s) or carry out programming.

Master reset

The master reset restores the basic device settings (firmware remains in place). The device must then be recommissioned with the GPA.

Performing a master reset

Precondition: The safe-state mode is activated.

- Press and hold down the programming button for > 5 s.
The programming LED flashes quickly.

The device performs a master reset, restarts and is ready for operation again after approx. 5 s.





5 Technical data

Rated voltage	DC 21 ... 32 V SELV
Current consumption	5 ... 18 mA
Connection mode	Device connection terminal on control cable

Output

Rated voltage	AC 230 V ~
Mains frequency	50 / 60 Hz
Power loss	max. 1.5 W
Standby power	approx. 0.2 W
Connection mode	Screw terminals

Connected loads see tables: (see figure 6) and (see figure 7)

	Load types
UNI	universal (with automatic calibration procedure)
	conv. transformer (inductive / leading edge phase control)
LED 	LED (leading edge phase control)
	electr. transformer (capacitive / trailing edge phase control)
LED 	LED (trailing edge phase control)











	 LED	 LED	 LED
25 °C			
	W	W	VA
UNI	1 ... 32	20 ... 100	20 ... 100
 D	1 ... 32	—	20 ... 100
LED  D	1 ... 32	20 ... 100	—
 A	1 ... 200	20 ... 200	—
LED  A	1 ... 200	20 ... 200	—
45 °C			
	W	W	VA
UNI	1 ... 25	20 ... 100	20 ... 100
 D	1 ... 25	—	20 ... 100
LED  D	1 ... 25	20 ... 100	—
 A	1 ... 200	20 ... 200	—
LED  A	1 ... 200	20 ... 200	—

Image 6: Connected load LED lamps











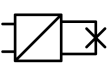

	 	 *	 *
25 °C			
	W	W	VA
UNI	20 ... 230	20 ... 210	20 ... 210
 D	20 ... 210	—	20 ... 210
LED  D	20 ... 210	20 ... 210	—
 A	20 ... 230	20 ... 230	—
LED  A	20 ... 230	20 ... 230	—
45 °C			
	W	W	VA
UNI	20 ... 210	20 ... 160	20 ... 160
 D	20 ... 160	—	20 ... 160
LED  D	20 ... 160	20 ... 160	—
 A	20 ... 210	20 ... 210	—
LED  A	20 ... 210	20 ... 210	—

Image 7: Connected load conventional lamps

Power reduction

when installed in wooden or dry construction walls -15%
 when installed in multiple combinations -20%

Clampable conductor cross-section

Single stranded 0.5 ... 4 mm²
 Finely stranded without conductor sleeve 0.5 ... 4 mm²
 Finely stranded with conductor sleeve 0.5 ... 2.5 mm²
 Connection torque, screw terminals max. 0.8 Nm

Ambient conditions

Ambient temperature	-5 ... +45 °C
Storage/transport temperature	-25 ... +70 °C
Dimensions (W × H × D)	48 x 50 x 28 mm

Inputs

Control cable (preterminated)	YY6x0.6
Input type	Potential-free
Number	3
Total length of extension device cable	max. 10 m
Cable type (preferably)	J-Y(St)Y
Poll voltage, extension inputs	approx. 5 V

6 Troubleshooting**Connected LED lamps or compact fluorescent lamps switch off in the lowest dimming position or flicker**

The set minimum brightness is too low.
Increase minimum brightness.

Connected LED lamps or compact fluorescent lamps flicker

Cause 1: Lamps are not dimmable.

Check manufacturer's instructions.
Exchange lamps for another type.

Cause 2: Dimming principle and lamps do not optimally match.

For HV-LED: Check operation in another dimming principle, reduce connected load as well if necessary.

For LV-LED: Check the lamp operating device and replace as necessary.
With the "Universal" setting: Define the dimming principle manually.

Connected HV-LED lamps or compact fluorescent lamps in the lowest dimming position are too bright; dimming range is too small

Cause 1: The set minimum brightness is too high.

- Reduce minimum brightness.

Cause 2: LED dimming principle (trailing edge phase control) does not optimally match the connected lamps.

- Check operation in the "LED leading edge phase control" setting, reduce connected load as well if necessary.
- Exchange lamps for another type.

Output has switched off.

Cause 1: Overheating protection has tripped.

- Disconnect output from mains, switch off associated circuit breakers.
- LED (trailing edge phase control): Reduce the connected load. Exchange lamps for another type.
- LED (leading edge phase control): Reduce the connected load. Check operation in the setting "LED trailing edge phase control". Exchange lamps for another type.
- Let device cool down for at least 15 minutes. Check installation situation, ensure cooling, e.g. provide distance from surrounding devices.

Cause 2: Overvoltage protection has tripped.

- LED (trailing edge phase control): Check operation in the setting "LED leading edge phase control", reduce connected load as well if necessary.
- Exchange lamps for another type.

Cause 3: short-circuit in output circuit

- Disconnect the output from the mains supply.
- Eliminate short-circuit.
- Switch on mains voltage again. Switch the affected output off and on again.

When a short-circuit occurs the affected output switches off. Automatic restart when short-circuit is eliminated within 100 ms (inductive load) or 7 seconds (capacitive or ohmic load). After that lasting switch-off.

When a short-circuit occurs during the calibration process, the load calibrates itself again after the short-circuit is eliminated.

Cause 4: load failure.

- Check load, replace lamp. For inductive transformers, check primary fuse and replace if necessary.

Output off and not possible to switch on

Cause: bus voltage failure.

Check bus voltage.

Luminaires flicker or buzz, proper dimming not possible, device buzzes

Cause: wrong dimming principle set.

Installation or commissioning error. Disconnect device and luminaire, switch off circuit breaker.

Check installation and correct.

If the wrong dimming principle has been preselected: Set correct dimming principle.

If dimming actuator calibrates itself incorrectly, e.g. with highly inductive mains or long load cables: preselect correct dimming principle with commissioning.

LED lamp is dimly lit when dimmer is switched off

Cause: LED lamp is not optimally suited for this dimmer.

Use a compensation module, see accessories.

Use another type of LED lamp or an LED lamp of another manufacturer.

7 Accessories

Remote sensor (NTC temperature sensor)	1493 00
Condensation sensor	5069 00
Leakage sensor	5068 00

8 Parameter list

Parameters that can be set via the GPA:

Output

Load type	universal (with automatic calibration procedure) electr. transformer (capacitive / trailing edge phase control) conv. transformer (inductive / leading edge phase control) LED (trailing edge phase control) LED (leading edge phase control)
<p>The dimming principle of the dimming channel is specified here.</p> <p>universal (with automatic calibration procedure): The dimming channel automatically sets the connected load type. After programming, after bus voltage return (without mains voltage) or after switching on the mains voltage supply of a load output, the actuator calibrates itself automatically to the connected load. The calibration procedure becomes noticeable during ohmic loads by a brief flicker and lasts up to 10 seconds depending on the network conditions.</p> <p>electr. transformer (capacitive / trailing edge phase control): The dimming channel is set to the trailing edge phase control principle. Ohmic loads or electronic transformers can be connected to the output.</p> <p>conv. transformer (inductive / leading edge phase control): The dimming channel is set to the leading edge phase control principle. Conventional transformers can be connected to the output.</p> <p>LED (trailing edge phase control): The dimming channel is set to an optimised trailing edge phase control principle. HV LED or compact fluorescent lamps optimised for this dimming principle can be connected to the output.</p> <p>LED (leading edge phase control): The dimming channel is set to an optimised leading edge phase control principle. HV LED or compact fluorescent lamps optimised for this dimming principle can be connected to the output.</p>	

Minimum brightness	Level 1 (darker) Level 2 ... Level 7 Level 8 (brighter)
<p>The step value set here is a gauge for the minimum adjustable residual phase angle of the output signal.</p> <p>The value set here cannot be undershot in any switched-on operating state of the dimming channel, i.e. under no circumstances can the light be dimmed darker than the value set here.</p>	

Switch-on brightness	Fixed switch-on brightness Last brightness value
<p>Here you can specify the brightness value with which the lamp is to be switched on by pressing the button briefly:</p> <p>Fixed switch-on brightness In this case, you can select a fixed value (1 - 100%) in the "Switch-on brightness value" field that opens.</p> <p>Last brightness value The lamp is switched on with the brightness value that was active and saved internally before it was last switched off.</p>	

Switch-on brightness value	1 5 ... 100
<p>Here you can specify the switch-on brightness.</p> <p>This parameter is only available if the setting "Fixed switch-on brightness" has been selected for the parameter "Switch-on brightness".</p>	

Maximum brightness value	1 5 ... 100
<p>The value set here cannot be overshoot in any switched-on operating state of the dimming channel, i.e. under no circumstances can the light be dimmed brighter than the value set here.</p>	

Switch-on delay	0 ... 3599 s (0 ... 59:59 min)
<p>This parameter is used for setting the duration of the switch-on delay.</p> <p>After receipt of an ON-telegram, the time that can be configured here is started. The lamp is switched on after the set time has elapsed.</p> <p>A further ON-telegram during the switch-on delay time re-triggers the time, i.e. the time set here is started again.</p> <p>An OFF-telegram received during the ON-delay will end the delay and sets the switching status to "OFF".</p>	

Switch-off delay	0 ... 3599 s (0 ... 59:59 min)
<p>This parameter is used for setting the duration of the switch-off delay.</p> <p>After receipt of an OFF-telegram, the time that can be configured here is started. The lamp is switched off after the set time has elapsed.</p> <p>A further OFF-telegram during the switch-off delay time re-triggers the time, i.e. the time set here is started again.</p> <p>An ON-telegram received during the OFF-delay will end the delay and sets the switching status to "ON".</p>	

Staircase switch switch-off delay	0 ... 65535 s (0 ... 18:12:15 h)
<p>The duration of the switch-on time for the staircase function is configured here.</p> <p>Once the time set here has elapsed, the lighting is switched off or (if configured) the pre-warning time is started.</p> <p>The staircase function is only active if the function "Staircase" has been selected for the push-button of this dimming channel.</p>	

Pre-warning time	0 ... 3599 s (0 ... 59:59 min)
<p>In accordance with DIN 18015-2, the pre-warning is intended to warn persons still on the staircase that the light will soon be switched off automatically.</p> <p>The pre-warning time set here is added to the time set in the parameter "Staircase switch switch-off delay".</p> <p>As a pre-warning, a pre-warning brightness that is to apply before the channel switches off permanently can be set using the parameter "Dimming brightness value". The pre-warning brightness is normally reduced in the brightness value compared to the switch-on brightness.</p>	

Dimming brightness value	1 5 ... 100
<p>Here you can set the brightness value that is to apply during the pre-warning time. During the pre-warning time, the dimming channel is set to the configured brightness value.</p> <p>This parameter is only available if a time has been entered for the parameter "Pre-warning time".</p>	

Input

Debounce time	10 ... 255 ms
<p>This parameter sets the debouncing time individually for the input. According to the time set here, the input signal at the input is evaluated with a delay.</p>	

Contact type	NO contact NC contact
<p>The contact type of the connected contact is defined here.</p>	

When closing the contact	No reaction Switch on Switch off Toggle
<p>This parameter determines the reaction when the contact connected to the input is closed.</p>	

When opening the contact	No reaction Switch on Switch off Toggle
<p>This parameter determines the reaction when the contact connected to the input is opened.</p>	

Temperature calibration	- 12.8 ... 12.7 K
<p>The value for the temperature calibration can be entered here if the temperature measured by the connected sensor differs from the actual room temperature.</p> <p>To determine the temperature deviation, the actual room temperature should be detected with a reference measurement using a calibrated temperature measuring device.</p> <p>The measured value must be raised if the value measured by the sensor is below the actual temperature. The measured value must be lowered if the value measured by the sensor is above the actual temperature.</p>	

9 Warranty

The warranty is provided in accordance with statutory requirements via the specialist trade. Please submit or send faulty devices postage paid together with an error description to your responsible salesperson (specialist trade/installation company/electrical specialist trade). They will forward the devices to the Gira Service Center.

Gira
Giersiepen GmbH & Co. KG
Elektro-Installations-
Systeme

Industriegebiet Mermbach
Dahlienstraße
42477 Radevormwald

Postfach 12 20
42461 Radevormwald

Deutschland

Tel +49(0)21 95 - 602-0
Fax +49(0)21 95 - 602-191

www.gira.de
info@gira.de