

**Universal LED dimming insert Komfort 2-gang**

Order no.: 5402 00

**Operating instructions****1 Safety instructions**

**Installation only by persons with relevant knowledge and experience in the following areas:**

- Five safety regulations and standards for the installation of electrical systems
- Selection of suitable tools, measuring devices, installation materials and, if necessary, personal protective equipment
- Installation of the installation material
- Connection of devices to the building installation under consideration of local connection conditions

Improper installation will endanger your own life and the lives of people using the electrical system, and there will be a risk of serious damage to property, e. g. through fire. You will be at risk of personal liability for personal injury and damage to property.

**Consult an electrically skilled person.**

**Danger of electric shock. The device is not suitable for disconnection from the supply voltage because the mains potential is applied on the load even when the device is switched off. Before carrying out work on the device or load, switch off all corresponding circuit breakers.**

**Risk of destruction of the dimmer and load if the set operating mode and load type do not match. Set the correct dimming principle before connecting or exchanging the load.**

**Fire hazard. For operation with inductive transformers, each transformer must be fused on the primary side in accordance with the manufacturer's instructions. Only safety transformers according to EN 61558-2-6 (VDE 0570 parts 2-6) must be used.**

**Instructions are part of the product. So keep them in a safe place.**

**2 Intended use**

- Switching and dimming of lighting
- Operation with suitable cover
- Mounting in appliance box according to DIN 49073

**3 Product characteristics**

- Two independent outputs for two light groups
- Asymmetric load distribution possible
- The device works according to the leading edge phase control or trailing edge phase control principle
- Automatic or manual setting of the dimming principle suitable for the load
- Indication of the set operating mode by means of LED
- Operation without neutral conductor possible
- Switch-on by bulb-preserving soft start
- Switch on with last brightness set or switch-on brightness saved
- Switch-on brightness can be saved permanently
- Minimum brightness can be saved permanently
- Maximum brightness can be saved permanently
- Connection of extension units possible
- Electronic short-circuit protection with permanent switch-off after 7 seconds at the latest
- Electronic over-temperature protection



Power extension possible by means of power boosters.

## 4 Operation

These instructions describe operation with a series push-button cover. Operation using 3-wire extension unit with series push-button cover essentially corresponds to operation on the main unit. 3-wire extension unit with single push-button cover and rotary dimmer extension only operate output **a1**, 2-wire extension with button cover or push-button for simultaneous operation of both outputs.

- i** Both outputs are always operated simultaneously with a single push-button cover.
- Left: operation of output **a1**.
- Right: operation of output **a2**.

### Switching the light

- Press the push-button cover briefly: Light switches on or off.
- i** 3-wire extension unit: Press top to switch on, press bottom to switch off.

### Setting the brightness

Light is switched on.

- Press and hold the push-button cover at the top.  
The light gets brighter up to maximum brightness.
- Press and hold the push-button cover at the bottom.  
The light gets darker to minimum brightness.

### Switching the light on with minimum brightness

- Press and hold the push-button cover at the bottom.  
The light switches on at minimum brightness.
- Press and hold the push-button cover at the top or the push-button.  
The light switches on at minimum brightness and gets brighter.

### Saving the switch-on brightness

In the state as supplied, the switch-on brightness is set to maximum brightness.

- Set the brightness.
- Press the push-button cover over the entire surface for longer than 4 seconds.  
The switch-on brightness is saved. For confirmation, the light is switched off briefly and switched on again.

### Deleting the switch-on brightness

- Press the push-button cover briefly: Light switches on at the saved switch-on brightness.
- Press the push-button cover over the entire surface for longer than 4 seconds.  
The switch-on brightness is deleted. For confirmation, the light is switched off briefly and switched on again. Switching on takes place with the last brightness value set.

### Operation by push-button as extension unit

Both outputs are operated simultaneously.

- Press the push-button briefly: Light switches on or off.
- Press and hold the push-button: Set the brightness. The dimming direction is changed each time it is pressed and held.
- i** Saving or deleting the switch-on brightness is not possible.

## 5 Information for electrically skilled persons



### DANGER!

Electric shock when live parts are touched.

Electric shocks can be fatal.

Always disconnect the device before carrying out any work on it or the load. To do so, switch off all corresponding circuit breakers, secure them against being switched on again and check that there is no voltage. Cover up any adjacent live parts.

### Mounting and electrical connection



### CAUTION!

Device fault if both outputs are connected to a common load.

Do not connect outputs to a common load. For power extension, use power boosters.

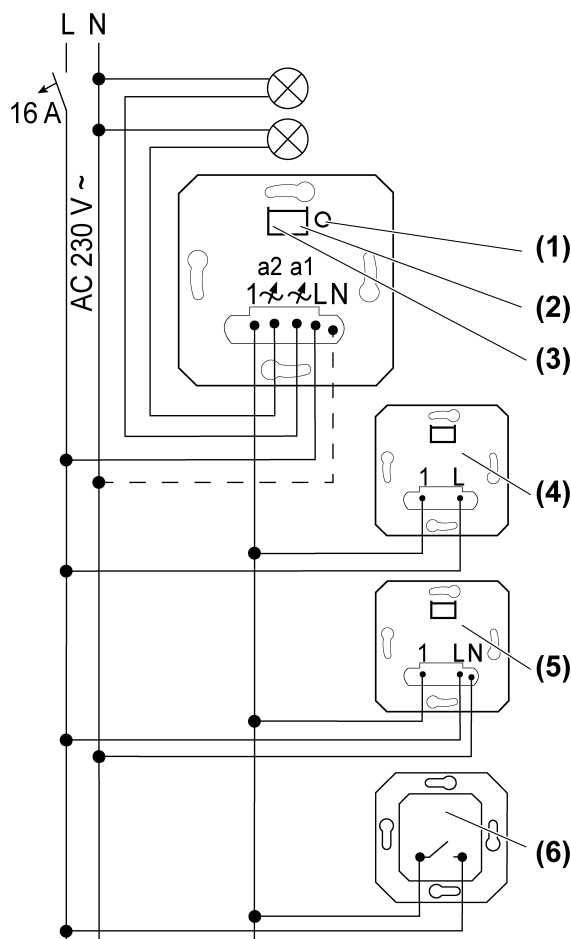

Figure 1: Connection diagram with optional extension units

- (1) Dimming mode button
- (2) Indication LED output 2
- (3) Indication LED output 1
- (4) 2-wire extension unit
- (5) 3-wire extension unit, rotary extension unit

## (6) Push-button, NO contact

Connect 600 W LED lamps or compact fluorescent lamps at most per 16 A circuit breaker.

When connecting transformers, observe the data of the transformer manufacturer.

Operation without neutral conductor possible.

Observe the conductor cross-sections (see technical data).

Lit push-buttons must have a separate N connection terminal.

The light for both outputs can be switched by briefly actuating the Dimming mode button (switching states: **a1** on **a2** off, **a1** off **a2** on, **a1** and **a2** on, **a1** and **a2** off).

An operational lamp must be connected to output **a1**, otherwise the dimmer will not function.

The dimmer takes into account the different electronic characteristics of most dimmable LED lamps on the market. However, it cannot be guaranteed that in individual cases the desired results may not be achieved.

**Resetting the overheating protection / short-circuit protection**

Disconnect the dimmer from the mains supply.

**Operating mode: Universal, R,L,C,LED (factory setting)**

- Automatic calibration to the load, dimming principle, trailing edge phase control, leading edge phase control or LED leading edge phase control
- Incandescent lamps, HV halogen lamps, dimmable HV-LED or compact fluorescent lamps, dimmable electronic or inductive transformers for halogen or LED lamps.

**Operating mode: LED trailing edge phase control, LED **

**i** The connection of inductive transformers is not permitted.

- Incandescent lamps, HV halogen lamps, electronic transformers for halogen or LED lamps that can be dimmed according to the trailing edge phase control principle, HV-LED or compact fluorescent lamps that can be dimmed according to the trailing edge phase control principle.

**Operating mode: LED leading edge phase control, LED **

**i** The connection of inductive transformers is not permitted.

- Incandescent lamps, HV halogen lamps, electronic transformers for halogen or LED lamps that can be dimmed according to the leading edge phase control principle, HV-LED or compact fluorescent lamps that can be dimmed according to the leading edge phase control principle.

**Setting the operating mode and minimum brightness**

The operating mode and minimum brightness can be individually set for each output. To do this, carry out the following steps separately for each output.

**i** Set the minimum brightness so that the lamp lights up visibly in the lowest dimming position and when switched on at minimum brightness.

Prerequisite: The light on both outputs is switched off.

- Press the **Dimming mode** button (1) for longer than 4 seconds, until the LEDs (2) and (3) light up (Figure 1).



| LED              | Dimm-Mode   |
|------------------|---|
| GN (grün, green) | R,L,C,LED   |
| RD (rot, red)    | LED  |
| BU (blau, blue)  | LED  |

Figure 2: Assignment of LED colour to dimming principle

- Keep briefly pressing the **Dimming mode** button (1) until the necessary operating mode is selected for an output.

LED (2) lights up in the colour of the selected operating mode, dimming principle for output two is set (Figure 2),

or

LED (3) lights up in the colour of the selected operating mode, dimming principle for output one is set (Figure 2)

- Press the **dimming mode** button (1) for longer than 1 second and keep it pressed. When changing the operating mode to universal, the calibration to the load is first performed. Keep the Dimming mode (1) button pressed. LED (2) or (3) flashes. The light of the corresponding output switches on at half brightness and slowly dims.
- Once the desired minimum brightness is reached, release the **Dimming mode** button (1). LED (2) or (3) lights up, operating mode and minimum brightness are set.
- Optionally change the minimum brightness again: Press the **dimming mode** button (1) again for longer than 1 second.
- Save the settings: Press the **dimming mode** button (1) for less than 1 second or do not press it for 30 seconds. LED (2) or (3) goes out.

### Setting the maximum brightness

The maximum brightness can be set individually for each output. To do this, carry out the following steps separately for each output.

- Press the **dimming mode** button (1) briefly until only the light of the output to be set is switched on.
- Press the **dimming mode** button (1) for longer than 4 second and keep it pressed. LED (2) or (3) flashes. The light of the corresponding output switches on to maximum brightness and slowly dims.
- As soon as the desired maximum brightness is reached, release the **dimming mode** button (1).
- Optionally change the maximum brightness again: Press the **dimming mode** button (1) again for longer than 1 second.
- Save the setting: Press the **dimming mode** button (1) for less than 1 second or do not press it for 30 seconds. The LED (2) goes out.

## 6 Technical data

|                                     |                       |
|-------------------------------------|-----------------------|
| Rated voltage                       | AC 230 V ~            |
| Mains frequency                     | 50 / 60 Hz            |
| Standby load depending on the cover | approx. 0.1 ... 0.5 W |
| Power loss                          | Approx. 4 W           |
| Ambient temperature                 | -5 ... +45 °C         |
| Connected load per output at 25°C   | See table 1           |

Operating mode **LED** : max. connected load for HV-LED lamps typ. 3 ... 100 W, electronic transformers with LV-LED typ. 20 ... 100 W.

|                            |                 |
|----------------------------|-----------------|
| Mixed load per output      |                 |
| ohmic-capacitive           | 20 ... 210 W    |
| capacitive-inductive       | not permitted   |
| ohmic-inductive            | 20 ... 210 VA   |
| ohmic and HV LED           | typ. 3 ... 50 W |
| ohmic and compact fl lamp. | typ. 3 ... 50 W |

 Power specifications including transformer dissipation.

Universal LED dimming insert Komfort 2-gang

- i** Operate inductive transformers with at least 85% nominal load.
- i** Ohmic-inductive mixed load: max. 50% proportion of ohmic load. Otherwise, an incorrect measurement is possible.
- i** Operation without neutral conductor: Minimum load 50 W. Does not apply to loads with HV-LED and compact fluorescent lamps.

Power reduction

|  |      |
|--|------|
| per 5 °C in excess of 25 °C                        | -10% |
| when installed in wooden or dry construction walls | -15% |
| when installed in multiple combinations            | -20% |

Power boosters

see power booster instructions

Number of extension units

2-wire, push-button unlimited

3-wire extension, rotary extension 10

Total length of extension device cable Max. 100 m

Total length of power cable Max. 100 m

Clampable conductor cross-section (Figure 3)

Installation depth 30 mm

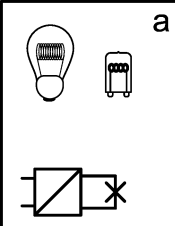
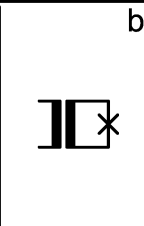
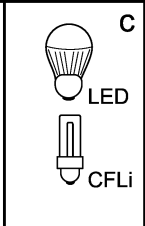
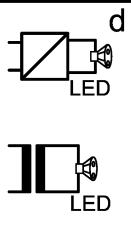
|   |   |  |   |
|---|---|--|---|
|  <p>a</p> |  <p>b</p> |  <p>c</p> |  <p>d</p> |
| W   | VA  | W  | W/VA  |
| 20 ... 210  | 20 ... 210  | 3 ... 50   | 20 ... 50   |

- a Incandescent lamps, HV halogen lamps, electronic transformer with LV halogen lamps
- b Inductive transformer with LV halogen lamps
- c HV-LED lamps, compact fluorescent lamps
- d Electronic LED ballast with LED lamps; Inductive transformer with LED lamps

Table 1: lamp loads

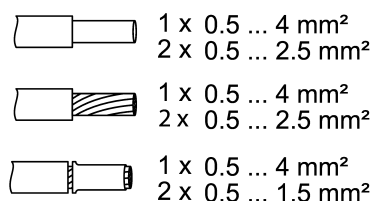

Figure 3: Clampable conductor cross-section

## 7 Troubleshooting

### **Dimmer has no function**

Cause: output **a1** is not ready for operation.

- Check the load at output **a1**.

### **Connected LED lamps or compact fluorescent lamps switch off in the lowest dimming position or flicker**

Cause: The set minimum brightness is too low.

- Increase minimum brightness.

### **Connected lamps do not switch on in the lowest dimming position or only after a delay**

Cause: The set minimum brightness is too low.

- Increase minimum brightness.

### **Connected LED lamps or compact fluorescent lamps flicker or buzz, no correct dimming possible, device buzzes**

Cause 1: Lamps are not dimmable.

- Check manufacturer's instructions.
- Exchange lamps for another type.

Cause 2: Operating mode (dimming principle) and lamps do not optimally match.

- Check operation in another operating mode, reduce connected load as well if necessary.
- Set the operating mode manually.
- Exchange lamps for another type.

Cause 3: Dimmer is connected without neutral conductor.

- Connect neutral conductor if possible, otherwise exchange lamp for another type.

### **Connected LED lamps or compact fluorescent lamps in the lowest dimming position are too bright; dimming range is too small**

Cause 1: The set minimum brightness is too high.

- Reduce minimum brightness.

Cause 2: Operating mode (dimming principle) does not optimally match the connected HV-LED lamps.

- Check operation in another operating mode, reduce connected load as well if necessary.
- Set the operating mode manually.
- Exchange HV-LED lamps for another type.

### **The dimmer switches the load off briefly and then on again.**

Cause: Short-circuit protection has tripped but now there is no longer a fault.

### **The dimmer has switched off and the load cannot be switched on again**

Cause 1: Overheating protection has tripped.

- Disconnect dimmer from mains by switching off circuit breaker.
- LED trailing edge phase control: Reduce the connected load. Exchange lamps for another type.
- LED leading edge phase control: Reduce the connected load. Check operation in the LED trailing edge phase control setting. Exchange lamps for another type.
- Let dimmer cool down for at least 15 minutes.
- Switch circuit breakers and dimmer on again.

Cause 2: Overvoltage protection has tripped.

- LED trailing edge phase control: Check operation in the LED leading edge phase control setting, reduce connected load as well if necessary.
- Exchange lamps for another type.

Cause 3: Short-circuit protection has tripped.

- Disconnect dimmer from mains by switching off circuit breaker.
- Eliminate short-circuit.
- Switch circuit breakers and dimmer on again.

**i** Short-circuit protection is not based on a conventional fuse, no metallic separation of the operational current.

Cause 4: load failure.

- Check load, replace lamp. For inductive transformers, check primary fuse.

### **LED lamp is dimly lit when dimmer is switched off**

Cause: LED lamp is not optimally suited for this dimmer.

- Use a compensation module, see accessories.
- Use another type of LED lamp or an LED lamp of another manufacturer.

## **8 Accessories**

Operating top unit 2-gang

Order no. 5362 ..

Operating top unit

Order no. 5360 .., 5361 ..

Compensation module LED

Order no. 2375 00

## **9 Warranty**

The warranty is provided by the specialist trade in accordance with statutory requirements. Please submit or send faulty devices postage paid together with a fault description to your responsible salesperson (specialist trade / installation company / electrical specialist trade). They will forward the devices to the Gira Service Center.

**Gira**  
**Giersiepen GmbH & Co. KG**  
 Elektro-Installations-  
 Systeme

Industriegebiet Mermbach  
 Dahlienstraße  
 42477 Radevormwald

Postfach 12 20  
 42461 Radevormwald

Deutschland

Tel +49(0)21 95 - 602-0  
 Fax +49(0)21 95 - 602-191

www.gira.de  
 info@gira.de